

CHEVROLET 



2023
SILVERADO 1500

STRONGER THAN EVER.

The legend of Chevy Silverado takes another step forward.

First, we partnered with American Expedition Vehicles (AEV) to take the already formidable ZR2 and elevate it into the ultimate off-road beast with the Bison Edition. Next, we took a powerful engine lineup and enhanced the available Duramax® 3.0L Turbo-Diesel engine with even more horsepower and torque.

Add to that available advanced trailering technologies, a standard Durabed and the hardworking capability of Silverado and you have the strength to handle whatever comes next.



Silverado Crew Cab Short Bed ZR2 in Glacier Blue Metallic (extra-cost color) with available features.

AT A GLANCE.

- Nine models: WT, Custom, Custom Trail Boss, LT, RST, LT Trail Boss, LTZ, ZR2 and High Country
- 2.7L Turbo High-Output engine and 8-speed transmission: 310 horsepower and 430 lb.-ft. of torque
- Available 5.3L EcoTec3 V8 and 10-speed transmission: 355 horsepower and 383 lb.-ft. of torque
- Available 6.2L EcoTec3 V8 and 10-speed transmission: 420 horsepower and 460 lb.-ft. of torque
- Available Duramax 3.0L Turbo-Diesel I-6 and 10-speed transmission: 305 horsepower and 495 lb.-ft. of torque; offers an EPA-estimated 29 MPG highway¹
- 13,300 lbs. maximum trailering weight²
- 2,260 lbs. maximum payload³
- Available Trailering App⁴ and myChevrolet Mobile App with Trailering⁵
- 8 available cameras with up to 14 unique views^{6,7} – see page 9 for more information
- Available six-function Multi-Flex Tailgate or power-up/-down tailgate
- Cargo volume:⁸ Long Bed: 89.1 cu. ft.; Standard Bed: 71.7 cu. ft.; Short Bed: 62.9 cu. ft.
- LT and above include 13.4-inch diagonal color touch-screen display and 12.3-inch diagonal reconfigurable Driver Information Center
- Available Super Cruise^{TM9} hands-free driver assistance technology with Trailering



The Silverado off-road family.



13.4-inch diagonal touch-screen display on LT and above.

¹ EPA-estimated MPG city/highway: 24/29 (2WD), 22/27 (4x4), 21/23 (Trail Boss 4x4). ² Requires Silverado Double Cab 2WD with available Duramax 3.0L Turbo-Diesel engine, Max Trailering Package and 18" or 20" wheels or Silverado Double Cab Standard Bed RST 4x4 with available 6.2L V8 engine, Max Trailering Package and 20" wheels. Maximum trailering ratings are intended for comparison purposes only. Before you buy a vehicle or use it for trailering, carefully review the Trailering section of the Owner's Manual. The trailering capacity of your specific vehicle may vary. The weight of passengers, cargo and options or accessories may reduce the amount you can trailer. ³ Requires Silverado Regular Cab Standard Bed or Long Bed 2WD with 2.7L Turbo High-Output engine. For comparison purposes only. See the Owner's Manual and the label on the vehicle door jamb for the carrying capacity of a specific vehicle. ⁴ App functionality and features vary with vehicle equipment and trim level. Data connection may be required. Some features require active service plan and working electrical system. User terms and limitations apply. ⁵ Available on select Apple and Android devices. Service availability, features and functionality vary by vehicle, vehicle equipment, trim level, device and the plan you are enrolled in. Some features may require a working electrical system. User terms apply. Device data connection required. Visit onstar.com for details and limitations. ⁶ Safety or driver assistance features are no substitute for the driver's responsibility to operate the vehicle in a safe manner. Read the vehicle Owner's Manual for important feature limitations and information. ⁷ Some camera views require available accessory camera and installation. Not compatible with all trailers. See your dealer for details. ⁸ Cargo and load capacity limited by weight and distribution. ⁹ Always pay attention while driving and when using Super Cruise. Do not use a hand-held device. Requires active Super Cruise plan or trial. Terms apply. Visit chevroletssuperdrive.com for compatible roads and full details.

SILVERADO ZR2.

- Silverado-first application of Multimatic DSSV™ dampers for enhanced wheel travel
- 6.2L EcoTec3 V8 engine with 420 horsepower and 460 lb.-ft. of torque
- 10-speed automatic transmission with Electronic Transmission Range Selector and steering column paddle shifters
- Off-road cut front bumper that enables an improved 31-degree approach angle
- Steel front and rear bumpers designed for off-road strength, durability and clearance
- Enhanced 2-speed transfer case includes Terrain mode with one-pedal¹ rock crawling in low range
- Off-road chassis and suspension calibrations
- Large underbody aluminum skid plates allow for optimized off-road capability
- Front and rear electronic locking differentials
- 33-inch Goodyear Wrangler Territory® mud-terrain tires
- Raised hood with styled Black insert
- Black chrome grille with Chevy flowtie badge
- ZR2-specific Graystone/Jet Black interior trim with Strike Yellow accent stitching
- New available ZR2 Bison Edition includes American Expedition Vehicles (AEV) stamped-steel front and rear bumpers, five hot-stamped Boron steel skid plates, off-road rocker protection, 18-inch off-road aluminum wheels with AEV center caps, AEV-embroidered head restraints and AEV-branded floor liners



Silverado Crew Cab Short Bed ZR2 in Glacier Blue Metallic (extra-cost color) with available features.



Silverado Crew Cab Short Bed ZR2 in Summit White with available ZR2 Bison Edition.

¹ Always use the brake pedal if you need to stop immediately.



NINE MODELS TO CHOOSE FROM.



WT

The workday workhorse.

- 2.7L Turbo High-Output or available 5.3L V8 engine
- Chevrolet graphic grille and tailgate
- Blacked-out grille and trim
- Durabed featuring 12 standard tie-downs
- Rear Vision Camera¹
- CornerStep rear bumper
- Durable vinyl or available cloth seats and a rubberized-vinyl floor for easy cleanup
- 40/20/40 split-bench front seat with covered armrest storage and underseat storage
- Single-zone semi-automatic climate control
- Apple CarPlay^{®2} and Android Auto^{™3} compatibility
- Two USB ports⁴ on instrument panel
- Push-Button Start and Remote Keyless Entry
- Chevy Safety Assist⁵
- Available [WT Convenience Package](#)
- Available [WT Safety Package](#)



CUSTOM

All the style. All the value.

- 2.7L Turbo High-Output engine
- 20-inch Bright Silver-painted aluminum wheels
- Body-color bumpers and Black grille bar
- EZ Lift power lock and release tailgate
- Heated power-adjustable outside mirrors
- Remote vehicle starter system
- Wireless Apple CarPlay² and wireless Android Auto³ compatibility
- 10-way power driver seat including lumbar control
- [Trailerling Package](#)
- [Custom Value Package](#)

Available Special Edition
[Rally Edition](#)



CUSTOM TRAIL BOSS

Ready to take on every off-road adventure.

- 2.7L Turbo High-Output or available 5.3L V8 or Duramax 3.0L Turbo-Diesel I-6 engine
- 2-inch factory suspension lift
- Z71 Off-Road suspension, monotube shocks, Hill Descent Control, skid plates and Z71 badge
- Autotrac[®] 2-speed transfer case
- Automatic locking rear differential
- 18-inch high-gloss Black-painted wheels with Goodyear Wrangler DuraTrac[®] mud-terrain tires
- Raised hood with styled Black insert
- High-gloss Black bumpers
- Performance Red recovery hooks⁶
- [Custom Convenience Package](#)

Available Special Editions
[Realtree[®] Special Edition](#)
[Midnight Edition](#)

¹ Safety or driver assistance features are no substitute for the driver's responsibility to operate the vehicle in a safe manner. Read the vehicle Owner's Manual for important feature limitations and information. ² Vehicle user interface is a product of Apple and its terms and privacy statements apply. Requires compatible iPhone and data plan rates apply. ³ Vehicle user interface is a product of Google and its terms and privacy statements apply. To use Android Auto on your car display, you'll need an Android phone running Android 6 or higher, an active data plan, and the Android Auto app. ⁴ Not compatible with all devices. ⁵ Chevy Safety Assist includes Automatic Emergency Braking, Front Pedestrian Braking, Lane Keep Assist with Lane Departure Warning, Forward Collision Alert, IntelliBeam and Following Distance Indicator. Safety or driver assistance features are no substitute for the driver's responsibility to operate the vehicle in a safe manner. Read the vehicle Owner's Manual for important feature limitations and information. ⁶ To avoid the risk of injury, never use recovery hooks to tow a vehicle. For more information, see the Recovery Hooks section of your Owner's Manual.

Apple CarPlay, Siri, iPhone and Apple Music are trademarks of Apple Inc., registered in the U.S. and other countries. Google, Android and Android Auto are trademarks of Google LLC.

NINE MODELS TO CHOOSE FROM.



LT

Essential truck appeal. Silverado capability.

- 2.7L Turbo High-Output or available 5.3L V8 or Duramax 3.0L Turbo-Diesel I-6 engine
- 13.4-inch diagonal color touch-screen display and Google built-in¹ compatibility
- 12.3-inch diagonal reconfigurable Driver Information Center
- Chrome grille bar, bumpers and mirror caps
- LED headlamps and daytime running lamps (DRLs) with Amber tracer animation
- Dual-zone automatic climate control
- Keyless Open and Start
- Leather-wrapped steering wheel
- [All Star Edition](#)
- [Convenience Package](#)
- Available Multi-Flex Tailgate or power-up/-down tailgate
- Available 20-inch machined-face painted-aluminum wheels with Grazen-painted pockets
- Available in-vehicle Trailerling App²
- Available [All Star Edition Plus](#)



RST

Get ready to get noticed.

- 2.7L Turbo High-Output (standard on Double Cab) or 5.3L V8 (standard on Crew Cab); available 6.2L V8 or Duramax 3.0L Turbo-Diesel I-6 engine
- 13.4-inch diagonal color touch-screen display and Google built-in¹ compatibility
- 12.3-inch diagonal reconfigurable Driver Information Center
- Body-color grille bar, bumpers and door handles
- Black Chevrolet bowtie emblems
- [All Star Edition](#)
- [Convenience Package](#)
- Available Multi-Flex Tailgate or power-up/-down tailgate
- Available in-vehicle Trailerling App²
- Available [Leather Package](#)
- Available [RST All Star Premium Package](#)

Available Special Editions

[Rally Edition](#)

[Redline Edition](#)



LT TRAIL BOSS

Blending an iconic appearance with off-road ability.

- 2.7L Turbo High-Output or available 5.3L V8 or 6.2L V8 or Duramax 3.0L Turbo-Diesel I-6 engine
- 13.4-inch diagonal color touch-screen display and Google built-in¹ compatibility
- 12.3-inch diagonal reconfigurable Driver Information Center
- 2-inch factory suspension lift
- Z71 Off-Road suspension, monotube shocks, Hill Descent Control, skid plates and Z71 badge
- Autotrac 2-speed transfer case
- Automatic locking rear differential
- 18-inch high-gloss Black-painted wheels with Goodyear Wrangler DuraTrac[®] mud-terrain tires
- Available 20-inch high-gloss Black-painted wheels with Goodyear Wrangler Territory[®] mud-terrain tires
- Raised hood with styled Black insert
- All-weather floor liners with Z71 logo
- Available [LT Trail Boss Premium Package](#)

Available Special Edition

[Midnight Edition](#)

NINE MODELS TO CHOOSE FROM.



LTZ

This pickup doesn't compromise on style or capability.

- 5.3L V8 or available 6.2L V8 or Duramax 3.0L Turbo-Diesel I-6 engine
- 10-speed automatic transmission with Electronic Transmission Range Selector
- 20-inch painted-aluminum wheels
- Power-up/-down tailgate or available Multi-Flex Tailgate
- High-intensity LED reflector headlamps with LED curtain DRLs and White tracer animation
- Advanced trailering camera system offering 8 available cameras with up to 14 views¹
- Perforated leather-appointed front bucket seats
- Bose premium 7-speaker audio system
- HD Surround Vision²
- Rear Cross Traffic Braking², Trailer Side Blind Zone Alert² and Rear Pedestrian Alert²
- [LTZ Plus Package](#)
- Available [LTZ Premium Package](#)
- Available [Technology Package](#)



ZR2

Make sure your off-road game is on point.

- 6.2L V8 engine
- 10-speed automatic transmission with Electronic Transmission Range Selector
- Multimatic DSSV™ dampers
- Off-road chassis and suspension calibrations
- Front and rear electronic locking differentials
- Large underbody aluminum skid plates
- Enhanced 2-speed transfer case with Terrain mode
- 33-inch Goodyear Wrangler Territory® mud-terrain tires with ZR2-specific 18-inch aluminum wheels
- Raised hood with styled Black insert
- High-intensity LED reflector headlamps with Black bezels, LED curtain DRLs and White tracer animation
- Exclusive Graystone/Jet Black interior trim with Strike Yellow accent stitching
- Rear Cross Traffic Braking², Trailer Side Blind Zone Alert² and Rear Pedestrian Alert²

Available Special Edition
[ZR2 Bison Edition](#)



HIGH COUNTRY

You've reached the top. High Country is your reward.

- 5.3L V8 or available 6.2L V8 or Duramax 3.0L Turbo-Diesel I-6 engine
- Exclusive Galvano grille with Black accents
- Leather seating surfaces with exclusive custom perforation and stitching pattern
- Authentic open-pore wood trim
- Bose premium 7-speaker audio system
- Power-up/-down tailgate or available Multi-Flex Tailgate
- Available power-retractable assist steps
- 20-inch machined-aluminum or available 22-inch painted-aluminum wheels
- High-intensity LED reflector headlamps with LED curtain DRLs and White tracer animation
- Bed View Camera²
- Available Super Cruise³ hands-free driver assistance technology with Trailering
- Available [Technology Package](#)
- Available [High Country Premium Package](#)

¹ Safety or driver assistance features are no substitute for the driver's responsibility to operate the vehicle in a safe manner. Read the vehicle Owner's Manual for important feature limitations and information. Some camera views require available accessory camera and installation. Not compatible with all trailers. See your dealer for details. ² Safety or driver assistance features are no substitute for the driver's responsibility to operate the vehicle in a safe manner. Read the vehicle Owner's Manual for important feature limitations and information. ³ Always pay attention while driving and when using Super Cruise. Do not use a hand-held device. Requires active Super Cruise plan or trial. Terms apply. Visit [chevrolet.com/supercruise.com](https://chevrolet.com/supercruise) for compatible roads and full details.

THE STRENGTH OF TOWING CONFIDENCE.

Silverado offers integrated towing technologies that help deliver confidence and make towing big loads easy.

- Available advanced trailering features include:
 - Hitch Guidance with Hitch View¹
 - Hitch area lighting
 - Electric Parking Brake hookup assist
 - Integrated trailer brake controller
 - Trailer Theft Alert
 - myChevrolet Mobile App² with Trailering
- Available Trailering App³ offers:
 - Customized trailer profiles
 - Pre-departure checklists
 - Trailer lighting diagnostics
 - Trailer tire pressure/temperature monitoring⁴
- Standard trailering features include:
 - StabiliTrak[®] with Trailer Sway Control and Hill Start Assist
 - Tow/Haul mode
 - Auto Grade Braking
 - Trailering Information Label
- Available camera technology¹ features include:
 - Jack-Knife Alert
 - Bed View with Cargo Bed Zoom and Bed Hitch Guidance



Silverado Crew Cab Short Bed LTZ 4x4 in Radiant Red Tintcoat (extra-cost color) with available features.



Available Jack-Knife Alert warning.

Trailering Guide >

¹ Safety or driver assistance features are no substitute for the driver's responsibility to operate the vehicle in a safe manner. Read the vehicle Owner's Manual for important feature limitations and information. ² Available on select Apple and Android devices. Service availability, features and functionality vary by vehicle, vehicle equipment, trim level, device and the plan you are enrolled in. Some features may require a working electrical system. User terms apply. Device data connection required. Visit onstar.com for details and limitations. ³ App functionality and features vary with vehicle equipment and trim level. Data connection may be required. Some features require active service plan and working electrical system. User terms and limitations apply. ⁴ Requires available Trailer Tire Pressure Monitor Sensors.

8 AVAILABLE CAMERAS WITH UP TO 14 UNIQUE VIEWS!

From hitching to driving to parking, Silverado offers advanced camera technologies that are designed to help make your towing job easier from start to finish. Available on Silverado LT, RST, LT Trail Boss, LTZ, ZR2 and High Country.

Safety or driver assistance features are no substitute for the driver's responsibility to operate the vehicle in a safe manner. The driver should remain attentive to traffic, surroundings and road conditions at all times. Visibility, weather and road conditions may affect feature performance. Read the vehicle Owner's Manual for more important feature limitations and information.

¹ Requires available Chevrolet Accessory Camera and installation. Not compatible with all trailers. Customers can see their dealer for full details. ² Not available on LT, RST or LT Trail Boss.

- Four available hitch views:

- Hitch View

- Surround View

- Rear Top-Down View

- Bed View

- Six available driving views:

- Transparent Trailer View¹

- Front Camera View

- Pic-In-Pic Side View¹

- Rear Camera Mirror²

- Rear Trailer View¹

- Inside Trailer View¹

- Four available parking views:

- Rear Camera View

- Rear Side View/Rear Side View (Turn-Signal Activated)

- Front Side View

- Front Top-Down View



Available Surround View.



Available Transparent Trailer View!

Camera Technologies >

MODEL AVAILABILITY

● STANDARD – NOT AVAILABLE

REGULAR CAB – STANDARD BED



MODEL	STANDARD ENGINE	AVAILABLE ENGINES	2WD	4x4
WT	2.7L Turbo High-Output	–	●	●

REGULAR CAB – LONG BED



MODEL	STANDARD ENGINE	AVAILABLE ENGINES	2WD	4x4
WT	2.7L Turbo High-Output	5.3L EcoTec3 V8	●	●

DOUBLE CAB – STANDARD BED



MODEL	STANDARD ENGINE	AVAILABLE ENGINES	2WD	4x4
WT	2.7L Turbo High-Output	5.3L EcoTec3 V8	●	●
Custom	2.7L Turbo High-Output	–	●	●
LT	2.7L Turbo High-Output	5.3L EcoTec3 V8, Duramax 3.0L I-6	●	●
RST	2.7L Turbo High-Output	5.3L EcoTec3 V8, 6.2L EcoTec3 V8, Duramax 3.0L I-6	–	●

CREW CAB – SHORT BED



MODEL	STANDARD ENGINE	AVAILABLE ENGINES	2WD	4x4
WT	2.7L Turbo High-Output	5.3L EcoTec3 V8	●	●
Custom	2.7L Turbo High-Output	–	●	●
Custom Trail Boss	2.7L Turbo High-Output	5.3L EcoTec3 V8, Duramax 3.0L I-6	–	●
LT	2.7L Turbo High-Output	5.3L EcoTec3 V8, Duramax 3.0L I-6	●	●
RST	5.3L EcoTec3 V8	6.2L EcoTec3 V8 ¹ ; Duramax 3.0L I-6	●	●
LT Trail Boss	2.7L Turbo High-Output	5.3L EcoTec3 V8, 6.2L EcoTec3 V8, Duramax 3.0L I-6	–	●
LTZ	5.3L EcoTec3 V8	6.2L EcoTec3 V8; Duramax 3.0L I-6	●	●
ZR2	6.2L EcoTec3 V8	–	–	●
High Country	5.3L EcoTec3 V8	6.2L EcoTec3 V8; Duramax 3.0L I-6	●	●

CREW CAB – STANDARD BED



MODEL	STANDARD ENGINE	AVAILABLE ENGINES	2WD	4x4
WT	2.7L Turbo High-Output	5.3L EcoTec3 V8	●	●
Custom	2.7L Turbo High-Output	–	–	●
Custom Trail Boss	2.7L Turbo High-Output	5.3L EcoTec3 V8, Duramax 3.0L I-6	–	●
LT	2.7L Turbo High-Output	5.3L EcoTec3 V8, Duramax 3.0L I-6 ¹	●	●
RST	5.3L EcoTec3 V8	6.2L EcoTec3 V8	–	●
LT Trail Boss	2.7L Turbo High-Output	5.3L EcoTec3 V8, 6.2L EcoTec3 V8, Duramax 3.0L I-6	–	●
LTZ	5.3L EcoTec3 V8	6.2L EcoTec3 V8, Duramax 3.0L I-6	–	●
High Country	5.3L EcoTec3 V8	6.2L EcoTec3 V8, Duramax 3.0L I-6	–	●

¹ Requires available 4x4.

PAYLOAD & TRAILERING WEIGHT RATINGS

MODEL	ENGINE	MAX PAYLOAD (LBS.) ¹	MAX CONVENTIONAL TRAILERING (LBS.) ²
REGULAR CAB			
Standard Bed 2WD	2.7L Turbo	2,260	9,100
Long Bed 2WD	2.7L Turbo	2,260	9,500
	5.3L V8	2,140	9,900
Standard Bed 4x4	2.7L Turbo	2,140	8,900
Long Bed 4x4	2.7L Turbo	2,120	9,300
	5.3L V8	2,000	9,600
DOUBLE CAB			
Standard Bed 2WD	2.7L Turbo	2,050	9,200
	5.3L V8	1,920	9,500
	Duramax 3.0L I-6	1,830	9,400
Standard Bed 2WD with Max Trailerling Package and 18" Wheels	5.3L V8	2,130	11,300
	Duramax 3.0L I-6	1,970	12,100
Standard Bed 2WD with Max Trailerling Package and 20" Wheels	Duramax 3.0L I-6	1,970	13,300
Standard Bed 4x4	2.7L Turbo	2,030	9,000
	5.3L V8	1,900	9,300
	6.2L V8	1,730	9,300
	Duramax 3.0L I-6	1,780	9,100
Standard Bed 4x4 with Max Trailerling Package and 18" Wheels	5.3L V8	2,110	11,100
	6.2L V8	1,900	12,000
	Duramax 3.0L I-6	1,960	11,800
Standard Bed 4x4 with Max Trailerling Package and 20" Wheels	6.2L V8	1,900	13,300
	Duramax 3.0L I-6	1,960	13,000

MODEL	ENGINE	MAX PAYLOAD (LBS.) ¹	MAX CONVENTIONAL TRAILERING (LBS.) ²
CREW CAB			
Short Bed 2WD	2.7L Turbo	2,030	9,200
	5.3L V8	2,010	9,500
	Duramax 3.0L I-6	1,920	9,300
Short Bed 2WD with Max Trailerling Package and 18" Wheels	5.3L V8	2,030	11,300
	Duramax 3.0L I-6	1,880	12,100
Short Bed 2WD with Max Trailerling Package and 20" Wheels	Duramax 3.0L I-6	1,880	13,300
Standard Bed 2WD	2.7L Turbo	1,960	9,200
	5.3L V8	1,930	9,500
Standard Bed 2WD with Max Trailerling Package and 18" Wheels	5.3L V8	1,960	11,200
Short Bed 4x4	2.7L Turbo	2,020	9,000
	5.3L V8	1,990	9,300
	6.2L V8	1,820	9,200
	Duramax 3.0L I-6	1,870	9,000
Short Bed 4x4 with Max Trailerling Package and 18" Wheels	5.3L V8	2,020	11,000
	6.2L V8	1,980	11,900
	Duramax 3.0L I-6	1,870	11,800
Short Bed 4x4 with Max Trailerling Package and 20" Wheels	6.2L V8	1,980	13,200
	Duramax 3.0L I-6	1,870	13,000
Short Bed ZR2 4x4	6.2L V8	1,520	8,800
	2.7L Turbo	1,960	9,000
	5.3L V8	1,940	9,200
	6.2L V8	1,760	9,100
Standard Bed 4x4	Duramax 3.0L I-6	1,810	9,000
	5.3L V8	1,970	11,000
	6.2L V8	1,920	11,900
Standard Bed 4x4 with Max Trailerling Package and 18" Wheels	Duramax 3.0L I-6	1,820	11,700
	6.2L V8	1,920	13,200
Standard Bed 4x4 with Max Trailerling Package and 20" Wheels	Duramax 3.0L I-6	1,820	12,900

Trailerling Guide >

¹ These maximum payload ratings are intended for comparison purposes only. Before you buy a vehicle or use it to haul people or cargo, carefully review the Vehicle Loading section of the Owner's Manual and check the carrying capacity of your specific vehicle on the label on the inside of the driver door jamb. ² Maximum trailerling ratings are intended for comparison purposes only. Before you buy a vehicle or use it for trailerling, carefully review the Trailerling section of the Owner's Manual. The trailerling capacity of your specific vehicle may vary. The weight of passengers, cargo and options or accessories may reduce the amount you can trailer.

WORK TRUCK (WT)



Summit White



Sterling Gray Metallic



Dark Ash Metallic



Red Hot



Glacier Blue Metallic¹



Northsky Blue Metallic



Black

¹Extra-cost color.

WORK TRUCK (WT)



Available on Regular Cab, Double Cab and Crew Cab. In addition to standard equipment, select WT features include:

MECHANICAL

Engine – 2.7L Turbo High-Output (L3B) with Automatic Stop/Start

Transmission – 8-speed automatic

EXTERIOR

Bumpers – semi-gloss Black, front and rear

Glass – solar-absorbing tinted

Headlamps – halogen reflector headlamps and daytime running lamps, automatic on/off with automatic delay

Mirrors – manual-adjustable with Black mirror caps (Double Cab and Crew Cab)
– heated, power-adjustable with Black mirror caps (Regular Cab)

Tailgate – manual lift, locking

INTERIOR

Air conditioning – single-zone

Entertainment – Chevrolet Infotainment 3 system¹ with 7-inch diagonal color touch-screen

Floor covering – rubberized-vinyl

Rear Vision Camera²

Seats – front 40/20/40 split-bench with covered armrest storage and lockable underseat storage; 4-way manual driver and front passenger seat adjusters; rear 60/40 split-folding bench (Double Cab and Crew Cab)

Steering column – manual tilt-wheel

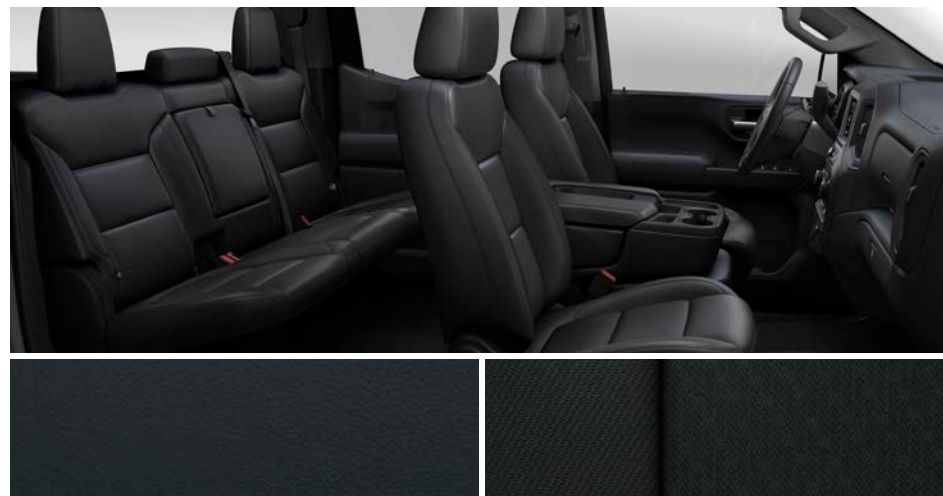

Jet Black Vinyl (shown)

Jet Black Cloth



17" Ultra Silver-Painted Steel Wheels (RD6)
Standard on WT



17" Bright Silver-Painted Aluminum Wheels (Q5U)
Available on WT



18" Bright Silver-Painted Aluminum Wheels (RCV)
Available on WT³

¹ Chevrolet Infotainment System functionality varies by model. Full functionality requires compatible Bluetooth and smartphone, and USB connectivity for some devices. ² Safety or driver assistance features are no substitute for the driver's responsibility to operate the vehicle in a safe manner. Read the vehicle Owner's Manual for important feature limitations and information. ³ Requires Double Cab or Crew Cab and available 5.3L V8 engine (L84), Z71 Off-Road Package and LT275/65R18 Goodyear Wrangler DuraTrac mud-terrain tires.

CUSTOM



Summit White



Sterling Gray Metallic



Dark Ash Metallic



Red Hot



Glacier Blue Metallic¹



Northsky Blue Metallic



Black

¹Extra-cost color.

CUSTOM



Available on Double Cab and Crew Cab. In addition to [standard equipment](#), select Custom features include:

MECHANICAL

Trailer Package – trailer hitch, 7-pin and 4-pin connectors; Hitch Guidance¹

Engine – 2.7L Turbo High-Output (L3B) with Automatic Stop/Start

Transmission – 8-speed automatic

EXTERIOR

Bumpers – body-color, front and rear

Glass – deep-tinted behind front doors

Mirrors – heated, power-adjustable with Black mirror caps

Recovery hooks² – Black

INTERIOR

Custom Convenience Package – remote vehicle starter system, unauthorized entry theft-deterrent system, rear-window defogger, EZ Lift power lock and release tailgate, and key fob-activated LED cargo area lighting

Air conditioning – single-zone

Cruise control – electronic with Set and Resume Speed, steering wheel-mounted controls

Entertainment – Chevrolet Infotainment 3 system³ with 7-inch diagonal color touch-screen

Floor covering – color-keyed carpeting

Floor mats – front and rear, vinyl

Seats – front 40/20/40 split-bench with covered armrest storage and lockable underseat storage; 10-way power driver seat adjuster with power lumbar control and 4-way manual front passenger seat adjuster; rear 60/40 split-folding bench

SiriusXM^{®4} – 3-month trial subscription to SXM Platinum Plan

Steering column – manual tilt-wheel

Wireless Apple CarPlay^{®5} and wireless Android Auto^{™6} compatibility

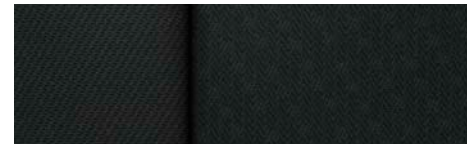
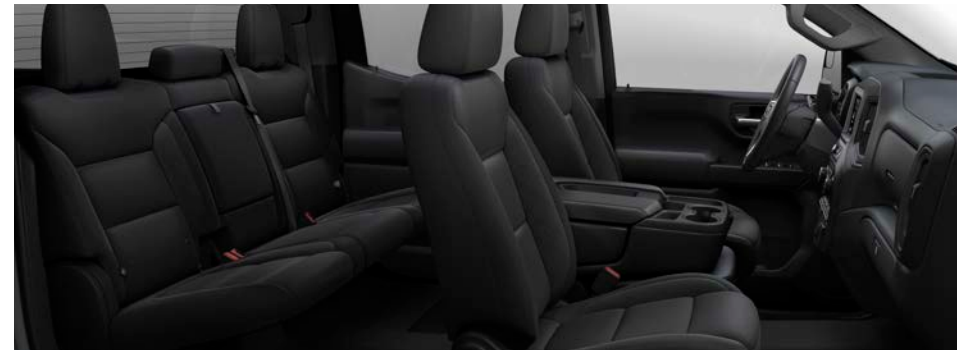

Jet Black Cloth



20" Bright Silver-Painted Aluminum Wheels (N2P)
Standard on Custom



20" High-Gloss Black-Painted Aluminum Wheels (RD5)
Available on Custom

¹ Safety or driver assistance features are no substitute for the driver's responsibility to operate the vehicle in a safe manner. Read the vehicle Owner's Manual for important feature limitations and information. ² To avoid the risk of injury, never use recovery hooks to tow a vehicle. For more information, see the Recovery Hooks section of your Owner's Manual. ³ Chevrolet Infotainment System functionality varies by model. Full functionality requires compatible Bluetooth and smartphone, and USB connectivity for some devices. ⁴ If you decide to continue service after your trial, your selected subscription plan will automatically renew thereafter. You will be charged at then-current rates. Fees and taxes apply. To cancel you must call SiriusXM at 1-866-635-2349. See SiriusXM Customer Agreement for complete terms at siriusxm.com. All fees and programming subject to change. ⁵ Vehicle user interface is a product of Apple and its terms and privacy statements apply. Requires compatible iPhone and data plan rates apply. ⁶ Vehicle user interface is a product of Google and its terms and privacy statements apply. To use Android Auto on your car display, you'll need an Android phone running Android 6 or higher, an active data plan, and the Android Auto app.

CUSTOM TRAIL BOSS



Summit White



Sterling Gray Metallic



Dark Ash Metallic



Sand Dune Metallic



Harvest Bronze Metallic



Red Hot



Glacier Blue Metallic¹



Northsky Blue Metallic



Black

¹Extra-cost color.

CUSTOM TRAIL BOSS



Available on Crew Cab. In addition to [standard equipment](#), select Custom Trail Boss features include:

MECHANICAL

Suspension Package – Z71 Off-Road Package, Off-Road suspension with 2-inch factory lift and monotube shocks, Hill Descent Control, skid plates, heavy-duty air filter and Z71 badge

Trailer Package – trailer hitch, 7-pin and 4-pin connectors; Hitch Guidance¹

Differential – automatic locking rear

Engine – 2.7L Turbo High-Output (L3B) with Automatic Stop/Start

Transfer case – 2-speed, electronic Autotrac with push-button control

Transmission – 8-speed automatic

EXTERIOR

Bumpers – high-gloss Black, front and rear

Hood – raised with styled Black insert

Recovery hooks² – Performance Red

Tires – LT275/65R18C Goodyear Wrangler DuraTrac[®] mud-terrain

INTERIOR

Custom Convenience Package – remote vehicle starter system, unauthorized entry theft-deterrent system, rear-window defogger, EZ Lift power lock and release tailgate, and key fob-activated LED cargo area lighting

Air conditioning – single-zone

Cruise control – electronic with Set and Resume Speed, steering wheel-mounted controls

Entertainment – Chevrolet Infotainment 3 system³ with 7-inch diagonal color touch-screen

Seats – front 40/20/40 split-bench with covered armrest storage and lockable underseat storage; 10-way power driver seat adjuster with power lumbar control and 4-way manual front passenger seat adjuster; rear 60/40 split-folding bench

SiriusXM^{®4} – 3-month trial subscription to SXM Platinum Plan

Wireless Apple CarPlay^{®5} and wireless Android Auto^{™6} compatibility

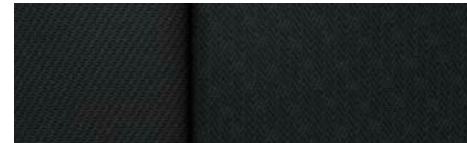
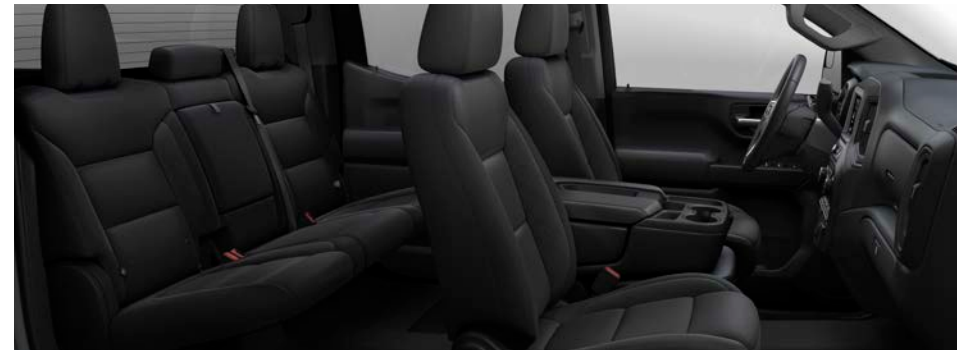

Jet Black Cloth



18" High-Gloss Black-Painted Aluminum Wheels (RD1)
Standard on Custom Trail Boss



20" High-Gloss Black-Painted Aluminum Wheels (RD5)
Available on Custom Trail Boss

¹ Safety or driver assistance features are no substitute for the driver's responsibility to operate the vehicle in a safe manner. Read the vehicle Owner's Manual for important feature limitations and information. ² To avoid the risk of injury, never use recovery hooks to tow a vehicle. For more information, see the Recovery Hooks section of your Owner's Manual. ³ Chevrolet Infotainment System functionality varies by model. Full functionality requires compatible Bluetooth and smartphone, and USB connectivity for some devices. ⁴ If you decide to continue service after your trial, your selected subscription plan will automatically renew thereafter. You will be charged at then-current rates. Fees and taxes apply. To cancel you must call SiriusXM at 1-866-635-2349. See SiriusXM Customer Agreement for complete terms at siriusxm.com. All fees and programming subject to change. ⁵ Vehicle user interface is a product of Apple and its terms and privacy statements apply. Requires compatible iPhone and data plan rates apply. ⁶ Vehicle user interface is a product of Google and its terms and privacy statements apply. To use Android Auto on your car display, you'll need an Android phone running Android 6 or higher, an active data plan, and the Android Auto app.

LT



Summit White



Sterling Gray Metallic



Dark Ash Metallic



Harvest Bronze Metallic



Red Hot



Radiant Red Tintcoat¹



Glacier Blue Metallic¹



Northsky Blue Metallic



Black

¹Extra-cost color.

LT



Available on Double Cab and Crew Cab. In addition to standard equipment, select LT features include:

MECHANICAL

Trailer Package – trailer hitch, 7-pin and 4-pin connectors; Hitch Guidance¹

Differential – automatic locking rear

Engine – 2.7L Turbo High-Output (L3B) with Automatic Stop/Start

Transmission – 8-speed automatic

EXTERIOR

Bumpers – chrome, front and rear

Headlamps – LED reflector headlamps with LED signature daytime running lamps and Amber tracer animation

INTERIOR

Convenience Package – dual-zone automatic climate control, 10-way power driver seat adjuster with power lumbar control, heated driver and front outboard passenger seats, heated and wrapped steering wheel with mounted audio, cruise and phone controls, manual tilt/telescoping steering column, two charge-only USB ports² in second row, rear-window defogger, Keyless Open and Start, remote vehicle starter system and unauthorized entry theft-deterrent system

Cruise control – electronic with Set and Resume Speed, steering wheel-mounted controls

Driver Information Center – enhanced, 12.3-inch diagonal reconfigurable multi-color digital display

Entertainment – Chevrolet Infotainment 3 Premium system³ with 13.4-inch diagonal color touch-screen and Google built-in⁴ compatibility

Seats – front 40/20/40 split-bench with covered armrest storage and lockable underseat storage; 4-way manual front passenger seat adjuster; rear 60/40 split-folding bench

SiriusXM[®] with 360L⁵ – 3-month trial subscription to SXM Platinum Plan

Wireless Apple CarPlay^{®6} and wireless Android Auto^{™7} compatibility

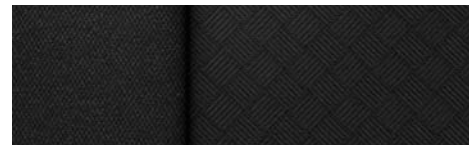
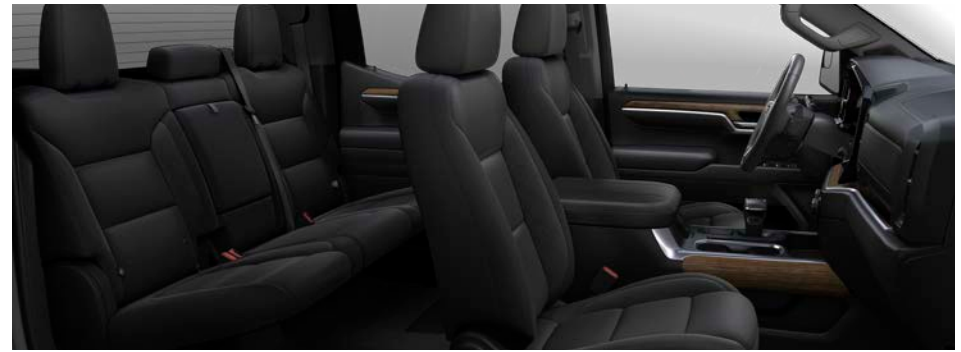

Jet Black Cloth (shown)

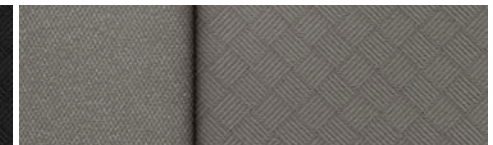

Gideon Cloth



Jet Black Leather-Appointed Front Seating⁸



Gideon Leather-Appointed Front Seating⁸



17" Bright Silver-Painted Aluminum
Wheels (Q5U)
Standard on LT



18" Bright Silver-Painted Aluminum
Wheels (RCV)
Available on LT



20" Machined-Face
Painted-Aluminum Wheels with
Grazen-Painted Pockets (NZN)
Available on LT

¹ Safety or driver assistance features are no substitute for the driver's responsibility to operate the vehicle in a safe manner. Read the vehicle Owner's Manual for important feature limitations and information. ² Not compatible with all devices. ³ Chevrolet Infotainment System functionality varies by model. Full functionality requires compatible Bluetooth and smartphone, and USB connectivity for some devices. ⁴ Google built-in services are subject to limitations and availability may vary by vehicle, infotainment system and location. Select service plan required. Certain Google actions and functionality may require account linking. User terms and privacy statements apply. ⁵ If you decide to continue service after your trial, your selected subscription plan will automatically renew thereafter. You will be charged at then-current rates. Fees and taxes apply. To cancel you must call SiriusXM at 1-866-635-2349. See SiriusXM Customer Agreement for complete terms at siriusxm.com. All fees and programming subject to change. Certain features require a SiriusXM subscription and the Chevrolet Connected Access plan. See siriusxm.com and onstar.com for details and limitations. ⁶ Vehicle user interface is a product of Apple and its terms and privacy statements apply. Requires compatible iPhone and data plan rates apply. ⁷ Vehicle user interface is a product of Google and its terms and privacy statements apply. To use Android Auto on your car display, you'll need an Android phone running Android 6 or higher, an active data plan, and the Android Auto app. ⁸ Requires available Leather Package and Convenience Package II.

RST



Summit White



Sterling Gray Metallic



Dark Ash Metallic



Red Hot



Radiant Red Tintcoat¹



Glacier Blue Metallic¹



Northsky Blue Metallic



Black

¹Extra-cost color.

RST



Available on Double Cab and Crew Cab. In addition to [standard equipment](#), select RST features include:

MECHANICAL

Trailer Package – trailer hitch, 7-pin and 4-pin connectors; Hitch Guidance¹

Differential – automatic locking rear

Engine – 2.7L Turbo High-Output (L3B) with Automatic Stop/Start (Double Cab); 5.3L EcoTec3 V8 (L84) with Automatic Stop/Start (Crew Cab)

Transmission – 8-speed automatic (Double Cab); 10-speed automatic (Crew Cab)

EXTERIOR

Bumpers – body-color, front and rear

Chevrolet bowtie emblems – Black

Fog lamps – LED

Headlamps – LED reflector headlamps with LED signature daytime running lamps and Amber tracer animation

INTERIOR

Convenience Package – dual-zone automatic climate control, 10-way power driver seat adjuster with power lumbar control, heated driver and front outboard passenger seats, heated and wrapped steering wheel with mounted audio, cruise and phone controls, manual tilt/telescoping steering column, two charge-only USB ports² in second row, rear-window defogger, Keyless Open and Start, remote vehicle starter system and unauthorized entry theft-deterrent system

Driver Information Center – enhanced, 12.3-inch diagonal reconfigurable multi-color digital display

Entertainment – Chevrolet Infotainment 3 Premium system³ with 13.4-inch diagonal color touch-screen and Google built-in⁴ compatibility

Seats – front 40/20/40 split-bench with covered armrest storage and lockable underseat storage; 4-way manual front passenger seat adjuster; rear 60/40 split-folding bench

Wireless Apple CarPlay⁵ and wireless Android Auto⁶ compatibility

¹ Safety or driver assistance features are no substitute for the driver's responsibility to operate the vehicle in a safe manner. Read the vehicle Owner's Manual for important feature limitations and information. ² Not compatible with all devices. ³ Chevrolet Infotainment System functionality varies by model. Full functionality requires compatible Bluetooth and smartphone, and USB connectivity for some devices. ⁴ Google built-in services are subject to limitations and availability may vary by vehicle, infotainment system and location. Select service plan required. Certain Google actions and functionality may require account linking. User terms and privacy statements apply. ⁵ Vehicle user interface is a product of Apple and its terms and privacy statements apply. Requires compatible iPhone and data plan rates apply. ⁶ Vehicle user interface is a product of Google and its terms and privacy statements apply. To use Android Auto on your car display, you'll need an Android phone running Android 6 or higher, an active data plan, and the Android Auto app. ⁷ Requires available Leather Package, Convenience Package II and front bucket seats with center console.

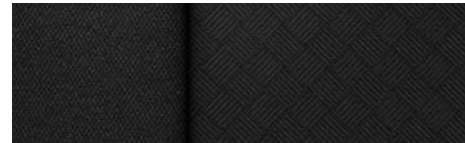

Jet Black Cloth

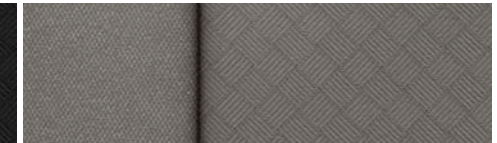

Gideon Cloth

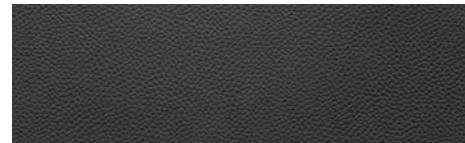

Jet Black Leather-Appointed Front Seating⁷

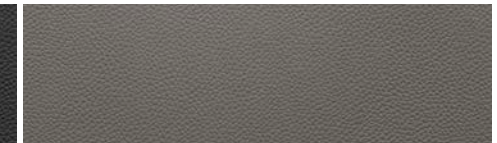

Gideon Leather-Appointed Front Seating⁷ (shown)



18" Bright Silver-Painted Aluminum Wheels (RCV)
Standard on RST



20" High-Gloss Black-Painted Aluminum Wheels (RD5)
Available on RST



20" Machined-Face Painted-Aluminum Wheels
with Grazen-Painted Pockets (NZN)
Available on RST



20" High-Gloss Black-Painted Aluminum Wheels
with Red Accents (RPS)
Available on RST with Redline Edition

LT TRAIL BOSS



Summit White



Iridescent Pearl Tricoat¹



Sterling Gray Metallic



Dark Ash Metallic



Sand Dune Metallic



Harvest Bronze Metallic



Red Hot



Radiant Red Tintcoat¹



Glacier Blue Metallic¹



Northsky Blue Metallic



Black

¹Extra-cost color.

LT TRAIL BOSS



Available on Crew Cab. In addition to [standard equipment](#), select LT Trail Boss features include:

MECHANICAL

Suspension Package – Z71 Off-Road Package, Off-Road suspension with 2-inch factory lift and monotube shocks, Hill Descent Control, skid plates, heavy-duty air filter and Z71 badge

Trailer Package – trailer hitch, 7-pin and 4-pin connectors; Hitch Guidance¹

Differential – automatic locking rear

Engine – 2.7L Turbo High-Output (L3B) with Automatic Stop/Start

Transfer case – 2-speed, electronic Autotrac with push-button control

Transmission – 8-speed automatic

EXTERIOR

Bumpers – high-gloss Black, front and rear

Chevrolet bowtie emblems – Black

Fog lamps – LED

Headlamps – LED reflector headlamps with LED signature daytime running lamps and Amber tracer animation

Hood – raised with styled Black insert

Recovery hooks² – Performance Red

Tires – LT275/65R18C Goodyear Wrangler DuraTrac[®] mud-terrain

INTERIOR

Convenience Package – dual-zone automatic climate control, 10-way power driver seat adjuster with power lumbar control, heated driver and front outboard passenger seats, heated and wrapped steering wheel with mounted audio, cruise and phone controls, manual tilt/telescoping steering column, two charge-only USB ports³ in second row, rear-window defogger, Keyless Open and Start, remote vehicle starter system and unauthorized entry theft-deterrent system

Driver Information Center – enhanced, 12.3-inch diagonal reconfigurable multi-color digital display

Entertainment – Chevrolet Infotainment 3 Premium system⁴ with 13.4-inch diagonal color touch-screen and Google built-in⁵ compatibility

Floor liners – all-weather, front and rear with Z71 logo

Seat – front 40/20/40 split-bench with covered armrest storage and lockable underseat storage; 4-way manual front passenger seat adjuster; rear 60/40 split-folding bench

Wireless Apple CarPlay^{®6} and wireless Android Auto^{™7} compatibility

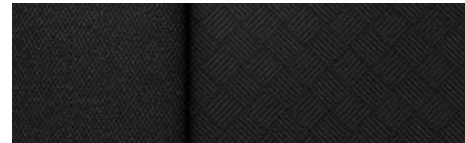
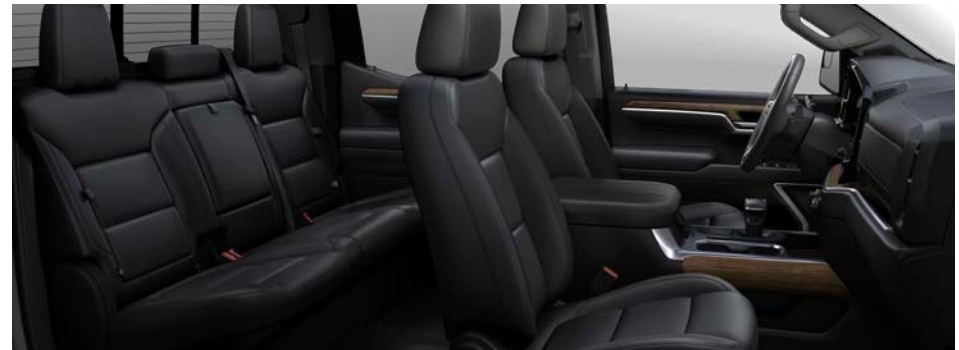

Jet Black Cloth

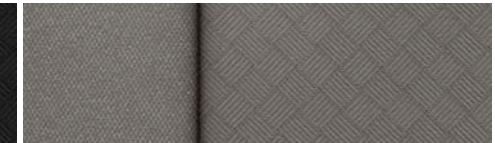

Gideon Cloth

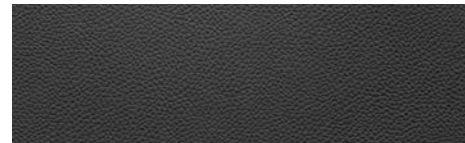

Jet Black Leather-Appointed Front Seating⁸ (shown)

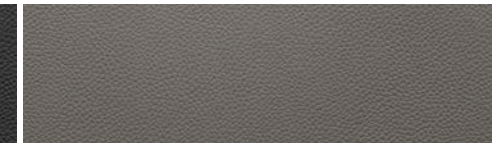

Gideon Leather-Appointed Front Seating⁸



18" High-Gloss Black-Painted Aluminum Wheels (RD1)
Standard on LT Trail Boss



20" High-Gloss Black-Painted Aluminum Wheels (RD5)
Available on LT Trail Boss

¹ Safety or driver assistance features are no substitute for the driver's responsibility to operate the vehicle in a safe manner. Read the vehicle Owner's Manual for important feature limitations and information. ² To avoid the risk of injury, never use recovery hooks to tow a vehicle. For more information, see the Recovery Hooks section of your Owner's Manual. ³ Not compatible with all devices. ⁴ Chevrolet Infotainment System functionality varies by model. Full functionality requires compatible Bluetooth and smartphone, and USB connectivity for some devices. ⁵ Google built-in services are subject to limitations and availability may vary by vehicle, infotainment system and location. Select service plan required. Certain Google actions and functionality may require account linking. User terms and privacy statements apply. ⁶ Vehicle user interface is a product of Apple and its terms and privacy statements apply. Requires compatible iPhone and data plan rates apply. ⁷ Vehicle user interface is a product of Google and its terms and privacy statements apply. To use Android Auto on your car display, you'll need an Android phone running Android 6 or higher, an active data plan, and the Android Auto app. ⁸ Requires available Leather Package, Convenience Package II and front bucket seats with center console.

LTZ



Summit White



Iridescent Pearl Tricoat¹



Sterling Gray Metallic



Dark Ash Metallic



Harvest Bronze Metallic



Radiant Red Tintcoat¹



Glacier Blue Metallic¹



Northsky Blue Metallic



Black

¹Extra-cost color.

LTZ



Available on Crew Cab. In addition to [standard equipment](#), select LTZ features include:

MECHANICAL

Trailer Package – trailer hitch, 7-pin and 4-pin connectors; Hitch Guidance with Hitch View;¹ Trailer App

Differential – automatic locking rear

Engine – 5.3L EcoTec3 V8 (L84) with Automatic Stop/Start

Trailer brake controller – integrated

Transmission – 10-speed automatic with Electronic Transmission Range Selector (ETRS)

EXTERIOR

Bumpers – chrome, front and rear

Fog lamps – LED

Headlamps – high-intensity LED reflector headlamps with LED signature curtain daytime running lamps and White tracer animation

Mirrors – heated, power-adjustable, power-folding with memory and driver-side auto-dimming features, puddle lamps, and perimeter lighting; chrome mirror caps

Tailgate – power-up/-down tailgate with power lock and release

INTERIOR

LTZ Convenience Package – front bucket seats with center console, power tilt/telescoping steering column, Bose premium 7-speaker sound system with Richbass woofer and two additional USB ports² and auxiliary input jack inside center console

Safety Package¹ – HD Surround Vision, Rear Cross Traffic Braking, Rear Pedestrian Alert, Trailer Camera Provisions, Trailer Side Blind Zone Alert and perimeter lighting

Air conditioning – automatic, dual-zone with individual climate settings for driver and front passenger

Driver Information Center – enhanced, 12.3-inch diagonal reconfigurable multi-color digital display

Entertainment – Chevrolet Infotainment 3 Premium system³ with 13.4-inch diagonal color touch-screen and Google built-in⁴ compatibility

Memory settings – recalls two presets for power driver seat and exterior mirrors

Safety Alert Seat¹

Seats – 10-way power front seat adjusters with power lumbar control; heated and ventilated front seats; rear 60/40 folding bench with seatback storage on left and right side, center foldout armrest with two cup holders, and underseat storage

Steering wheel – heated

Wireless Apple CarPlay⁵ and wireless Android Auto⁶ compatibility

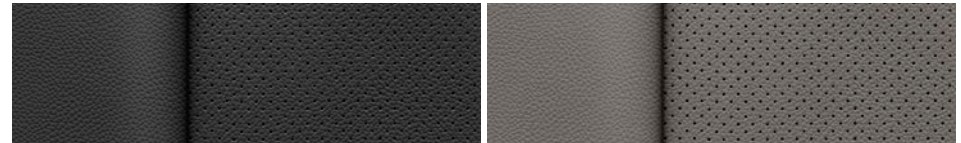
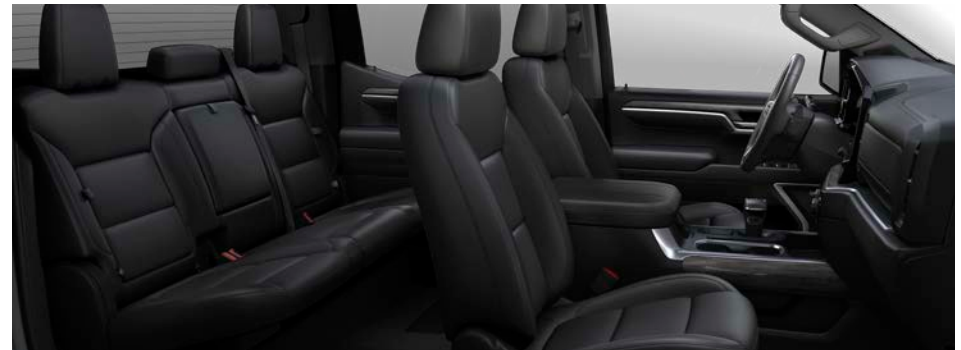

Jet Black Perforated Leather-Appointed Front Seating (shown) Gideon Perforated Leather-Appointed Front Seating



20" Sterling Silver-Painted Aluminum Wheels (RHO)
Standard on LTZ

¹ Safety or driver assistance features are no substitute for the driver's responsibility to operate the vehicle in a safe manner. Read the vehicle Owner's Manual for important feature limitations and information. ² Not compatible with all devices. ³ Chevrolet Infotainment System functionality varies by model. Full functionality requires compatible Bluetooth and smartphone, and USB connectivity for some devices. ⁴ Google built-in services are subject to limitations and availability may vary by vehicle, infotainment system and location. Select service plan required. Certain Google actions and functionality may require account linking. User terms and privacy statements apply. ⁵ Vehicle user interface is a product of Apple and its terms and privacy statements apply. Requires compatible iPhone and data plan rates apply. ⁶ Vehicle user interface is a product of Google and its terms and privacy statements apply. To use Android Auto on your car display, you'll need an Android phone running Android 6 or higher, an active data plan, and the Android Auto app.

ZR2



Summit White



Sterling Gray Metallic



Dark Ash Metallic



Sand Dune Metallic



Harvest Bronze Metallic



Red Hot



Glacier Blue Metallic¹



Northsky Blue Metallic



Black

¹Extra-cost color.

ZR2



Available on Crew Cab. In addition to standard equipment, select ZR2 features include:

MECHANICAL

Suspension Package – ZR2 High-Performance suspension with factory lift and Multimatic DSSV™ dampers

Trailer Package – trailer hitch, 7-pin and 4-pin connectors; Hitch Guidance with Hitch View;¹ Trailer App

Differentials – full locking front and rear, driver selectable

Engine – 6.2L EcoTec3 V8 (L87) with Automatic Stop/Start

Skid plates – large underbody aluminum

Transfer case – 2-speed, electronic Autotrac with push-button control; includes Terrain mode

Transmission – 10-speed automatic with Electronic Transmission Range Selector (ETRS)

EXTERIOR

Bedliner – Black Chevytec spray-on bedliner

Chevrolet bowtie emblems – Black and Chevy flowtie grille badge

Headlamps – high-intensity LED reflector headlamps with LED signature curtain daytime running lamps and White tracer animation; Black bezels

Hood – raised with styled Black insert

Recovery hooks² – Performance Red

Tires – LT275/70R18 Goodyear Wrangler Territory[®] mud-terrain

INTERIOR

Air conditioning – automatic, dual-zone with individual climate settings for driver and front passenger

Driver Information Center – enhanced, 12.3-inch diagonal reconfigurable multi-color digital display

Entertainment – Chevrolet Infotainment 3 Premium system³ with 13.4-inch diagonal color touch-screen and Google built-in⁴ compatibility

Safety and driver assistance features¹ – Bed View Camera, Rear Cross Traffic Braking, Rear Pedestrian Alert, HD Surround Vision, Safety Alert Seat, Trailer Camera Provisions and Trailer Side Blind Zone Alert

Seats – front bucket seats with center console, 10-way power front seats with power lumbar control; heated and ventilated front seats; heated rear outboard seating positions; rear 60/40 folding bench with seatback storage on left and right side, center foldout armrest with two cup holders, and underseat storage

Wireless Apple CarPlay^{®5} and wireless Android Auto^{™6} compatibility



Graystone Leather Seating Surfaces with Jet Black Accents and Strike Yellow Accent Stitching



18" Machined-Face Aluminum Wheels with Black-Painted Spokes and Oxide Gold-Painted Outer Ring Accents (RCW)
Standard on ZR2



18" Gloss Black-Painted Aluminum Wheels (RQL)
Available on ZR2

¹ Safety or driver assistance features are no substitute for the driver's responsibility to operate the vehicle in a safe manner. Read the vehicle Owner's Manual for important feature limitations and information. ² To avoid the risk of injury, never use recovery hooks to tow a vehicle. For more information, see the Recovery Hooks section of your Owner's Manual. ³ Chevrolet Infotainment System functionality varies by model. Full functionality requires compatible Bluetooth and smartphone, and USB connectivity for some devices. ⁴ Google built-in services are subject to limitations and availability may vary by vehicle, infotainment system and location. Select service plan required. Certain Google actions and functionality may require account linking. User terms and privacy statements apply. ⁵ Vehicle user interface is a product of Apple and its terms and privacy statements apply. Requires compatible iPhone and data plan rates apply. ⁶ Vehicle user interface is a product of Google and its terms and privacy statements apply. To use Android Auto on your car display, you'll need an Android phone running Android 6 or higher, an active data plan, and the Android Auto app.

HIGH COUNTRY



Iridescent Pearl Tricoat¹



Sterling Gray Metallic



Dark Ash Metallic



Harvest Bronze Metallic



Radiant Red Tintcoat¹



Northsky Blue Metallic



Black

¹Extra-cost color.

HIGH COUNTRY



Available on Crew Cab. In addition to [standard equipment](#), select High Country features include:

MECHANICAL

Trailer Package – trailer hitch, 7-pin and 4-pin connectors; Hitch Guidance with Hitch View;¹ Trailer App

Differential – automatic locking rear

Engine – 5.3L EcoTec3 V8 (L84) with Automatic Stop/Start

Exhaust – dual-outlet with polished rectangular tips

Trailer brake controller – integrated

Transmission – 10-speed automatic with Electronic Transmission Range Selector (ETRS)

EXTERIOR

Assist steps – chrome, wheel-to-wheel

Bedliner – Black Chevytec spray-on bedliner

Headlamps – high-intensity LED reflector headlamps with LED signature curtain daytime running lamps and White tracer animation

Recovery hooks² – chrome

Tailgate – power-up/-down tailgate with power lock and release

INTERIOR

Air conditioning – automatic, dual-zone with individual climate settings for driver and front passenger

Audio system – Bose premium 7-speaker sound system with stainless steel speaker grilles and Richbass woofer

Driver Information Center – enhanced, 12.3-inch diagonal reconfigurable multi-color digital display

Entertainment – Chevrolet Infotainment 3 Premium system³ with 13.4-inch diagonal color touch-screen and Google built-in⁴ compatibility

Memory settings – recalls two presets for power driver seat and exterior mirrors

Safety and driver assistance features¹ – Bed View Camera, Rear Cross Traffic Braking, Rear Pedestrian Alert, HD Surround Vision, Safety Alert Seat, Trailer Camera Provisions and Trailer Side Blind Zone Alert

Seats – front bucket seats with center console, 10-way power front seats with power lumbar control; heated and ventilated front seats; heated rear outboard seating positions; rear 60/40 folding bench with seatback storage on left and right side, center foldout armrest with two cup holders, and underseat storage

Steering column – power tilt/telescoping

Wireless Apple CarPlay⁵ and wireless Android Auto⁶ compatibility

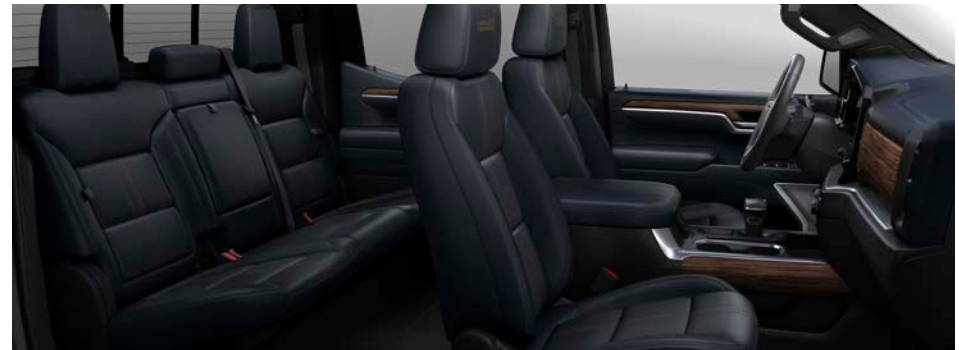

Jet Black Perforated Leather Seating Surfaces

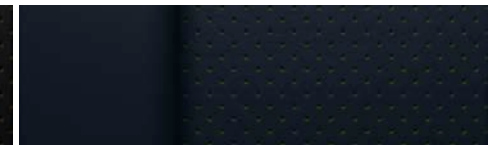

Nightshift Blue Perforated Leather Seating Surfaces with Jet Black Accents (shown)



Jet Black Perforated Leather Seating Surfaces with Umber Accents



20" Machined-Aluminum Wheels with Charcoal Pockets (NZV)
Standard on High Country



22" Painted-Aluminum Wheels with Chrome Inserts (RPT)
Available on High Country

¹ Safety or driver assistance features are no substitute for the driver's responsibility to operate the vehicle in a safe manner. Read the vehicle Owner's Manual for important feature limitations and information. ² To avoid the risk of injury, never use recovery hooks to tow a vehicle. For more information, see the Recovery Hooks section of your Owner's Manual. ³ Chevrolet Infotainment System functionality varies by model. Full functionality requires compatible Bluetooth and smartphone, and USB connectivity for some devices. ⁴ Google built-in services are subject to limitations and availability may vary by vehicle, infotainment system and location. Select service plan required. Certain Google actions and functionality may require account linking. User terms and privacy statements apply. ⁵ Vehicle user interface is a product of Apple and its terms and privacy statements apply. Requires compatible iPhone and data plan rates apply. ⁶ Vehicle user interface is a product of Google and its terms and privacy statements apply. To use Android Auto on your car display, you'll need an Android phone running Android 6 or higher, an active data plan, and the Android Auto app.

STANDARD EQUIPMENT

Standard on every Silverado 1500:

MECHANICAL

Battery – heavy-duty with rundown protection and retained accessory power

Brakes – 4-wheel antilock disc with Duralife® brake rotors and brake lining wear indicator

Frame – fully boxed frame with hydroformed front section

StabiliTrak – Electronic Stability Control System and Traction Control; includes Electronic Trailer Sway Control and Hill Start Assist

Steering – rack-and-pinion with Electric Power Steering (EPS) assist

Trailerling Information Label – provides maximum trailerling weight ratings for tongue weight and conventional, gooseneck and 5th-wheel trailerling

EXTERIOR

Bumper – rear CornerSteps

Cargo area lighting – integrated with center high-mounted stop lamp

Daytime running lamps – automatic on/off with automatic delay

Fuel filler – capless fueling

Pickup bed – Durabed

Tailgate and bed rail – protection cap

Tie-downs – 12 fixed cargo tie-downs, rated at 500 lbs¹ per corner

Tire – carrier lock

Tire – full-size spare

INTERIOR

Chevy Safety Assist²

Automatic Emergency Braking

Front Pedestrian Braking

Lane Keep Assist with Lane Departure Warning

Forward Collision Alert

IntelliBeam, auto high beams

Following Distance Indicator

Airbags³ – dual-stage frontal airbags for driver and front outboard passenger; seat-mounted side-impact airbags for driver and front outboard passenger; head-curtain airbags for front and rear outboard seating positions; includes front outboard Passenger Sensing System for frontal outboard passenger airbag

Air vents – rear, heating/cooling (Double Cab and Crew Cab)

Assist handles – driver and front passenger, A-pillar; rear passenger, B-pillar

Buckle to Drive

Connectivity – Bluetooth® phone connectivity and wireless audio streaming⁴

Door locks – power programmable with lockout protection and manual rear door child security

Driver Information Center

Media – two USB ports⁵ on instrument panel

Power outlet – 12-volt auxiliary, front

Push-Button Start

Rear Seat Reminder⁶ (Double Cab and Crew Cab)

Remote Keyless Entry

Teen Driver technology²

Temperature display – outside

Tire Pressure Monitoring System – with auto learn and Tire Fill Alert (does not apply to spare tire)

Windows – power with driver express-up/-down

¹ These maximum payload ratings are intended for comparison purposes only. Before you buy a vehicle or use it to haul people or cargo, carefully review the Vehicle Loading section of the Owner's Manual and check the carrying capacity of your specific vehicle on the label on the inside of the driver door jamb. ² Safety or driver assistance features are no substitute for the driver's responsibility to operate the vehicle in a safe manner. Read the vehicle Owner's Manual for important feature limitations and information.

³ A NOTE ON CHILD SAFETY: Always use seat belts and the correct child restraint for your child's age and size, even with airbags. Even in vehicles equipped with the Passenger Sensing System, children are safer when properly secured in a rear seat in the appropriate infant, child or booster seat. Never place a rear-facing infant restraint in the front seat of any vehicle equipped with an active frontal airbag. See your vehicle Owner's Manual and the child safety seat instructions for more safety information.

⁴ Go to my.chevrolet.com/learnAbout/bluetooth to find out which phones are compatible with the vehicle. Full Bluetooth feature functionality varies by device, model and software version. ⁵ Not compatible with all devices. ⁶ Does not detect people or items. Always check rear seat before exiting.

● STANDARD ○ AVAILABLE – NOT AVAILABLE

	WT	CUSTOM	CUSTOM TB	LT	RST	LT TB	LTZ	ZR2	HIGH COUNTRY
SAFETY AND DRIVER ASSISTANCE									
Chevy Safety Assist ¹	●	●	●	●	●	●	●	●	●
Automatic Emergency Braking									
Front Pedestrian Braking									
Lane Keep Assist with Lane Departure Warning									
Forward Collision Alert									
IntelliBeam, auto high beams									
Following Distance Indicator									
Airbags ² – dual-stage frontal airbags for driver and front outboard passenger; seat-mounted side-impact airbags for driver and front outboard passenger; head-curtain airbags for front and rear outboard seating positions; includes front outboard Passenger Sensing System for frontal outboard passenger airbag	●	●	●	●	●	●	●	●	●
Buckle to Drive	●	●	●	●	●	●	●	●	●
Enhanced Automatic Emergency Braking ¹ (replaces Automatic Emergency Braking; requires available Super Cruise ³)	–	–	–	–	–	–	–	–	○
Lane Change Alert with Side Blind Zone Alert ¹ (requires available WT Safety Package)	○	–	–	–	–	–	–	–	–
Rear Cross Traffic Braking ¹ (WT requires available WT Safety Package; LT, RST and LT Trail Boss require available Safety Package)	○	–	–	○	○	○	●	●	●

	WT	CUSTOM	CUSTOM TB	LT	RST	LT TB	LTZ	ZR2	HIGH COUNTRY
SAFETY AND DRIVER ASSISTANCE (CONTINUED)									
Rear Park Assist ¹ (WT requires available WT Safety Package; LT, RST and LT Trail Boss require available Safety Package)	○	–	–	○	○	○	–	●	–
Front and Rear Park Assist ¹	–	–	–	–	–	–	●	–	●
Rear Pedestrian Alert ¹ (WT requires available WT Safety Package; LT, RST and LT Trail Boss require available Safety Package)	○	–	–	○	○	○	●	●	●
Rear Vision Camera ¹	●	●	●	–	–	–	–	–	–
HD Rear Vision Camera ¹	–	–	–	●	●	●	–	–	–
HD Surround Vision ¹ (LT, RST and LT Trail Boss require available Safety Package)	–	–	–	○	○	○	●	●	●
Safety Alert Seat ¹	–	–	–	–	–	–	●	●	●
Teen Driver technology ¹	●	●	●	●	●	●	●	●	●
Theft-deterrent system – unauthorized entry	–	●	●	●	●	●	●	●	●
Tire Pressure Monitoring System – with auto learn and Tire Fill Alert (does not apply to spare tire)	●	●	●	●	●	●	●	●	●
Trailer Side Blind Zone Alert ¹ (LT, RST and LT Trail Boss require available Safety Package)	–	–	–	○	○	○	●	●	●
Up to 3 months of OnStar [®] Safety & Security coverage ⁴ (WT requires available SiriusXM ^{®5})	○	●	●	●	●	●	●	●	●

¹ Safety or driver assistance features are no substitute for the driver's responsibility to operate the vehicle in a safe manner. Read the vehicle Owner's Manual for important feature limitations and information. ² A NOTE ON CHILD SAFETY: Always use seat belts and the correct child restraint for your child's age and size, even with airbags. Even in vehicles equipped with the Passenger Sensing System, children are safer when properly secured in a rear seat in the appropriate infant, child or booster seat. Never place a rear-facing infant restraint in the front seat of any vehicle equipped with an active frontal airbag. See your vehicle Owner's Manual and the child safety seat instructions for more safety information. ³ Always pay attention while driving and when using Super Cruise. Do not use a hand-held device. Requires active Super Cruise plan or trial. Terms apply. Visit [chevrolet.com/supercruise.com](http://chevrolet.com/supercruise) for compatible roads and full details. ⁴ When you select a monthly plan within 15 days of activating your 1-month trial, you'll receive the next 2 months of the plan you select at no additional charge when you associate an approved payment method on file to your account and authorize recurring payments for your service plan. The amount and frequency of each recurring payment is based upon the service(s) and payment interval(s) you select from the options provided. After the trial expires, OnStar will automatically bill your payment method monthly at then-current standard monthly rates. Plans containing 4G LTE data will be billed every 30 days by AT&T. You may cancel at any time by pushing your blue OnStar button or calling 1-888-466-7827. May not be combined with other offers or retroactively applied. Offer subject to change. ⁵ If you decide to continue service after your trial, your selected subscription plan will automatically renew thereafter. You will be charged at then-current rates. Fees and taxes apply. To cancel you must call SiriusXM at 1-866-635-2349. See SiriusXM Customer Agreement for complete terms at siriusxm.com. All fees and programming subject to change.

● STANDARD ○ AVAILABLE – NOT AVAILABLE

	WT	CUSTOM	CUSTOM TB	LT	RST	LT TB	LTZ	ZR2	HIGH COUNTRY
EXTERIOR (CONTINUED)									
Grille – Chevrolet lettered grille, Black front grille bar and Black grille inserts with small Gold bowtie emblem	●	●	–	–	–	–	–	–	–
– Chevrolet lettered grille, Black front grille bar and Black grille inserts with small Z71 badge	–	–	●	–	–	–	–	–	–
– chrome front grille bar with Gold bowtie emblem and high-gloss Black grille inserts	–	–	–	●	–	–	–	–	–
– body-color front grille bar with Black bowtie emblem and high-gloss Black grille inserts	–	–	–	–	●	–	–	–	–
– high-gloss Black front grille bar with Black bowtie emblem and high-gloss Black grille inserts with small Z71 badge	–	–	–	–	–	●	–	–	–
– chrome front grille bar with Gold bowtie emblem and chrome grille inserts	–	–	–	–	–	–	●	–	–
– high-gloss Black front grille bar with Chevy flowtie emblem and high-gloss Black grille inserts with small ZR2 badge	–	–	–	–	–	–	–	●	–
– Galvano grille with Black accents and Gold bowtie emblem	–	–	–	–	–	–	–	–	●
Headlamps – halogen reflector	●	●	●	–	–	–	–	–	–
– LED reflector headlamps with LED signature daytime running lamps and Amber tracer animation	–	–	–	●	●	●	–	–	–
– high-intensity LED reflector headlamps with LED signature curtain daytime running lamps and White tracer animation (ZR2 includes Black bezels)	–	–	–	–	–	–	●	●	●
Lighting – perimeter (WT requires available WT Safety Package; LT, RST and LT Trail Boss require available Safety Package)	○	–	–	○	○	○	●	●	●
Mirrors – manual-adjustable (Double Cab and Crew Cab)	●	–	–	–	–	–	–	–	–
– heated, power-adjustable (standard on Regular Cab; Double Cab and Crew Cab WT require available WT Convenience Package)	○	●	●	●	●	●	–	–	–
– heated, power-adjustable, power-folding with memory and driver-side auto-dimming features, puddle lamps, and perimeter lighting	–	–	–	–	–	–	●	●	●
– vertical trailerling, heated upper glass, power-adjustable, manual-folding and manual-extending with lower convex mirrors and integrated turn signal indicators, clearance lamps and auxiliary lighting; includes interior auto-dimming mirror (WT requires available WT Convenience Package or WT Value Package and Trailerling Package)	○	–	–	○	○	○	–	–	–
– vertical trailerling, heated upper glass, power-adjustable, power-folding and manual-extending with lower convex mirrors and integrated turn signal indicators, puddle lamps, perimeter lighting, auxiliary lighting and memory; ZR2 and High Country include chrome mirror caps	–	–	–	–	–	–	○	○	○

	WT	CUSTOM	CUSTOM TB	LT	RST	LT TB	LTZ	ZR2	HIGH COUNTRY
EXTERIOR (CONTINUED)									
Mirror caps – Black	●	●	●	–	–	–	–	–	–
– high-gloss Black (WT requires available WT Safety Package)	○	–	–	–	●	●	–	●	–
– chrome (ZR2 and High Country require available vertical trailerling mirrors)	–	–	–	●	–	–	–	○	○
– body-color	–	–	–	–	–	–	–	–	●
Moldings – Black window beltline	●	●	●	●	●	●	–	●	–
– stainless steel window beltline	–	–	–	–	–	–	●	–	●
Pickup bed – Durabed	●	●	●	●	●	●	●	●	●
Power outlet – 120-volt (up to 400 watts, shared with instrument panel 120-volt outlet), bed-mounted (120-volt outlets will not function on certain Custom, Custom Trail Boss, LT, RST and LT Trail Boss models without dealer retrofit; see dealer or window label for details) (WT requires available EZ Lift power lock and release tailgate)	○	○	○	○	○	○	●	●	●
Recovery hooks ¹ – Black; included on WT and LT 4x4 models (WT 2WD models require available WT Safety Package; LT 2WD models require available Safety Package; Custom Trail Boss requires available Realtree [®] Special Edition or Midnight Edition; LT Trail Boss requires available Midnight Edition)	○	●	○	○	●	○	●	–	–
– Performance Red (RST requires available Redline Edition)	–	–	●	–	○	●	–	●	–
– chrome	–	–	–	–	–	–	–	–	●
Tailgate – manual lift	●	–	–	–	–	–	–	–	–
– EZ Lift, power lock and release (LTZ and High Country require available Multi-Flex Tailgate)	○	●	●	●	●	●	○	●	○
– power-up/-down tailgate function, power lock and release	–	–	–	○	○	○	●	○	●
– Multi-Flex, with six functional load/access features (WT, LTZ and High Country require available EZ Lift power lock and release tailgate; Custom not available with Rally Edition; LT, LT Trail Boss, LTZ, ZR2 and High Country not available with power-up/-down tailgate; RST not available with Rally Edition or power-up/-down tailgate)	○	○	○	○	○	○	○	○	○

¹ To avoid the risk of injury, never use recovery hooks to tow a vehicle. For more information, see the Recovery Hooks section of your Owner's Manual.

● STANDARD ○ AVAILABLE – NOT AVAILABLE

	WT	CUSTOM	CUSTOM TB	LT	RST	LT TB	LTZ	ZR2	HIGH COUNTRY
EXTERIOR (CONTINUED)									
Tailgate and bed rail – protection cap	●	●	●	●	●	●	●	●	●
Taillamps – incandescent	●	●	●	●	-	-	-	-	-
- LED	-	-	-	-	●	●	●	●	●
Tie-downs – 12 fixed cargo tie-downs, rated at 500 lbs ¹ per corner	●	●	●	●	●	●	●	●	●
Tire – carrier lock	●	●	●	●	●	●	●	●	●
- full-size spare	●	●	●	●	●	●	●	●	●
Tires – 255/70R17 all-season	●	-	-	●	-	-	-	-	-
- 265/70R17 all-terrain	○	-	-	○	-	-	-	-	-
- LT265/70R17 all-terrain	○	-	-	○	-	-	-	-	-
- 265/65R18 all-season (LT requires available 18" Bright Silver-painted aluminum wheels [RCV])	-	-	-	○	●	-	-	-	-
- 265/65R18 all-terrain (LT requires available 18" Bright Silver-painted aluminum wheels [RCV])	-	-	-	○	○	-	-	-	-
- 265/65R18 all-terrain, white outlined letter (LT requires available 18" Bright Silver-painted aluminum wheels [RCV])	-	-	-	○	○	-	-	-	-
- LT275/65R18 Goodyear Wrangler DuraTrac [®] mud-terrain (WT requires Double Cab or Crew Cab and available 5.3L V8 [L84] engine, Z71 Off-Road Package and 18" Bright Silver-painted aluminum wheels [RCV])	○	-	●	-	-	●	-	-	-
- LT275/70R18 Goodyear Wrangler Territory [®] mud-terrain	-	-	-	-	-	-	-	●	-
- 275/60R20 all-season (LT and RST require available 20" aluminum wheels; High Country requires 2WD)	-	●	-	○	○	-	●	-	●
- 275/60R20 all-terrain; included on High Country 4x4 (Custom Trail Boss, LT, RST and LT Trail Boss require available 20" aluminum wheels)	-	○	○	○	○	○	○	-	○
- LT265/60R20 Goodyear Wrangler Territory mud-terrain (requires available 20" aluminum wheels)	-	-	○	-	-	○	-	-	-
- 275/50R22 all-season (LT, RST and LTZ require 22" wheels from Chevrolet Accessories ² ; High Country requires available 22" painted-aluminum wheels with chrome inserts [RPT] or 22" wheels from Chevrolet Accessories ²)	-	-	-	○	○	-	○	-	○

	WT	CUSTOM	CUSTOM TB	LT	RST	LT TB	LTZ	ZR2	HIGH COUNTRY
EXTERIOR (CONTINUED)									
Wheelhouse liners – rear (WT not available on Regular Cab or 2WD Double Cab or Crew Cab models; LT, RST and LT Trail Boss require available Protection Package)	○	○	○	○	○	○	●	●	●
Wheels – 17" Ultra Silver-painted steel (RD6)	●	-	-	-	-	-	-	-	-
- 17" Bright Silver-painted aluminum (Q5U)	○	-	-	●	-	-	-	-	-
- 18" Bright Silver-painted aluminum (RCV) (WT requires Double Cab or Crew Cab and 5.3L V8 [L84], Z71 Off-Road Package and LT275/65R18 Goodyear Wrangler DuraTrac mud-terrain tires)	○	-	-	○	●	-	-	-	-
- 18" high-gloss Black-painted aluminum (RD1)	-	-	●	-	-	●	-	-	-
- 18" machined-face aluminum with Black-painted spokes and Oxide Gold-painted outer ring accents (RCW)	-	-	-	-	-	-	-	●	-
- 18" gloss Black-painted aluminum (RQL)	-	-	-	-	-	-	-	○	-
- 20" Bright Silver-painted aluminum (NZP)	-	●	-	-	-	-	-	-	-
- 20" high-gloss Black-painted aluminum (RD5)	-	○	○	-	○	○	-	-	-
- 20" machined-face painted-aluminum with Grazen-painted pockets (NZN)	-	-	-	○	○	-	-	-	-
- 20" high-gloss Black-painted aluminum with Red accents (RPS) (requires available Redline Edition)	-	-	-	-	○	-	-	-	-
- 20" Sterling Silver-painted aluminum (RH0)	-	-	-	-	-	-	●	-	-
- 20" machined-aluminum with Charcoal pockets (NZV)	-	-	-	-	-	-	-	-	●
- 22" painted-aluminum with chrome inserts (RPT) (requires available Adaptive Ride Control suspension and 275/50R22 all-season tires)	-	-	-	-	-	-	-	-	○
Wipers – front variable-speed, intermittent	●	●	●	●	●	●	-	-	-
- front variable-speed, intermittent with Rainsense [™]	-	-	-	-	-	-	●	●	●

¹ These maximum payload ratings are intended for comparison purposes only. Before you buy a vehicle or use it to haul people or cargo, carefully review the Vehicle Loading section of the Owner's Manual and check the carrying capacity of your specific vehicle on the label on the inside of the driver door jamb. ² Chevrolet Accessories are dealer-installed and covered by the GM 3-year/36,000-mile (whichever comes first) New Vehicle Limited Warranty when ordered with your new Silverado. See your dealer for details.

● STANDARD ○ AVAILABLE – NOT AVAILABLE

	WT	CUSTOM	CUSTOM TB	LT	RST	LT TB	LTZ	ZR2	HIGH COUNTRY
INTERIOR									
Air conditioning – single-zone, manual – automatic, dual-zone with individual climate settings for driver and front passenger	●	●	●	–	–	–	–	–	–
Air vents – rear, heating/cooling (Double Cab and Crew Cab)	●	●	●	●	●	●	●	●	●
Assist handles – driver and front passenger, A-pillar; rear passenger, B-pillar	●	●	●	●	●	●	●	●	●
Bed View Camera ¹ – includes two trailer view camera provisions (LT, RST and LT Trail Boss require available Convenience Package II and Safety Package; LTZ requires available Technology Package)	–	–	–	○	○	○	○	●	●
Center console – floor-mounted, with cup holders, cell phone storage, power cord management and hanging file holder capability (LT, RST and LT Trail Boss require available front bucket seats)	–	–	–	○	○	○	●	●	●
Compass – display in instrument cluster (WT requires available OnStar ^{®2})	○	●	●	●	●	●	●	●	●
Cruise control – electronic with Set and Resume Speed, steering wheel-mounted	○	●	●	●	●	●	●	●	●
Adaptive Cruise Control ¹ (LT, RST and LT Trail Boss require available Convenience Package II; LTZ requires available LTZ Convenience Package II; ZR2 and High Country require available Technology Package)	○	–	–	○	○	○	○	○	○
Super Cruise ³ – hands-free driver assistance technology with Automatic Lane Change and trailering capability (requires Crew Cab Short Bed, available Technology Package, and 6.2L V8 [L87] or Duramax 3.0L Turbo-Diesel I-6 [LZ0])	–	–	–	–	–	–	–	–	○
Defogger – rear-window	○	●	●	●	●	●	●	●	●
Door locks – power programmable with lockout protection and manual rear door child security	●	●	●	●	●	●	●	●	●
Driver Information Center – 3.5-inch diagonal monochromatic display – enhanced, 12.3-inch diagonal multi-color reconfigurable digital display, includes speedometer and tachometer	●	●	●	–	–	–	–	–	–
Floor covering – rubberized-vinyl – color-keyed carpeting	●	–	–	○	–	–	–	–	–

	WT	CUSTOM	CUSTOM TB	LT	RST	LT TB	LTZ	ZR2	HIGH COUNTRY
INTERIOR (CONTINUED)									
Floor liners – all-weather, front and rear; includes Z71 logo on front liners – all-weather, front and rear; includes Chevrolet logo on front liners – front and rear, with removable carpet inserts (Custom Trail Boss requires available Midnight Edition; LT, RST and LTZ require available Chevytec spray-on bedliner; LT Trail Boss requires available Protection Package)	–	–	–	–	–	●	–	–	–
Floor mats – front and rear, vinyl (WT requires available color-keyed carpeting) – front and rear, carpeted	○	●	●	●	●	–	●	–	–
Head-Up Display – 15-inch diagonal multi-color (requires available Technology Package)	–	–	–	–	–	–	○	○	○
Instrument cluster – 6-gauge with speedometer, fuel level, engine temperature, tachometer, voltage and oil pressure	●	●	●	–	–	–	–	–	–
Keyless Open and Start	–	–	–	●	●	●	●	●	●
Memory settings – recalls two presets for power driver seat and exterior mirrors	–	–	–	–	–	–	●	●	●
Mirror – rearview, manual day/night – rearview, auto-dimming (WT, LT, RST and LT Trail Boss require available vertical trailering mirrors) – Rear Camera Mirror ¹ (requires available Technology Package)	●	●	●	●	●	●	–	–	–
Power outlets – front auxiliary, 12-volt – 120-volt (up to 400 watts, shared with bed-mounted 120-volt outlet), on instrument panel (120-volt outlets will not function on certain Custom, Custom Trail Boss, LT, RST and LT Trail Boss models without dealer retrofit; see dealer or window label for details); WT includes two rear charge-only USB ports ⁴ (WT requires available EZ Lift power lock and release tailgate; USB ports will not function on certain WT, Custom and Custom Trail Boss models without dealer retrofit; see dealer or window label for details)	●	●	●	–	–	–	–	–	–
Push-Button Start	●	●	●	●	●	●	●	●	●
Rear Seat Reminder ⁵ (Double Cab and Crew Cab)	●	●	●	●	●	●	●	●	●
Remote Keyless Entry	●	●	●	●	●	●	●	●	●
Remote vehicle starter system	–	●	●	●	●	●	●	●	●

¹ Safety or driver assistance features are no substitute for the driver's responsibility to operate the vehicle in a safe manner. Read the vehicle Owner's Manual for important feature limitations and information. ² When you select a monthly plan within 15 days of activating your 1-month trial, you'll receive the next 2 months of the plan you select at no additional charge when you associate an approved payment method on file to your account and authorize recurring payments for your service plan. The amount and frequency of each recurring payment is based upon the service(s) and payment interval(s) you select from the options provided. After the trial expires, OnStar will automatically bill your payment method monthly at then-current standard monthly rates. Plans containing 4G LTE data will be billed every 30 days by AT&T. You may cancel at any time by pushing your blue OnStar button or calling 1-888-466-7827. May not be combined with other offers or retroactively applied. Offer subject to change. ³ Automatic Lane Change and Lane Change on Demand are not available while trailering. Always pay attention while driving and when using Super Cruise. Do not use a hand-held device. Requires active Super Cruise plan or trial. Terms apply. Visit chevroletssuperdrive.com for compatible roads and full details. ⁴ Not compatible with all devices. ⁵ Does not detect people or items. Always check rear seat before exiting.

● STANDARD ○ AVAILABLE – NOT AVAILABLE

	WT	CUSTOM	CUSTOM TB	LT	RST	LT TB	LTZ	ZR2	HIGH COUNTRY
INTERIOR (CONTINUED)									
Steering column – manual tilt-wheel	●	●	●	–	–	–	–	–	–
– manual tilt/telescoping	–	–	–	●	●	●	–	●	–
– power tilt/telescoping (ZR2 requires available Technology Package)	–	–	–	–	–	–	●	○	●
Steering wheel – mounted audio, cruise and phone controls	–	–	–	●	●	●	●	●	●
– wrapped	–	–	–	●	●	●	●	●	●
– heated	–	–	–	●	●	●	●	●	●
Sunroof – power (Crew Cab) (RST and LT Trail Boss require available Convenience Package II)	–	–	–	–	○	○	○	○	○
Temperature display – outside	●	●	●	●	●	●	●	●	●
Trailerling Camera Provisions ¹ (LT, RST and LT Trail Boss require available Safety Package)	–	–	–	○	○	○	●	●	●
Universal Home Remote – programmable, includes garage door opener (LT, RST and LT Trail Boss require available Convenience Package II; LTZ requires available LTZ Convenience Package II)	–	–	–	○	○	○	○	●	●
Windows – power with driver express-up/-down, all others express-down	●	●	●	●	●	●	–	–	–
– power with driver and front passenger express-up/-down, rear express-down	–	–	–	–	–	–	●	●	●
– power-sliding rear with defogger (LT, RST and LT Trail Boss require available Convenience Package II; LTZ requires available LTZ Convenience Package II)	–	–	–	○	○	○	○	●	●

	WT	CUSTOM	CUSTOM TB	LT	RST	LT TB	LTZ	ZR2	HIGH COUNTRY
SEATING									
Seats – front 40/20/40 split-bench with covered storage armrest and lockable underseat storage	●	●	●	●	●	●	–	–	–
– front bucket seats with center console (LT requires available 5.3L V8 [L84] or Duramax 3.0L Turbo-Diesel I-6 [LZ0]; RST and LT Trail Boss require available 5.3L V8 [L84], 6.2L V8 [L87] or Duramax 3.0L Turbo-Diesel I-6 [LZ0])	–	–	–	○	○	○	●	●	●
– rear 60/40 folding bench (Double Cab and Crew Cab on WT)	●	●	●	●	●	●	–	–	–
– rear 60/40 folding bench with seatback storage on left and right side and center foldout armrest with two cup holders (requires available Cloth Rear Seat with Storage Package) (Crew Cab)	–	○	○	○	○	○	–	–	–
– rear 60/40 folding bench with seatback storage on left and right side, center foldout armrest with two cup holders and full cab width underseat storage (LT, RST and LT Trail Boss require available Uplevel Rear Seat with Storage Package) (Crew Cab)	–	–	–	○	○	○	●	●	●
Seat – driver 4-way manual adjuster	●	–	–	–	–	–	–	–	–
– front passenger 4-way manual adjuster	●	–	●	●	●	●	–	–	–
– driver 10-way power adjuster with power lumbar control	–	●	●	●	●	●	●	●	●
– front passenger 10-way power adjuster with power lumbar control	–	–	–	–	–	–	●	●	●
Heated seats – driver and front outboard passenger	–	–	–	●	●	●	–	–	–
Heated and ventilated seats – driver and front passenger	–	–	–	–	–	–	●	●	●
Heated rear outboard seating positions (LTZ requires available LTZ Convenience Package II)	–	–	–	–	–	–	○	●	●

¹ Safety or driver assistance features are no substitute for the driver's responsibility to operate the vehicle in a safe manner. Read the vehicle Owner's Manual for important feature limitations and information.

● STANDARD ○ AVAILABLE – NOT AVAILABLE

	WT	CUSTOM	CUSTOM TB	LT	RST	LT TB	LTZ	ZR2	HIGH COUNTRY
ENTERTAINMENT									
Audio – 2-speaker system (Regular Cab)	●	–	–	–	–	–	–	–	–
– 6-speaker system (Double Cab and Crew Cab)	●	●	●	●	●	●	–	–	–
– 7-speaker Bose premium audio system with Richbass subwoofer; High Country includes stainless steel speaker grilles (RST and LT Trail Boss require available Convenience Package II)	–	–	–	–	○	○	●	●	●
Chevrolet Infotainment 3 system ¹ with 7-inch diagonal color touch-screen, AM/FM stereo, Bluetooth [®] audio streaming ² for two active devices, voice command pass-through to compatible phone, and Apple CarPlay ^{®3} and Android Auto ^{™4} compatibility	●	●	●	–	–	–	–	–	–
Chevrolet Infotainment 3 Premium system ¹ with 13.4-inch diagonal HD color touch-screen and Google built-in ⁵ compatibility, AM/FM stereo, Bluetooth audio streaming ² for two active devices, advanced voice recognition and available In-Vehicle Apps ⁶	–	–	–	●	●	●	●	●	●
SiriusXM ^{®7} – 3-month trial subscription to SXM Platinum Plan (WT requires available OnStar ^{®8})	○	●	●	–	–	–	–	–	–
SiriusXM with 360L ^{7,9} – 3-month trial subscription to SXM Platinum Plan	–	–	–	●	●	●	●	●	●

	WT	CUSTOM	CUSTOM TB	LT	RST	LT TB	LTZ	ZR2	HIGH COUNTRY
ENTERTAINMENT (CONTINUED)									
USB ports ¹⁰ – two on instrument panel	●	●	●	●	●	●	●	●	●
– two inside center console (LT, RST and LT Trail Boss require available front bucket seats with center console)	–	–	–	○	○	○	●	●	●
– two, charge-only, rear (WT requires available 120-volt power outlets; feature will not function on certain WT, Custom and Custom Trail Boss models without dealer retrofit; see dealer or window label for details)	○	○	○	●	●	●	●	●	●
Available Wi-Fi [®] Hotspot ¹¹ for up to seven devices, includes 1-month Unlimited Data Plan (WT requires available OnStar ^{®9})	○	○	○	○	○	○	○	○	○
Chevrolet Connected Access ¹² with up to 10 years of standard connectivity, which currently enables features such as Vehicle Diagnostics and Dealer Maintenance Notification (WT requires available OnStar ^{®9})	○	●	●	●	●	●	●	●	●
Wireless Apple CarPlay ³ and wireless Android Auto ⁴ compatibility (WT requires available OnStar ^{®9})	○	●	●	●	●	●	●	●	●
Wireless charging ¹³ (LT, RST and LT Trail Boss require available front bucket seats with center console; feature will not function on certain models; see dealer for details or the window label for features on a specific vehicle)	–	–	–	○	○	○	○	○	○

¹ Chevrolet Infotainment System functionality varies by model. Full functionality requires compatible Bluetooth and smartphone, and USB connectivity for some devices. ² Go to my.chevrolet.com/learnAbout/bluetooth to find out which phones are compatible with the vehicle. Full Bluetooth feature functionality varies by device, model and software version. ³ Vehicle user interface is a product of Apple and its terms and privacy statements apply. Requires compatible iPhone and data plan rates apply. ⁴ Vehicle user interface is a product of Google and its terms and privacy statements apply. To use Android Auto on your car display, you'll need an Android phone running Android 6 or higher, an active data plan, and the Android Auto app. ⁵ Google built-in services are subject to limitations and availability may vary by vehicle, infotainment system and location. Select service plan required. Certain Google actions and functionality may require account linking. User terms and privacy statements apply. ⁶ Third-party trademarks are the property of their respective third-party owners and used under agreement. Requires active service plan and paid AT&T vehicle data plan. Visit onstar.com for details and limitations. ⁷ If you decide to continue service after your trial, your selected subscription plan will automatically renew thereafter. You will be charged at then-current rates. Fees and taxes apply. To cancel you must call SiriusXM at 1-866-635-2349. See SiriusXM Customer Agreement for complete terms at siriusxm.com. All fees and programming subject to change. ⁸ When you select a monthly plan within 15 days of activating your 1-month trial, you'll receive the next 2 months of the plan you select at no additional charge when you associate an approved payment method on file to your account and authorize recurring payments for your service plan. The amount and frequency of each recurring payment is based upon the service(s) and payment interval(s) you select from the options provided. After the trial expires, OnStar will automatically bill your payment method monthly at then-current standard monthly rates. Plans containing 4G LTE data will be billed every 30 days by AT&T. You may cancel at any time by pushing your blue OnStar button or calling 1-888-466-7827. May not be combined with other offers or retroactively applied. Offer subject to change. ⁹ Certain features require a SiriusXM subscription and the Chevrolet Connected Access plan. See siriusxm.com and onstar.com for details and limitations. ¹⁰ Not compatible with all devices. ¹¹ Service varies with conditions and location. Requires active service and paid AT&T data plan. Visit onstar.com for details and limitations. Availability subject to change. ¹² Standard connectivity available only to original purchaser for up to 10 years. Connected Access services are subject to change. Does not include emergency or security services. Diagnostic capabilities vary by model and service plan. Message and data rates may apply. Requires contact method on file and enrollment to receive alerts. Not all issues will deliver alerts. Visit onstar.com for details and limitations. ¹³ The system wirelessly charges one compatible mobile device. Some phones have built-in wireless charging technology and others require a special adaptor/back cover. To check for phone or other device compatibility, see my.chevrolet.com/learn or consult your carrier.

SPECIAL EDITIONS



Rally Edition.



Realtree® Special Edition.

● STANDARD ○ AVAILABLE – NOT AVAILABLE

	WT	CUSTOM	CUSTOM TB	LT	RST	LT TB	LTZ	ZR2	HIGH COUNTRY
EXTERIOR									
Rally Edition	-	○	-	-	○	-	-	-	-
Black badges, Black headlamp bezels, Black Chevrolet lettered tailgate, Black rally stripes, 4-inch Black round assist steps, Black exhaust tip(s) and 20" high-gloss Black-painted aluminum wheels (RD5); Custom includes Black bowtie emblem on grille and steering wheel, and Chevytec spray-on bedliner; RST includes Protection Package (Custom and RST not available with any other assist steps or Multi-Flex Tailgate; RST requires Jet Black interior and not available with Z71 Off-Road and Protection Package and Z71 Off-Road Package) (available with Summit White, Sterling Gray Metallic, Red Hot, Glacier Blue Metallic ¹ or Black exterior colors)									
Realtree Special Edition (Crew Cab Short Bed)	-	-	○	-	-	-	-	-	-
Realtree graphics on hood, doors, bed side and tailgate, Black recovery hooks ² ; Chevytec spray-on bedliner with Realtree logo, Realtree interior door trim, Black badges including Silverado, Custom, and Z71, Black headlamp bezels, 4-inch Black round assist steps, dual-outlet exhaust with Black rectangular tips and all-weather floor liners with Z71 logo (requires available 5.3L V8 [L84]) (available with Summit White, Sand Dune Metallic or Black exterior colors)									

[Return To Models](#)

¹ Extra-cost color. ² To avoid the risk of injury, never use recovery hooks to tow a vehicle. For more information, see the Recovery Hooks section of your Owner's Manual.

SPECIAL EDITIONS (CONTINUED)



Midnight Edition.



Redline Edition.

● STANDARD ○ AVAILABLE – NOT AVAILABLE

	WT	CUSTOM	CUSTOM TB	LT	RST	LT TB	LTZ	ZR2	HIGH COUNTRY
EXTERIOR (CONTINUED)									
Midnight Edition	-	-	○	-	-	○	-	-	-
Black Silverado, Z71 and trim badges, Black headlamp bezels, Black recovery hooks; dual-outlet exhaust with Black rectangular tips and Black exterior color; Custom Trail Boss includes Chevytec spray-on bedliner, all-weather floor liners with Z71 logo and Silver-hammer interior trim kit; LT Trail Boss includes Black hood badging with available 6.2L V8 (L87) or Duramax 3.0L Turbo-Diesel I-6 (LZ0) (Custom Trail Boss requires available 5.3L V8 [L84]; LT Trail Boss requires available 5.3L V8 [L84], 6.2L V8 [L87] or Duramax 3.0L Turbo-Diesel I-6 [LZ0], Jet Black interior color, and available LT Trail Boss Premium Package, Leather Package, front bucket seats with center console, and Convenience Package II)									
Redline Edition (Double Cab or Crew Cab Short Bed)	-	-	-	-	○	-	-	-	-
High-gloss Black door handles and grille, Black headlamp bezels, Black Silverado badges with Red outline on fender and tailgate, Black RST badge on tailgate, Black Chevrolet lettered tailgate, Red recovery hooks; Red stripes on outside rearview mirrors, 20" high-gloss Black-painted aluminum wheels with Red accents (RPS), 275/60R20 all-season or all-terrain tires, 4-inch Black round assist steps, dual-outlet exhaust with Black rectangular tips and Protection Package; includes Black hood badging with available 6.2L V8 (L87) or Duramax 3.0L Turbo-Diesel I-6 (LZ0) (requires available 5.3L V8 [L84], 6.2L V8 [L87] or Duramax 3.0L Turbo-Diesel I-6 [LZ0]; not available with Z71 Off-Road and Protection Package and Z71 Off-Road Package) (available with Summit White, Sterling Gray Metallic or Black exterior colors)									

[Return To Models](#)

SPECIAL EDITIONS (CONTINUED)



● STANDARD ○ AVAILABLE – NOT AVAILABLE

EXTERIOR (CONTINUED)

ZR2 Bison Edition

18" AEV-designed gloss Black aluminum wheels, LT275/70R18 Goodyear Wrangler Territory® mud-terrain tires, stamped steel AEV front bumper with winch provisions and AEV rear bumper with heavy-duty recovery points, AEV hot-stamped boron steel skid plates for front differential, engine oil pan, transfer case, fuel tank and rear differential, off-road rocker protection, body-color grille bar, Black vertical recovery hooks,¹ Multi-Flex Tailgate with unique Black finish, AEV embroidered head restraints, and front and rear floor liners with AEV logo (available with Summit White, Red Hot, Sand Dune Metallic, Glacier Blue Metallic² or Black exterior colors)

	WT	CUSTOM	CUSTOM TB	LT	RST	LT TB	LTZ	ZR2	HIGH COUNTRY
ZR2 Bison Edition	-	-	-	-	-	-	-	○	-



ZR2 Bison Edition.

[Return To Models](#)

¹ To avoid the risk of injury, never use recovery hooks to tow a vehicle. For more information, see the Recovery Hooks section of your Owner's Manual. ² Extra-cost color.

AVAILABLE PACKAGES

● STANDARD ○ AVAILABLE – NOT AVAILABLE

	WT	CUSTOM	CUSTOM TB	LT	RST	LT TB	LTZ	ZR2	HIGH COUNTRY
MECHANICAL									
Work Truck Package	○	-	-	-	-	-	-	-	-
Skid plates and heavy-duty air filter (requires available all-terrain tires; not available with Z71 Off-Road Package or Snow Plow Prep Package)									
Snow Plow Prep Package (4x4 models)	○	-	-	○	-	-	-	-	-
Power feed for backup and roof emergency light, 220-amp alternator, heavy-duty air filter, skid plates and heavy-duty front springs (WT requires available 5.3L V8 [L84] and 17" Ultra Silver-painted steel wheels [RD6]; LT requires available Z71 Off-Road Package and 5.3L V8 [L84]; WT not available with Regular Cab Standard Bed; LT not available with Max Trailerling Package)									
Trailerling Package	○	●	●	●	●	●	●	●	●
Trailer hitch, 7-pin and 4-pin connectors, and Hitch Guidance ¹									
Max Trailerling Package	-	-	-	○	○	-	○	-	○
9.76" rear axle, 3.42 axle ratio (3.73 axle ratio with Duramax 3.0L Turbo-Diesel I-6 [LZ0]), enhanced cooling radiator, revised shock tuning for increased control, heavier-duty rear springs, increased RGAWR ² and 220-amp alternator; LT and RST include integrated trailer brake controller (LT requires available 5.3L V8 [L84] or Duramax 3.0L Turbo-Diesel I-6 [LZ0] and 18" or 20" wheels; RST requires available 5.3L V8 [L84], 6.2L V8 [L87] or Duramax 3.0L Turbo-Diesel I-6 [LZ0] and 18" or 20" wheels [Double Cab requires 6.2L V8 (L87) with 20" wheels]; LTZ requires 5.3L V8 [L84] or available 6.2L V8 [L87] or Duramax 3.0L Turbo-Diesel I-6 [LZ0]; High Country requires 4x4 and available 6.2L V8 [L87] or Duramax 3.0L Turbo-Diesel I-6 [LZ0]; LT, RST and LTZ not available with Z71 Off-Road Package; High Country not available with High Country Premium Package, Z71 Off-Road Package or 22" wheels)									

	WT	CUSTOM	CUSTOM TB	LT	RST	LT TB	LTZ	ZR2	HIGH COUNTRY
MECHANICAL (CONTINUED)									
Z71 Off-Road Package (4x4 models)	○	-	-	○	○	-	○	-	○
Off-Road suspension, Hill Descent Control, skid plates and heavy-duty air filter; WT includes Z71 hard badge, automatic locking rear differential and 2-speed transfer case; LT and RST include Z71 hard badge, dual-outlet exhaust with polished rectangular tips, 18" Bright Silver-painted aluminum wheels (RCV), 265/65R18 all-terrain tires and 2-speed transfer case; LTZ includes Z71 hard badge, dual-outlet exhaust with polished rectangular tips, 275/60R20 all-terrain tires and 2-speed transfer case; High Country does not include Z71 badge (WT requires Double Cab or Crew Cab, available 5.3L V8 [L84], all-terrain or LT275/65R18 Goodyear Wrangler DuraTrac [®] mud-terrain tires, and Trailerling Package; LT and RST not available with 2.7L Turbo High-Output [L3B] or Max Trailerling Package; LTZ not available with Max Trailerling Package; High Country not available with High Country Premium Package, Max Trailerling Package or 22" wheels)									
EXTERIOR									
Protection Package	-	-	-	○	○	○	-	-	-
Chevytec spray-on bedliner and rear wheelhouse liners (LT and RST require available all-weather floor liners)									
Z71 Off-Road and Protection Package (4x4 models)	-	-	-	○	○	-	○	-	-
Z71 Off-Road Package and all-weather floor liners; LT and RST include Protection Package; LTZ includes all-terrain tires and Chevytec spray-on bedliner (LT requires available all-terrain tires and 5.3L V8 [L84] or Duramax 3.0L Turbo-Diesel I-6 [LZ0]; RST requires available all-terrain tires and 5.3L V8 [L84], 6.2L V8 [L87] or Duramax 3.0L Turbo-Diesel I-6 [LZ0]; not available with Max Trailerling Package)									

[Return To Models](#)

AVAILABLE PACKAGES (CONTINUED)

● STANDARD ○ AVAILABLE – NOT AVAILABLE

	WT	CUSTOM	CUSTOM TB	LT	RST	LT TB	LTZ	ZR2	HIGH COUNTRY
INTERIOR									
WT Convenience Package	○	-	-	-	-	-	-	-	-
Deep-tinted windows behind front doors, rear-window defogger and cruise control; Double Cab and Crew Cab include heated, power-adjustable outside mirrors									
WT Value Package	○	-	-	-	-	-	-	-	-
WT Convenience Package and Trailerling Package									
WT Safety Package	○	-	-	-	-	-	-	-	-
Rear Park Assist ¹ ; Lane Change Alert with Side Blind Zone Alert ¹ ; Rear Cross Traffic Braking ¹ ; Rear Pedestrian Alert ¹ ; chrome front and rear bumpers, high-gloss Black mirror caps, and perimeter lighting; 2WD models include recovery hooks ² (requires available WT Convenience Package or WT Value Package and 120-volt bed- and instrument panel-mounted power outlets [400 watts shared])									
Custom Value Package	-	●	-	-	-	-	-	-	-
Custom Convenience Package and Trailerling Package									
Custom Convenience Package	-	●	●	-	-	-	-	-	-
Remote vehicle starter system, unauthorized entry theft-deterrent system, rear-window defogger, EZ Lift power lock and release tailgate, and LED cargo area lighting									
Cloth Rear Seat with Storage Package (Crew Cab)	○	○	○	○	○	○	-	-	-
Rear in-seatback left and right storage compartments and center foldout armrest with two cup holders (WT requires available color-keyed carpeting)									
Uplevel Rear Seat with Storage Package (Crew Cab)	-	-	-	○	○	○	●	●	●
Underseat storage, rear in-seatback left and right storage compartments and center foldout armrest with two cup holders (LT, RST and LT Trail Boss require available Leather Package)									

	WT	CUSTOM	CUSTOM TB	LT	RST	LT TB	LTZ	ZR2	HIGH COUNTRY
INTERIOR (CONTINUED)									
Convenience Package	-	-	-	●	●	●	-	-	-
Dual-zone automatic climate control, 10-way power driver seat adjuster with power lumbar control, heated driver and front outboard passenger seats, heated and wrapped steering wheel with mounted audio, cruise and phone controls, manual tilt/telescoping steering column, two charge-only USB ports ³ in second row, rear-window defogger, Keyless Open and Start, remote vehicle starter system and unauthorized entry theft-deterrent system									
Convenience Package II	-	-	-	○	○	○	-	-	-
Universal Home Remote, power-sliding rear window, Hitch Guidance with Hitch View ¹ ; integrated trailer brake controller and Trailerling App; RST and LT Trail Boss include Bose premium 7-speaker sound system (RST and LT Trail Boss require available front bucket seats with center console)									
Leather Package	-	-	-	○	○	○	-	-	-
Leather-appointed front seats; Crew Cab includes Uplevel Rear Seat with Storage Package (LT requires available Convenience Package II; RST and LT Trail Boss require available front bucket seats with center console and Convenience Package II)									
Safety Package	-	-	-	○	○	○	●	-	-
HD Surround Vision ¹ ; Trailer Camera Provisions ¹ ; Trailer Side Blind Zone Alert ¹ ; Rear Cross Traffic Braking ¹ ; Rear Pedestrian Alert ¹ and perimeter lighting; LT 2WD models include front recovery hooks ² ; LT, RST and LT Trail Boss include Rear Park Assist ¹ ; LTZ includes Front and Rear Park Assist ¹ (LT, RST and LT Trail Boss require available Convenience Package II and integrated trailer brake controller)									

Return To Models

¹ Safety or driver assistance features are no substitute for the driver's responsibility to operate the vehicle in a safe manner. Read the vehicle Owner's Manual for important feature limitations and information. ² To avoid the risk of injury, never use recovery hooks to tow a vehicle. For more information, see the Recovery Hooks section of your Owner's Manual. ³ Not compatible with all devices.

AVAILABLE PACKAGES (CONTINUED)

● STANDARD ○ AVAILABLE – NOT AVAILABLE

	WT	CUSTOM	CUSTOM TB	LT	RST	LT TB	LTZ	ZR2	HIGH COUNTRY
INTERIOR (CONTINUED)									
All Star Edition	-	-	-	●	●	-	-	-	-
Convenience Package (available in Arkansas, Louisiana, New Mexico, Oklahoma and Texas with Texas Edition badging)									
All Star Edition Plus	-	-	-	○	○	-	-	-	-
Convenience Package II and 20" machined-face painted-aluminum wheels with Grazen-painted pockets (NZN) (RST requires available front bucket seats with center console; not available with Texas Edition Plus)									
Texas Edition Plus	-	-	-	○	○	-	-	-	-
Convenience Package II, 20" machined-face painted-aluminum wheels with Grazen-painted pockets (NZN) and Texas Edition badging (RST requires available front bucket seats with center console; available in Arkansas, Louisiana, New Mexico, Oklahoma and Texas; not available with All Star Edition Plus)									
RST All Star Premium Package	-	-	-	-	○	-	-	-	-
All Star Edition Plus, Safety Package, Adaptive Cruise Control ¹ , Leather Package and Protection Package (requires available front bucket seats with center console; not available with Texas Edition Plus, RST Texas Edition Premium Package or Redline Edition)									
RST Texas Edition Premium Package	-	-	-	-	○	-	-	-	-
Texas Edition Plus, Safety Package, Adaptive Cruise Control ¹ , Leather Package, Protection Package and Texas Edition badging (requires available front bucket seats with center console; available in Arkansas, Louisiana, New Mexico, Oklahoma and Texas; not available with All Star Edition Plus, RST All Star Premium Package or Redline Edition)									
LT Trail Boss Premium Package	-	-	-	-	-	○	-	-	-
Convenience Package II, Safety Package, Leather Package, Protection Package and power-up/-down tailgate (requires available front bucket seats with center console)									
LTZ Convenience Package	-	-	-	-	-	-	●	-	-
Front bucket seats with center console, 10-way power front seat adjusters with power lumbar control, heated and ventilated front seats, Bose premium 7-speaker sound system, power tilt/telescoping steering column, two additional USB ports ² in center console and wireless charging ³ (wireless charging feature will not function on certain models; see dealer for details or the window label for features on a specific vehicle)									

	WT	CUSTOM	CUSTOM TB	LT	RST	LT TB	LTZ	ZR2	HIGH COUNTRY
INTERIOR (CONTINUED)									
LTZ Plus Package	-	-	-	-	-	-	●	-	-
LTZ Convenience Package and Safety Package (available in Arkansas, Louisiana, New Mexico, Oklahoma and Texas with Texas Edition badging)									
LTZ Convenience Package II	-	-	-	-	-	-	○	-	-
Universal Home Remote, Adaptive Cruise Control ¹ , power-sliding rear window and heated rear outboard seats									
LTZ Premium Package	-	-	-	-	-	-	○	-	-
LTZ Convenience Package II and power sunroof (not available with LTZ Premium Texas Edition)									
LTZ Premium Texas Edition	-	-	-	-	-	-	○	-	-
LTZ Convenience Package II, power sunroof and Texas Edition badging (available in Arkansas, Louisiana, New Mexico, Oklahoma and Texas; not available with LTZ Premium Package)									
Technology Package	-	-	-	-	-	-	○	○	○
Rear Camera Mirror ¹ and Head-Up Display; LTZ includes Bed View Camera ¹ ; ZR2 includes Adaptive Cruise Control ¹ and power tilt/telescoping steering column; High Country includes Adaptive Cruise Control ¹ (LTZ requires available LTZ Convenience Package II, LTZ Premium Package or LTZ Premium Texas Edition)									
High Country Premium Package	-	-	-	-	-	-	-	-	○
Power sunroof, 22" painted-aluminum wheels with chrome inserts (RPT), 275/50R22 all-season tires and all-weather floor liners (requires available Adaptive Ride Control suspension; not available with Z71 Off-Road Package or Max Trailerling Package)									
High Country Premium Package II	-	-	-	-	-	-	-	-	○
High Country Premium Package, Technology Package, Super Cruise ⁴ hands-free driver assistance technology and power-retractable assist steps (requires Crew Cab Short Bed and available 6.2L V8 [L87] or Duramax 3.0L Turbo-Diesel I-6 [LZ0] and Adaptive Ride Control suspension; not available with Z71 Off-Road Package or Max Trailerling Package)									

[Return To Models](#)

¹ Safety or driver assistance features are no substitute for the driver's responsibility to operate the vehicle in a safe manner. Read the vehicle Owner's Manual for important feature limitations and information. ² Not compatible with all devices. ³ The system wirelessly charges one compatible mobile device. Some phones have built-in wireless charging technology and others require a special adaptor/back cover. To check for phone or other device compatibility, see my.chevrolet.com/learn or consult your carrier. ⁴ Always pay attention while driving and when using Super Cruise. Do not use a hand-held device. Requires active Super Cruise plan or trial. Terms apply. Visit chevrolet.com/supercruise for compatible roads and full details.

ENGINE SPECIFICATIONS



2.7L TURBO HIGH-OUTPUT (L3B)

Standard on WT, Custom, Custom Trail Boss, LT, RST Double Cab and LT Trail Boss.

Equipped with Active Fuel Management™ and Automatic Stop/Start

8-speed automatic transmission

310 hp @ 5600 rpm

430 lb.-ft. of torque @ 3000 rpm

Displacement: 2726 cc (166 cu. in.)

Bore and stroke: 92.25 mm x 102 mm (3.63 in. x 4.01 in.)

Compression ratio: 10.0:1

Alternator: 220 amps

Block: Cast-aluminum

Cylinder head: Cast-aluminum

Valvetrain: Dual overhead valve with 4 valves per cylinder and Variable Valve Timing (VVT)

Fuel delivery: Direct Injection

Max payload rating: 2,260 lbs^{1,2}

Max conventional trailerling weight rating: 9,500 lbs^{3,4}

EPA-estimated fuel economy – 2WD: 19 MPG city/22 highway

EPA-estimated fuel economy – 4x4: 18 MPG city/21 highway

EPA-estimated fuel economy – Trail Boss 4x4: 17 MPG city/18 highway



5.3L ECOTEC3 V8 (L84) Standard on RST Crew Cab, LTZ and High Country. Available on WT,⁵ Custom Trail Boss, LT and RST Double Cab 2WD models.

Equipped with Dynamic Fuel Management and Automatic Stop/Start

10-speed automatic transmission

355 hp @ 5600 rpm

383 lb.-ft. of torque @ 4100 rpm

Displacement: 5328 cc (325 cu. in.)

Bore and stroke: 96.01 mm x 92 mm (3.78 in. x 3.62 in.)

Compression ratio: 11.0:1

Alternator: 170 amps

Block: Cast-aluminum

Cylinder head: Cast-aluminum

Valvetrain: Overhead valve with 2 valves per cylinder and Variable Valve Timing (VVT)

Fuel delivery: Direct Injection

Max payload rating: 2,140 lbs^{1,4}

Max conventional trailerling weight rating: 11,300 lbs^{3,6}

EPA-estimated fuel economy – 2WD: 17 MPG city/21 highway

EPA-estimated fuel economy – 4x4: 16 MPG city/20 highway

EPA-estimated fuel economy – Trail Boss 4x4: 15 MPG city/19 highway

¹ These maximum payload ratings are intended for comparison purposes only. Before you buy a vehicle or use it to haul people or cargo, carefully review the Vehicle Loading section of the Owner's Manual and check the carrying capacity of your specific vehicle on the label on the inside of the driver door jamb. ² Requires Silverado Regular Cab Standard or Long Bed 2WD. ³ Maximum trailerling ratings are intended for comparison purposes only. Before you buy a vehicle or use it for trailerling, carefully review the Trailerling section of the Owner's Manual. The trailerling capacity of your specific vehicle may vary. The weight of passengers, cargo and options or accessories may reduce the amount you can trailer. ⁴ Requires Silverado Regular Cab Long Bed 2WD. ⁵ Not available on Regular Cab Standard Bed WT 2WD. ⁶ Requires Silverado Double Cab Standard Bed 2WD with available Max Trailerling Package or Silverado Crew Cab Short Bed 2WD with available Max Trailerling Package.

ENGINE SPECIFICATIONS (CONTINUED)



6.2L ECOTEC3 V8 (L87)

Standard on ZR2. Available on RST, LT Trail Boss, LTZ and High Country 4x4 models.

Equipped with Dynamic Fuel Management and Automatic Stop/Start

10-speed automatic transmission

420 hp @ 5600 rpm

460 lb.-ft. of torque @ 4100 rpm

Displacement: 6162 cc (376 cu. in.)

Bore and stroke: 103.25 mm x 92 mm (4.06 in. x 3.62 in.)

Compression ratio: 11.0:1

Alternator: 170 amps

Block: Cast-aluminum

Cylinder head: Cast-aluminum

Valvetrain: Overhead valve with 2 valves per cylinder and Variable Valve Timing (VVT)

Fuel delivery: Direct Injection

Max payload rating: 1,980 lbs.^{1,2}

Max conventional trailerling weight rating: 13,300 lbs.^{3,4}

EPA-estimated fuel economy – 4x4: 16 MPG city/20 highway

EPA-estimated fuel economy – Trail Boss 4x4: 14 MPG city/18 highway

EPA-estimated fuel economy – ZR2: 14 MPG city/17 highway



DURAMAX 3.0L TURBO-DIESEL I-6 (LZ0)

Available on LT, RST, LT Trail Boss, LTZ and High Country 4x4 models.

Equipped with Diesel Exhaust Brake System

10-speed automatic transmission

305 hp @ 3750 rpm

495 lb.-ft. of torque @ 2750 rpm

Displacement: 2992 cc (183 cu. in.)

Bore and stroke: 84 mm x 90 mm (3.30 in. x 3.54 in.)

Compression ratio: 15.0:1

Alternator: 220 amps

Block: Cast-aluminum

Cylinder head: Cast-aluminum

Valvetrain: Dual overhead valve with 4 valves per cylinder

Fuel delivery: High-pressure, common rail Direct Injection

Max payload rating: 1,970 lbs.^{1,5}

Max conventional trailerling weight rating: 13,300 lbs.^{3,6}

EPA-estimated fuel economy – 2WD: 24 MPG city/29 highway

EPA-estimated fuel economy – 4x4: 22 MPG city/27 highway

EPA-estimated fuel economy – Trail Boss 4x4: 21 MPG city/23 highway

¹ These maximum payload ratings are intended for comparison purposes only. Before you buy a vehicle or use it to haul people or cargo, carefully review the Vehicle Loading section of the Owner's Manual and check the carrying capacity of your specific vehicle on the label on the inside of the driver door jamb. ² Requires Silverado Crew Cab Short Bed 4x4 with available Max Trailerling Package and 18" or 20" wheels. ³ Maximum trailerling ratings are intended for comparison purposes only. Before you buy a vehicle or use it for trailerling, carefully review the Trailerling section of the Owner's Manual. The trailerling capacity of your specific vehicle may vary. The weight of passengers, cargo and options or accessories may reduce the amount you can trailer. ⁴ Requires Silverado Double Cab Standard Bed RST 4x4 with available Max Trailerling Package and 20" wheels. ⁵ Requires Silverado Double Cab Standard Bed 2WD with available Max Trailerling Package and 18" or 20" wheels. ⁶ Requires Silverado Double Cab Standard Bed 2WD or Crew Cab Short Bed 2WD with available Max Trailerling Package and 20" wheels.

MAXIMUM CAPACITIES

	REGULAR CAB	DOUBLE CAB	CREW CAB
Fuel tank (approximate)	24 gallons – Standard Bed 28 gallons – Long Bed	22 gallons – 2WD Duramax 24 gallons	22 gallons – Short Bed 2WD Duramax 24 gallons
Cargo volume ¹	71.7 cubic feet – Standard Bed 89.1 cubic feet – Long Bed	71.7 cubic feet – Standard Bed	62.9 cubic feet – Short Bed 71.7 cubic feet – Standard Bed

DIMENSIONS

	REGULAR CAB	DOUBLE CAB	CREW CAB
A – Width	81.1"	81.2"	81.2"
B – Height	75.7" – Standard Bed 2WD 75.9" – Standard Bed 4x4 75.6" – Long Bed	75.6"	75.5" – Short Bed 78.4" – Short Bed Trail Boss 78.7" – Short Bed ZR2 75.4" – Standard Bed 78.2" – Standard Bed Trail Boss
C – Wheelbase	126.5" – Standard Bed 139.6" – Long Bed	147.5"	147.4" – Short Bed 147.5" – Short Bed Trail Boss/ZR2 157.0" – Standard Bed 157.1" – Standard Bed Trail Boss
D – Length	210.9" – Standard Bed 229.6" – Long Bed	231.9"	231.9" – Short Bed 232.9" – Short Bed Trail Boss 232.8" – Short Bed ZR2 241.4" – Standard Bed 242.4" – Standard Bed Trail Boss
E – Inside bed height	22.4"	22.4"	22.4"
F – Bed width wall to wall	71.4"	71.4"	71.4"
G – Inside width between wheelhousings	50.6"	50.6"	50.6"
H – Inside bed length at floor	79.4" – Standard Bed 98.2" – Long Bed	79.4"	69.9" – Short Bed 79.4" – Standard Bed
Head room (front/rear)	43.1"/-	43.0"/39.9"	43.0"/40.1"
Leg room (front/rear)	44.5"/-	44.5"/35.2"	44.5"/43.4"
Shoulder room (front/rear)	66.0"/-	66.0"/64.9"	66.0"/65.2" 64.5"/64.0" – ZR2
Hip room (front/rear)	60.9"/-	61.2"/60.2"	61.2"/60.2" 60.8"/59.3" – ZR2

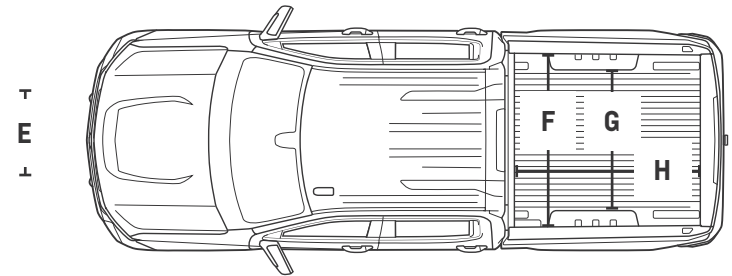
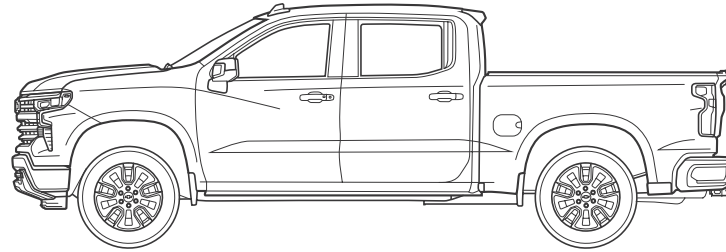
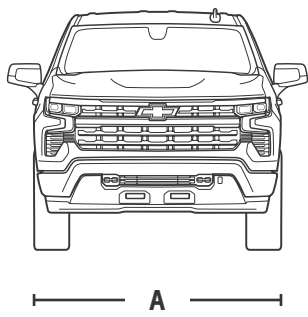

¹ Cargo and load capacity limited by weight and distribution.



Premium All-Weather Floor Liners in Jet Black with Chevrolet Script available from Chevrolet Accessories!



Hard Folding Tonneau Cover by REV available from Chevrolet Accessories!



Off-Road High-Clearance Assist Steps in Black with Silverado Script available from Chevrolet Accessories!

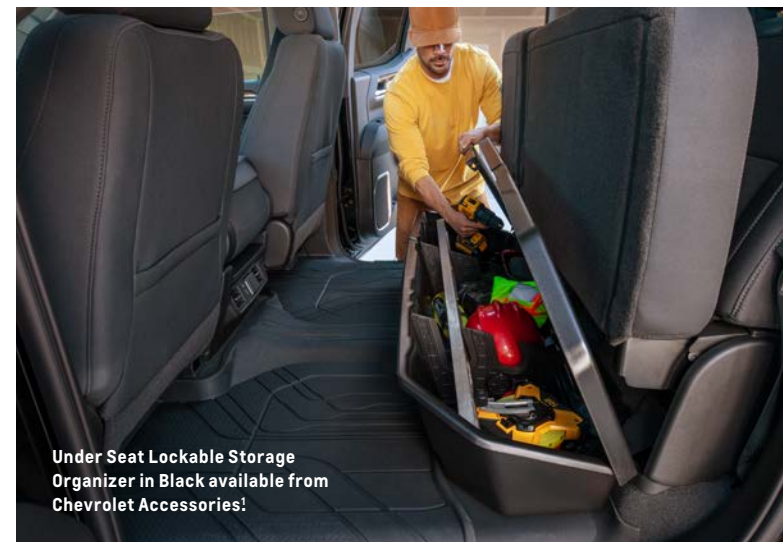

Under Seat Lockable Storage Organizer in Black available from Chevrolet Accessories!



IMPORTANT INFORMATION.

You may be discovering Chevrolet through a personalized online shopping experience or enjoying every year of vehicle ownership. Either way, we're committed to providing the tools and programs you need to help you get the most out of your journey.

Build & Price >

Create your perfect Chevrolet from start to finish.

Chevy MyWay¹ >

Engage in a real-time virtual video experience with a Chevy product specialist.

Chevrolet Complete Care >

Enjoy an owner benefit program that provides excellent service and support from day one.

My Chevrolet Rewards² >

Unlock a world of appreciation that's all about you and your Chevrolet. Start earning and redeeming today.

Chevy Truck Legends >

Honoring our dependable, long-lasting trucks and the people who keep them going strong.

Limited Warranty Coverage >

Discover all the ways Chevrolet is committed to providing an excellent ownership experience.



GM, the GM logo, Chevrolet, the Chevrolet logo, and the slogans, emblems, vehicle model names, vehicle body designs and other marks appearing in this brochure are the trademarks and/or service marks of General Motors, its subsidiaries, affiliates or licensors. ©2022 OnStar LLC. All rights reserved. Sirius, XM, SiriusXM and all related marks and logos are trademarks of Sirius XM Radio Inc. The Bluetooth word mark is a registered trademark owned by Bluetooth SIG, Inc., and any use of such mark by Chevrolet is under license. Bose is a registered trademark of the Bose Corp. Goodyear, Wrangler DuraTrac and Wrangler Territory are registered trademarks of The Goodyear Tire & Rubber Company.

©2022 General Motors. All rights reserved. October 2022

FIND NEW ROADS[™]

CHEVROLET.COM

¹ Chevy MyWay is available to anyone over 18 in the United States to access and experience via [chevrolet.com/myway](#). ² Must be 18 years or older. Points may be earned and redeemed only at GM entities, My Chevrolet Rewards participating dealers or third party retailers in the United States (excluding Puerto Rico, the U.S. Virgin Islands or Guam). Points are not earned on taxes, fees or body shop repair orders and expire without further notice upon Member Account deactivation. Visit [myChevroletrewards.com](#) to view My GM Rewards Terms & Conditions.