



RAV4 EV  
2 0 1 4



VEHICLE CHARGING  
AND OPERATIONS  
QUICK REFERENCE GUIDE

# 2014 RAV4 EV

This *Quick Reference Guide* is a summary of basic vehicle operations. It contains brief descriptions of fundamental operations so you can locate and use the vehicle's main equipment quickly and easily.

The *Quick Reference Guide* is not intended as a substitute for the *Owner's Manual* located in the vehicle's glove box. We strongly encourage you to review the *Owner's Manual* and supplementary manuals so you will have a better understanding of the vehicle's capabilities and limitations.

Your dealership and the entire staff of Toyota Motor Sales, U.S.A., Inc. wish you many years of satisfied driving in your new RAV4 EV.

## A word about safe vehicle operations

This *Quick Reference Guide* is not a full description of RAV4 EV operations. Every RAV4 EV owner should review the *Owner's Manual* that accompanies this vehicle.

Pay special attention to the boxed information highlighted in color throughout the *Owner's Manual*. Each box contains safe operating instructions to help you avoid injury or equipment malfunction.

All information in this *Quick Reference Guide* is current at the time of printing. Toyota reserves the right to make changes at any time without notice.

# INDEX

## OVERVIEW

Charge port	8
Hood release	8
Indicator symbols	4-5
Instrument cluster	4
Instrument panel	2-3
<i>Keyless entry*</i>	6
Motor maintenance	9
<i>Smart Key system*</i>	7

## ELECTRIC VEHICLE SYSTEM

Charging	19-24
Charging cable-Plugging in	14-17
Charging cable-Unplugging	18
Charging equipment	12
Charging-Power sources	13
Confirming charge settings	28
Electric Vehicle System	10
Extended charge mode	25-26
Inspecting electrical leakage detection function	29
Multi-Information Display-Charging information	27-28
Range Map screen	11

## FEATURES/OPERATIONS

Air Conditioning/Heating	37
Clock	38
Cruise control	41
Door locks	35
Hill-start Assist Control (HAC)	43
iPod®/USB/AUX port	40
Light control-Instrument panel	35
Lights & turn signals	33
Multi-Information Display	42
Navigation system	38-39
Parking brake	30
Power outlets-12V DC	42
Seat adjustments-Front	31
Seat adjustments-Rear	31
Seat heaters	37
Seats-Folding down rear seats	32
Seats-Head restraints	32
Steering wheel switches	40
Telephone controls (Bluetooth®)	36
Tilt and telescopic steering wheel	41
Transmission	30
VSC OFF button	43
Windows-Power	34
Windshield wipers & washers	34

## SAFETY AND EMERGENCY FEATURES

Doors-Child safety locks	44
Emergency tire puncture repair kit	45
Floor mat installation	47
Seat belts	44
Seat belts-Shoulder belt anchor	45
Star Safety System™	46-47
Tire Pressure Monitoring (warning) System	45

\* Visit your Toyota dealer for information on customizing this feature.

# OVERVIEW

## Instrument panel

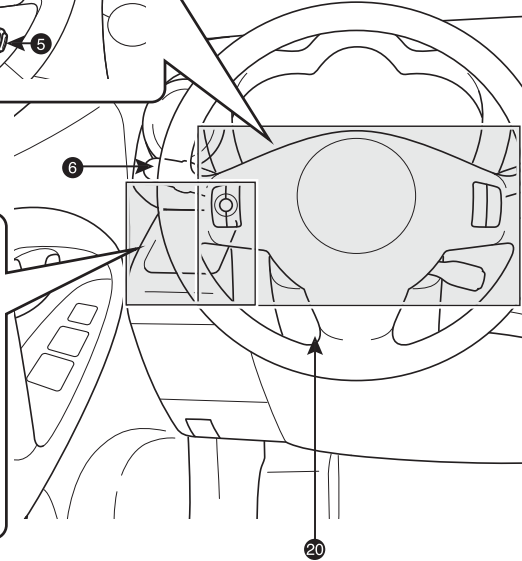
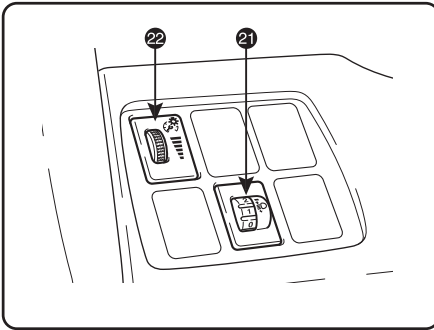
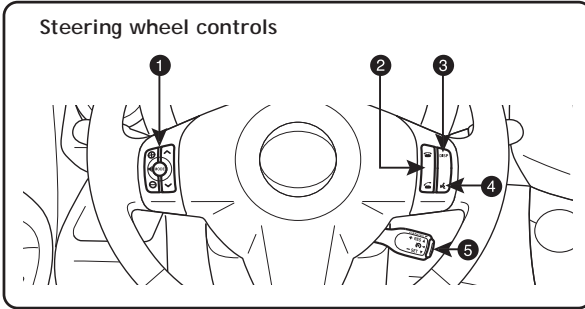

- ❶ Steering wheel audio controls\*
- ❷ Telephone controls\*
- ❸ Multi-Information Display switch
- ❹ Speech command button\*
- ❺ Cruise control
- ❻ Headlight and turn signal control
- ❼ Wiper and washer controls
- ❽ Emergency flasher switch
- ❾ Navigation/Audio system\*
- ❿ Power button
- ⓫ Immobilizer indicator
- ⓬ Clock and HVAC display
- ⓭ Front passenger occupant classification indicator
- ⓮ Air Conditioning controls
- ⓯ Seat heater controls

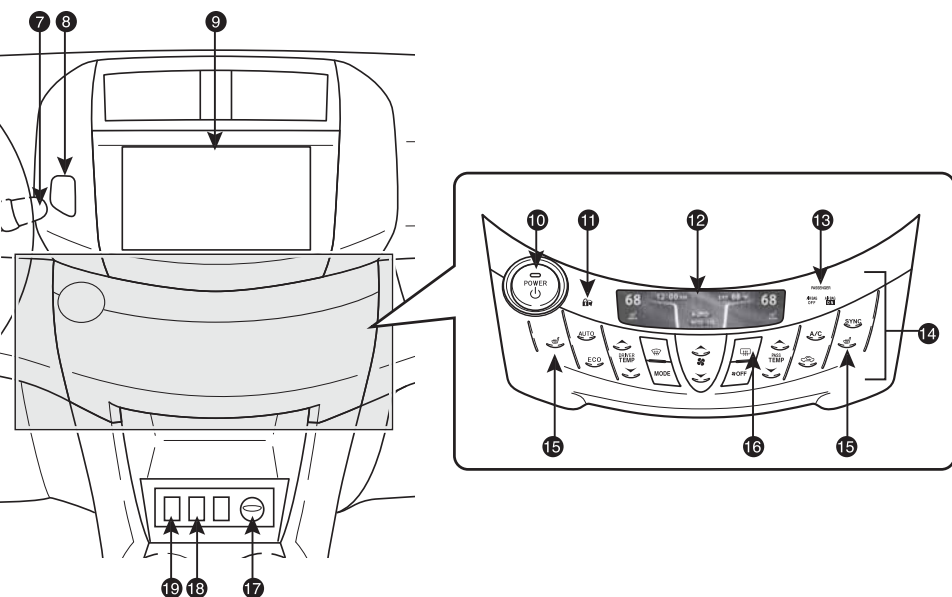







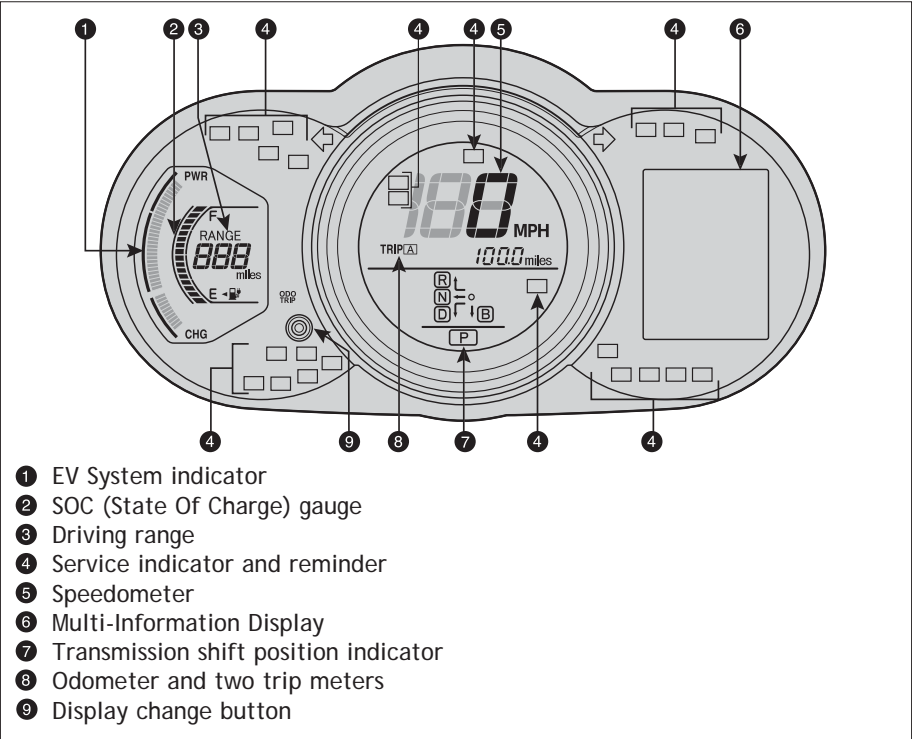

- 16 Rear window and outside rearview mirror defogger switch
- 17 12V DC power outlet
- 18 SPORT mode switch
- 19 VSC OFF switch
- 20 Tilt and telescopic steering release
- 21 Manual headlight leveling dial
- 22 Instrument panel light control

\* For details, refer to the "Navigation System Owner's Manual."

















**Instrument cluster**



**Indicator symbols**

-  Brake system warning (red)<sup>1</sup>
-  Brake system warning (yellow)<sup>1</sup>
-  Driver/Front passenger seat belt reminder (alarm will sound if speed is over 12 mph)
-  12-volt battery charging system warning<sup>1</sup>
-  Plug-in indicator (yellow/green)
-  Output control warning
-  SOC (state of charge) warning
-  Master warning
-  Open door warning

<sup>1</sup> If indicator does not turn off within a few seconds of starting EV System, there may be a malfunction. Have vehicle inspected by your Toyota dealer.

	SRS Airbag warning <sup>1</sup>
	Low Tire Pressure Warning <sup>1</sup>
	Electric power steering system warning <sup>1</sup>
	Front passenger occupant classification indicator <sup>1</sup>
	Headlight low/high beam indicator
	Turn signal indicator
	Transmission shift position indicator
	Vehicle Stability Control (VSC) OFF indicator <sup>1</sup>
	Slip indicator/Hill-start Assist Control (HAC) indicator <sup>1</sup>
	<b>SET</b> Cruise control indicator <sup>2</sup> /Cruise control SET indicator <sup>2</sup>
	<b>ABS</b> Anti-lock Brake System warning <sup>1</sup>
	<b>TRAC OFF</b> Traction Control OFF indicator <sup>1</sup>
	<b>SPORT</b> SPORT mode indicator
	Immobilizer indicator
	<b>ECO</b> ECO Driving Indicator Light <sup>1</sup>
	<b>READY</b> READY indicator
	Charging indicator

<sup>2</sup> If this light flashes, refer to "Cruise control," Section 2-4, 2014 Owner's Manual.

## Keyless entry

Beep sound can be switched ON or OFF. Refer to the *Owner's Manual* for more details.

### Locking operation



Push 

### Unlocking operation



Push ONCE: Driver door   
TWICE: All doors

**NOTE:** If a door is not opened within 60 seconds of unlocking, all doors will relock for safety.

### Panic button



Push and hold 



# Smart Key system

## Start function

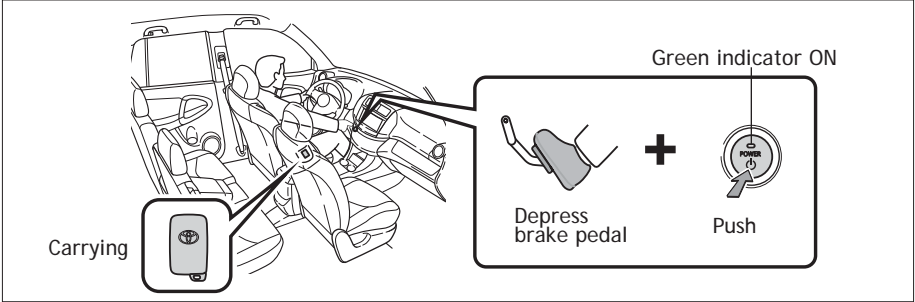

**NOTE:** Shift position must be in Park and brake pedal depressed.

## Power (without starting EV System)

Without depressing the brake pedal, pressing the "POWER" switch will change the operation mode in succession from:

- ACCESSORY** Accessories such as the radio will operate.
- ON** Power ON; the EV System is not engaged.
- OFF** All systems OFF.

## Locking operation

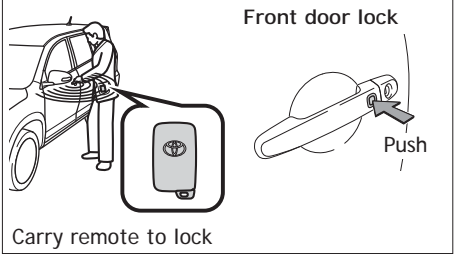

## Unlocking operation

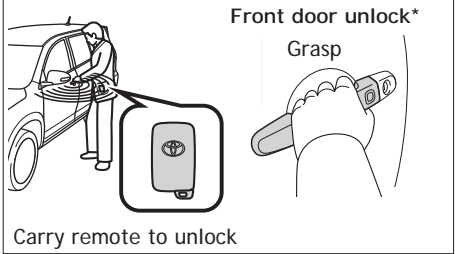

## Back door lock/unlock

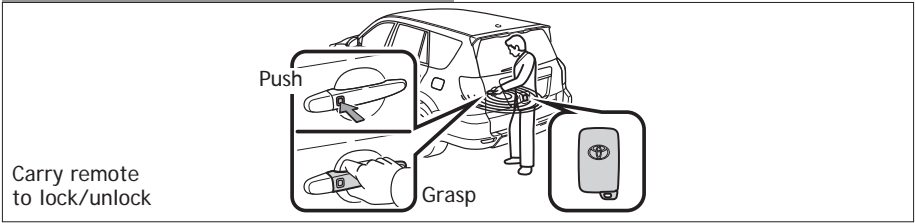

\* Driver door unlocking function can be programmed to unlock driver door only, or all doors. Grasping passenger door handle or back door opener will unlock all doors.

**NOTE:** Doors may also be locked/unlocked using remote.

### Charge port

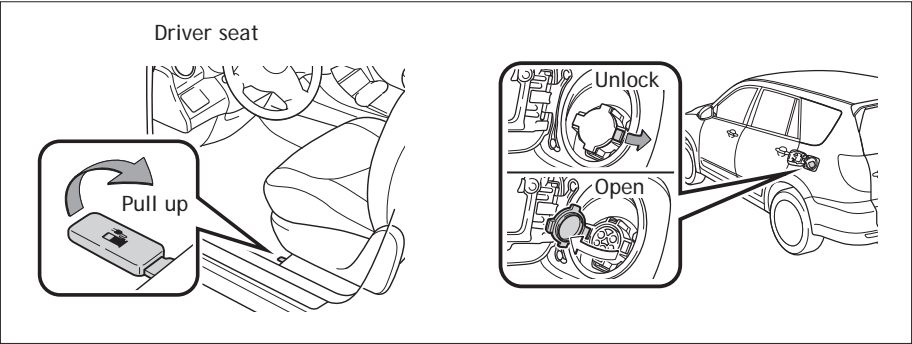

### Hood release

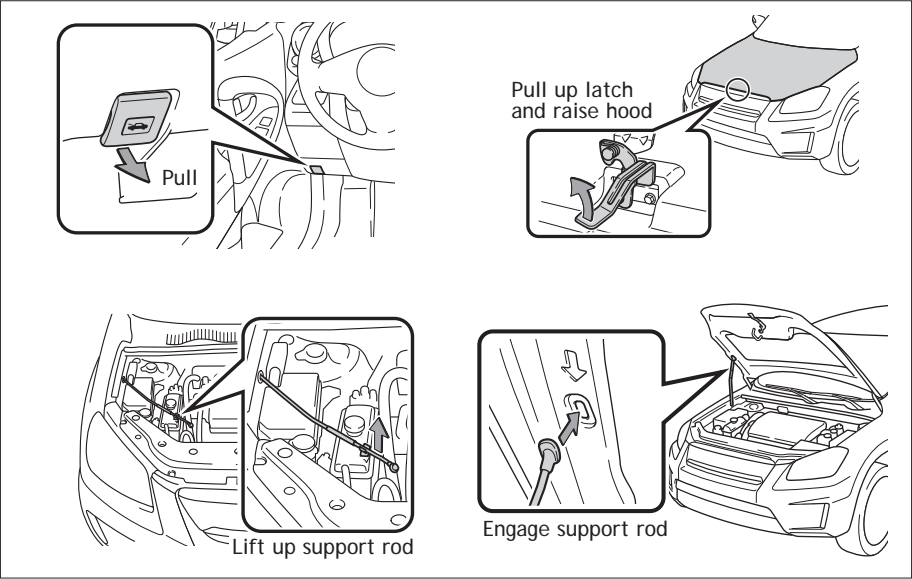

## Motor maintenance

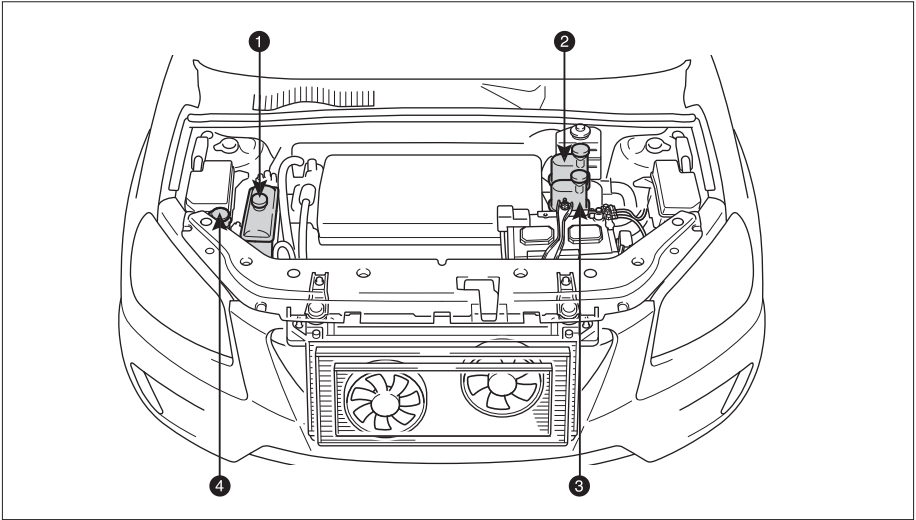

- ① Motor coolant reservoir
- ② Heater coolant reservoir
- ③ Traction battery coolant reservoir
- ④ Windshield and back window washer fluid tank

**NOTE:** Regularly scheduled maintenance will help extend the life of your vehicle and maintain performance. Please refer to the "Warranty Maintenance Guide."

# ELECTRIC VEHICLE SYSTEM

## Electric Vehicle System

The RAV4 EV uses electricity in a rechargeable traction battery to power the electric motor. The driving range is extended by using regenerative braking to store electricity in the traction battery. This technology is clean and has a low impact on the environment by not emitting exhaust such as CO<sub>2</sub> or NO<sub>x</sub> during operation.

### Tips for reducing battery consumption

- Keep the EV System indicator needle within the ECO area.
- Drive in normal mode.
- When possible, avoid driving on steep inclines.
- Avoid driving at speeds that are higher than necessary, especially on the highway.
- When possible, avoid sudden stops to maximize regenerative braking energy.
- Minimize use of Air Conditioning and heating; the seat heater may also be used to supplement heating.
- Maintain recommended tire pressure and avoid carrying unnecessary luggage.
- Utilize the Pre-climate function to warm or cool cabin before driving.

### Starting the EV System

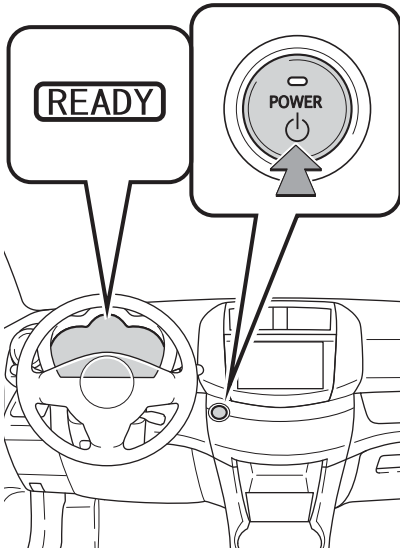

- (1) Depress the brake pedal, and press the "POWER" switch while in Park.
- (2) After a few seconds the "READY" light comes on and a beep sounds.

## Range Map screen

The driving area possible on the current charge level can be displayed as a reference, as can charge stations in the surrounding area.

Refer to the *Owner's Manual* for more details.

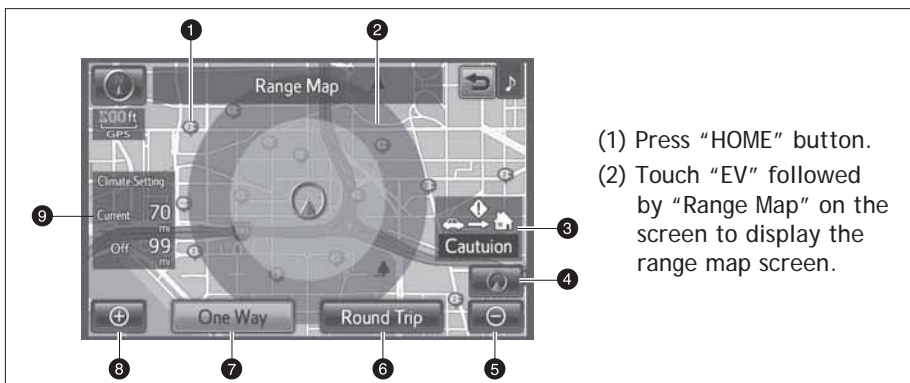

- (1) Press "HOME" button.
- (2) Touch "EV" followed by "Range Map" on the screen to display the range map screen.

- 1 Charge station
- 2 Range circle
- 3 Reachable destination guidance
- 4 Current position
- 5 Zoom out button
- 6 Display round trip driving range
- 7 Display one-way driving range
- 8 Zoom in button
- 9 Climate setting

## Charging equipment

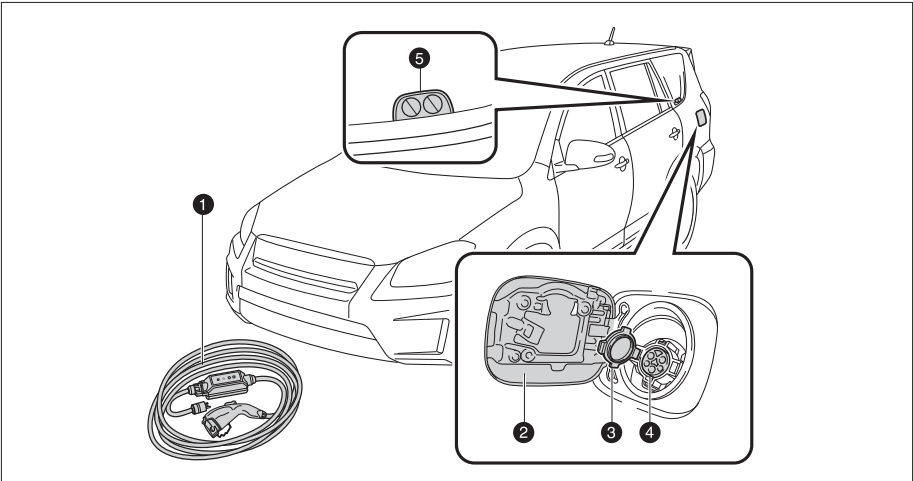

- ① Charging cable
- ② Charging port door
- ③ Charging port cap
- ④ Charging port
- ⑤ Charging indicator

The charging cable included with the vehicle is designed to be connected only to an AC 120V power source.

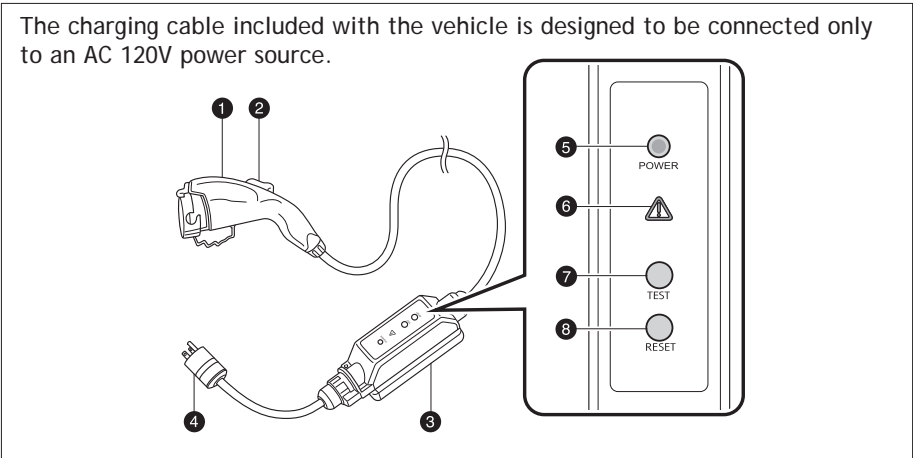

- ① Charging connector
- ② Latch release button
- ③ CCID (Charging Circuit Interrupting Device)
- ④ Plug
- ⑤ Power indicator
- ⑥ Error warning indicator
- ⑦ Test button
- ⑧ Reset button

## Charging-Power sources

A Level 1 charging cable is provided with your RAV4 EV. However, a Level 2 (240V) charging station is strongly recommended. Level 2 charging offers a faster charge time than AC 120V charging. Please contact your Authorized Toyota RAV4 EV Dealer for more information on obtaining a Level 2 charging station for your home.

-Connect your Level 1 charging cable to an AC 120V electrical receptacle (NEMA 5-15R or NEMA 5-20R) with a Ground-Fault Circuit-Interrupter (GFCI) and an over current circuit breaker in the service panel.

-Toyota recommends using a dedicated receptacle with a single socket. If the receptacle has two sockets, do not plug any other item into the other socket.

-For public charging, this vehicle may only be charged at stations that are SAE J1772 compliant. Use your navigation system to search for nearby public charging stations.

-When charging outdoors, be sure to connect to a rain tight electrical receptacle that is appropriate for outdoor use.

**NOTE:** Do not attempt to use a damaged or loose electrical receptacle to charge your vehicle.

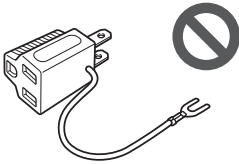

Do not connect the charging cable to a multi-outlet adapter, multi-plugs, or conversion plug.

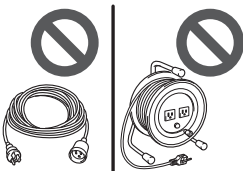

Do not connect the charging cable to an extension cable. The cable may overheat and does not contain a Ground-Fault Circuit-Interrupter (GFCI).

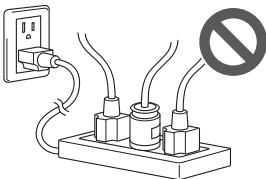

Do not connect to a power strip.

See the *Owner's Manual* for important precautionary information.

## Charging cable-Plugging in

Step 1 Plug the charging cable into the electrical receptacle of the external power source.

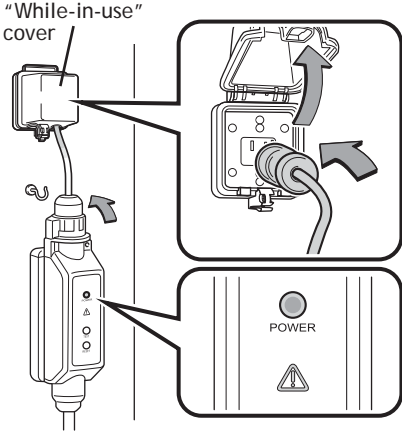

"While-in-use" cover

- Ensure that the standards of the electrical receptacle and the charging cable's plug match.
- Check that the power indicator of the CCID (Charging Circuit Interrupting Device) is illuminated.
- Hanging the CCID on a hook is recommended to reduce the strain on the electrical receptacle and charging cable plug.
- When charging outdoors, use a "while-in-use" cover.

Step 2 Press the test button on the CCID to check that the electrical leakage detection function operates properly.

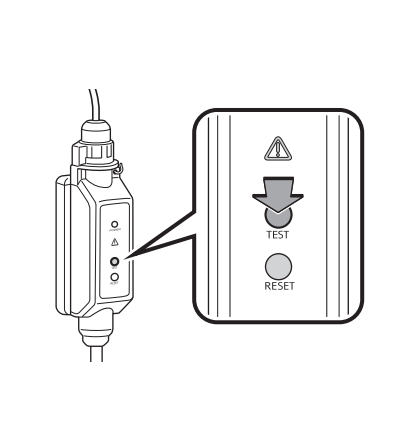

- If the error warning indicator illuminates when test button is pressed, the function is operating correctly.
- After the test is completed, press reset button to turn off the error warning. Charging cannot occur while error warning is illuminated.
- If the error warning indicator does not come on when test button is pressed, the function may not be operating correctly. Stop charging immediately and contact your Toyota dealer.



Step 3 Pull up the charging port door lever.

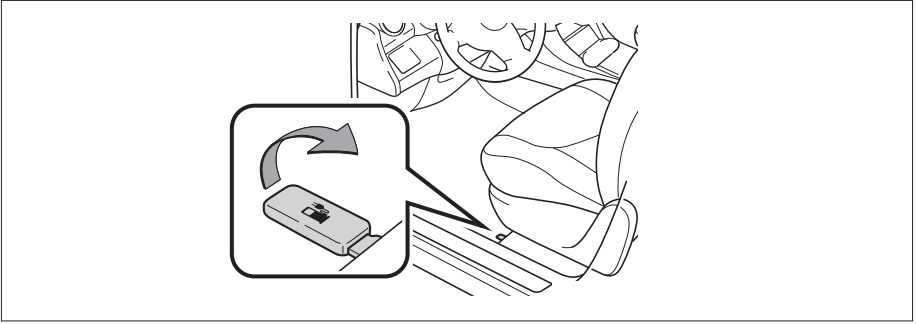

Step 4 Open the charging port cap by releasing the clip.

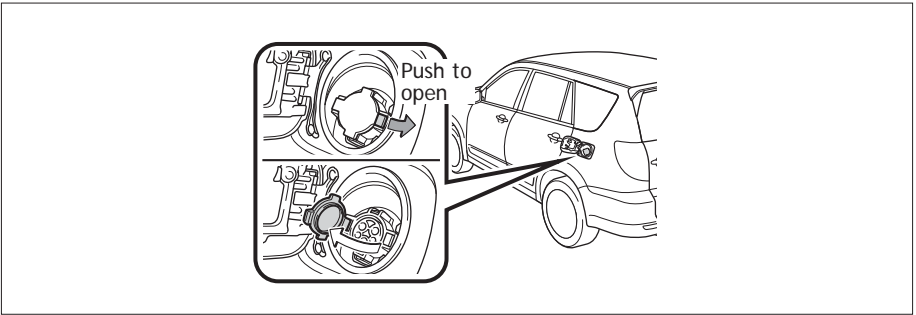

Step 5 Remove the charging connector cap. Affix the cap to the cable.

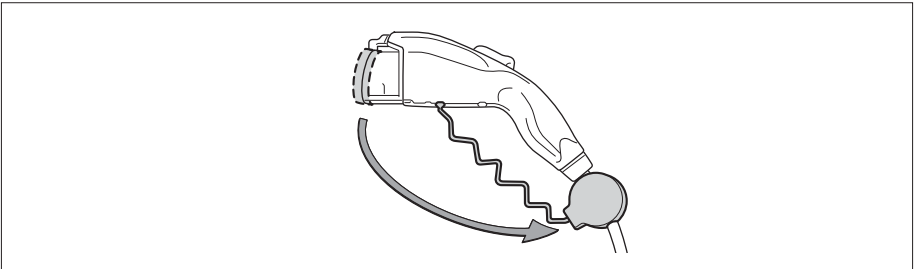

## ELECTRIC VEHICLE SYSTEM

**Step 6** Insert the charging cable connector into the charging port.

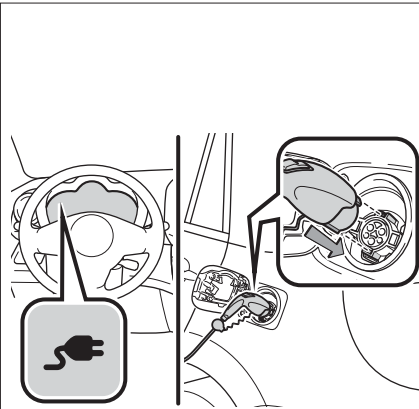

- Do not press the latch release button when inserting the connector.
- Align with the guide position shown on underside of the charging connector, and push it in straight and firmly until it clicks. Confirm connector is securely locked.
- The plug-in indicator on the meter illuminates in green if correctly plugged in. Incorrect plug-in results in a yellow plug-in indicator.
- If no schedule is set, or the charge immediately function is selected, charging will begin by simply plugging in the charging cable.
- If EV System is on when the vehicle is plugged in, the READY indicator will turn off and a message will show in the Multi-Information Display.

**Step 7** Check the status of the charging indicator.

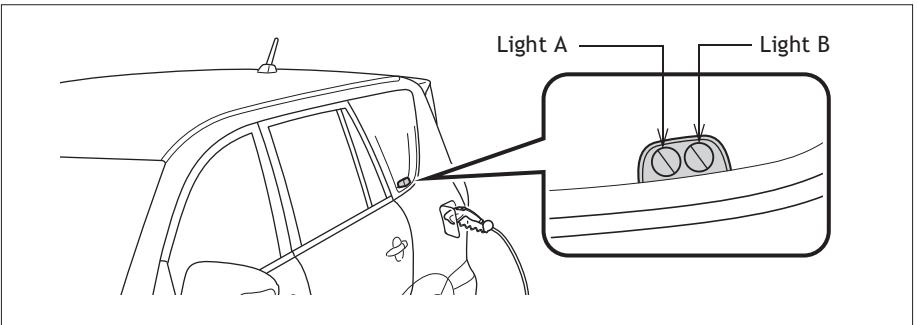

The charging indicator consists of two lights that display charging status by illuminating, flashing and turning off as follows:

Charging status	Charging indicator	
	Light A	Light B
Charging cable is connected to vehicle and the charging and/or Pre-climate schedule is set	Lights A and B flash on and off alternatively for 10 minutes (after 10 minutes, lights remain off until charging starts).	
Charge level is less than 49%	Flashes	Off
Charge level is between 50% and less than 99%	Illuminates	Flashes
Charging is complete	Both lights A and B illuminate for 10 minutes (after 10 minutes, both lights turn off).	
Malfunction occurred during charging	Both lights A and B quickly flash simultaneously for 10 seconds (after 10 seconds both lights turn off).	

The indicator lights will not flash or turn on if the charging cable is not connected properly. During charging, current charging status and the estimated time until charge completion can be checked on the Multi-Information Display or navigation display.

## Charging cable-Unplugging

Step 1 Pull the charging connector toward you while pressing the latch release button.

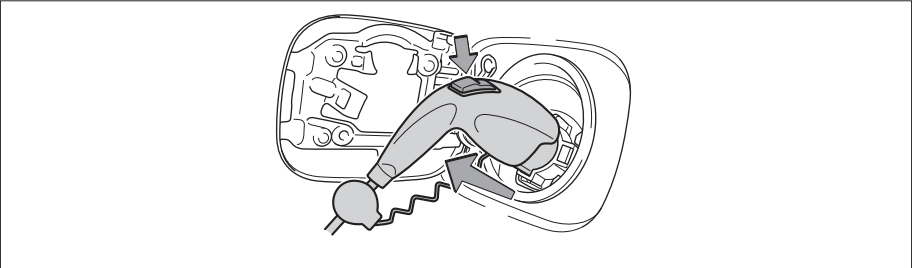

Step 2 Attach the charging connector cap.

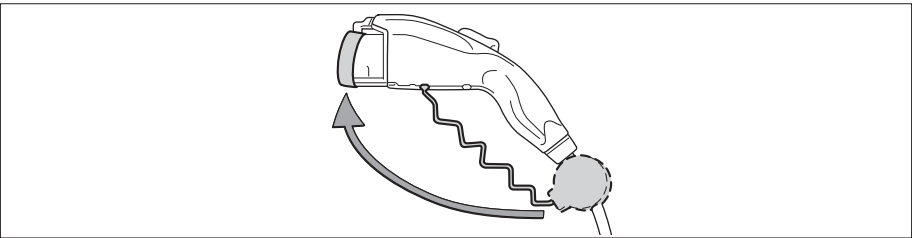

Step 3 Close the charging port cap, and then close the charging port door.

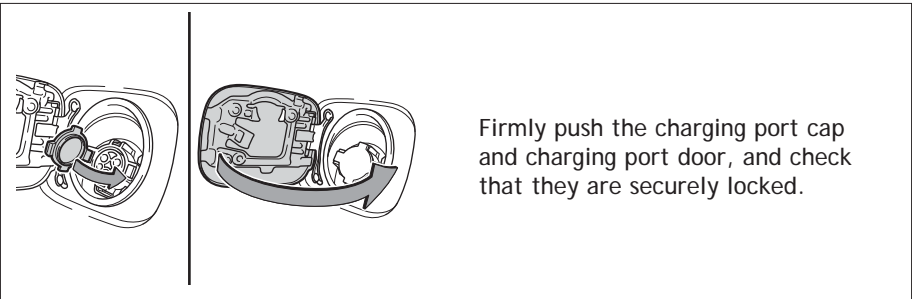

Firmly push the charging port cap and charging port door, and check that they are securely locked.

Step 4 Remove the plug from the electrical receptacle when the charging equipment will not be used for a long period of time.

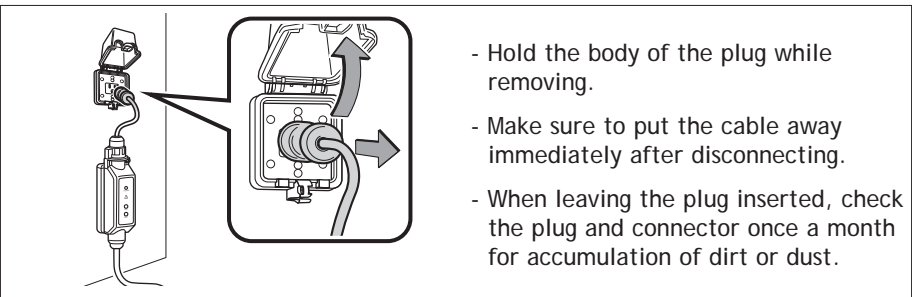

- Hold the body of the plug while removing.
- Make sure to put the cable away immediately after disconnecting.
- When leaving the plug inserted, check the plug and connector once a month for accumulation of dirt or dust.

## Charging

Depending on the charge settings, the vehicle may not start charging just by plugging in the charging cable. Use the navigation screen to set the charging and Pre-climate/remote climate control schedules. Before either function starts, it is recommended that:

- Parking brake is securely set with shift position in "P"
- All windows and doors are closed
- Engine hood is securely closed
- All lights are turned off

When the EV System is turned off, the screen changes to the charging and Pre-climate settings screen. If no operations are performed for approximately 30 seconds, the screen turns off.

### By My Departure schedule setting

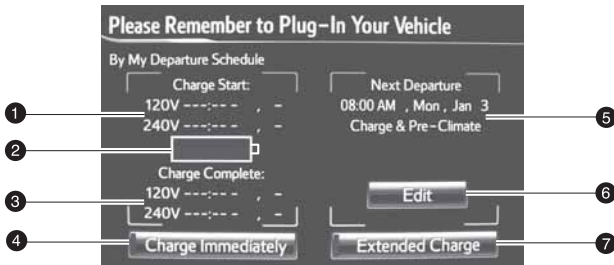

### Charge and Pre-climate schedule setting screen



- |                                       |                                 |
|---------------------------------------|---------------------------------|
| ① Next charge start schedule          | ⑧ Set departure time dial       |
| ② Battery charge amount               | ⑨ Charge Only button            |
| ③ Charge complete schedule            | ⑩ Pre-climate Only button       |
| ④ Charge immediately button           | ⑪ Charge and Pre-climate button |
| ⑤ Next departure schedule             | ⑫ Add/Delete button             |
| ⑥ Departure schedule Edit button      |                                 |
| ⑦ Extended charge mode setting button |                                 |

# ELECTRIC VEHICLE SYSTEM

## Pre-climate (Remote Climate Control)

Adjusting cabin temperature before driving reduces traction battery consumption after departure, thereby increasing driving range. If the amount of charge remaining in the traction battery is less than 50% at the time Pre-climate operation is scheduled to begin, Pre-climate operations will not be performed in order to preserve driving range.

The climate control system can be turned on before entering the vehicle by setting the Pre-climate schedule or using the Smartphone Entune® EV Remote Climate application on a smartphone.

Pre-climate operations completion can be set for a specific time on each day of the week.

## Charging settings

The RAV4 EV may be charged immediately, or scheduled to charge at a specific time each day.

System	Details
Charging	<b>Charge immediately</b> Starts charging immediately regardless of charging schedule settings.
	<b>Scheduled charging</b> Charge completion can be set for a specific time on each day of the week. If no schedule is set, the system defaults to the Charge Immediately function.

## Smartphone Entune® EV Applications

Drivers with a smartphone and active Entune® and Safety Connect® subscriptions may remotely interact with several features of the RAV4 EV.

For details, please refer to <http://www.toyota.com/entune> or call 1-800-331-4331.

## Charge Immediately

Depending on the charge settings, the vehicle may not automatically start charging upon plug-in. You may set it to Charge Immediately in one of two ways. This setting will temporarily override any schedule that may already be set.

### Start Charge Immediately

**Step 1** Turn the EV System off. The charge settings screen will be displayed. If no actions are performed, screen will turn off after 30 seconds.

**Step 2** Touch “Charge Immediately.”



After operations have been completed, the “Charge Immediately” screen button indicator illuminates.

**Step 3** Plug in the charging cable. Charging will start.

### Preset Charge Immediately

**Step 1** Touch EV on the Main Menu.

**Step 2** Touch “Charging & Pre-climate Setup.”

**Step 3** Touch  to display the “Charge Immediately on Plug-in” screen. Touch “Save.”



**Step 4** A screen advising that charge mode has been changed to Charge Immediately is displayed. The EV screen returns after a few seconds.

**Step 5** Turn the EV System off. The charge settings screen will be displayed for about 30 seconds.

**Step 6** Plug in the charging cable. Charging will start.

# ELECTRIC VEHICLE SYSTEM

## Scheduled charging

Charging and Pre-climate operations may be programmed to complete at a specific time on any or all days of the week.

### Set charging/Pre-climate schedule

Step 1 Touch EV.

Step 2 Touch "Charging & Pre-climate Setup."

Step 3 Touch  to display the "My Departure Schedule" screen. Touch "Schedule Setup."

Step 4 Touch desired day.



Step 5 Flick the schedule to the desired time for charging and/or Pre-climate completion. Select Charge Only, Pre-climate Only or Charge & Pre-climate.



- Up to three actions can be set for a single day by touching "Add."
- To delete the set action, touch "Delete."
- Two actions cannot be set at the same time.

Step 6 After settings have been completed, touch  twice to return to the "By My Departure Schedule."



Step 7 Touch "Save." If "Save" is not touched, the changes will not be reflected in the charging schedule.



**Step 8** *When charging schedule is only set for some days of the week:*

If “Keep My Schedule” is touched, setting the charging schedule is done and the EV screen returns. Touch “Return to Schedule Setup” to set the charging schedule for additional days.



**Step 9** *When charging schedule is set for each day of the week:*

A screen advising that settings have been completed appears. The EV screen returns after a few seconds.

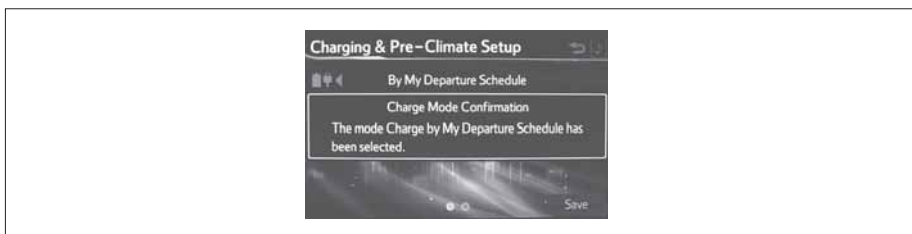

# ELECTRIC VEHICLE SYSTEM

## Add a one-time departure

**Step 1** Turn the EV System off. If a charge schedule has been previously set, the following charge settings screen will be displayed. If no actions are performed, screen will turn off after 30 seconds.

**Step 2** Touch "Edit."

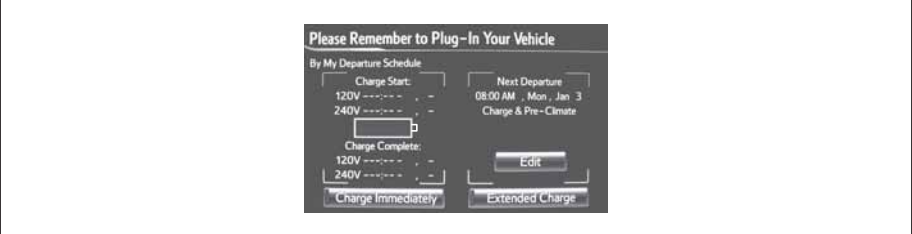

**Step 3** Touch "Yes."

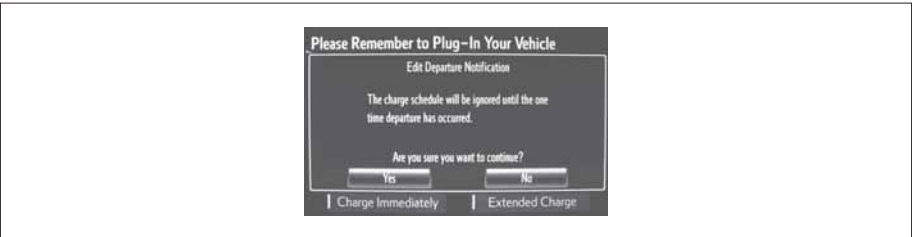

**Step 4** Flick the schedule to the desired day and time for charging and/or Pre-climate completion. Select Charge Only, Pre-climate Only or Charge & Pre-climate. Touch Save.

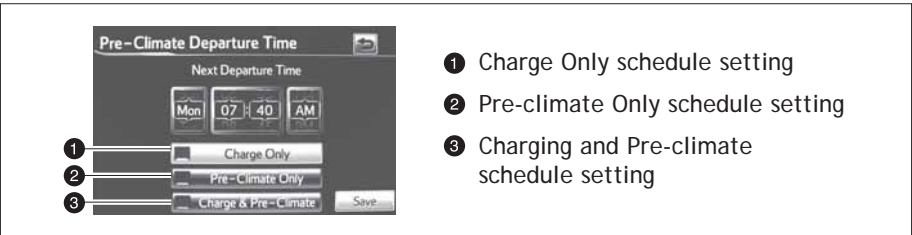

**Step 5** The set schedule will be displayed. To change the set action or schedule, return to Step 2.

**Step 6** Plug in the charging cable.

## Extended charge mode

### Charge modes

The RAV4 EV has two charge modes which can be selected depending on your intended usage.

Charge mode	Charge amount*	Details
Normal charge mode	Approx. 80%	Maximizes traction battery life. Recommended whenever long distance driving is not necessary.
Extended charge mode	Approx. 100%	Maximizes driving range on a single charge. However, frequent use of this mode may shorten traction battery life.

\* An approximation based on a traction battery without any capacity deterioration. This value will fluctuate depending on conditions such as air conditioning system usage, road conditions, years of usage, etc.

### Changing to extended charge mode

**Step 1** Turn the EV System off. The screen will change to the charging schedule screen. The screen will turn off after about 30 seconds if no operations are performed. Depending on “Charging & Pre-climate Setup” settings, the displayed screen will differ.

**Step 2** Touch “Extended Charge.”



# ELECTRIC VEHICLE SYSTEM

Step 3 Read screen and touch “YES” to continue to Extended Charge mode. Touching “NO” will cause previous screen to return.

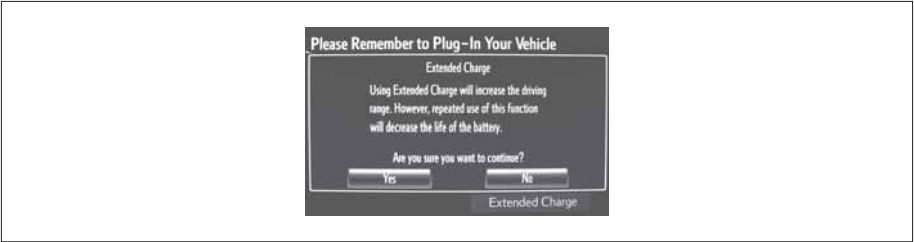

Step 4 When settings are completed, the “Extended Charge” screen button indicator illuminates. Touching “NO” will cause previous screen to return.

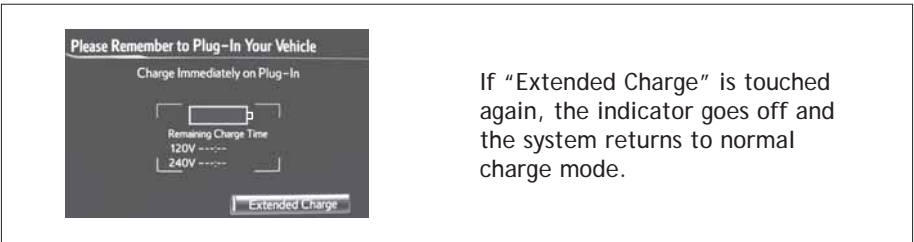

NOTE: The charge mode will remain on the last mode selected (either extended or normal) and default to that mode the next time the vehicle is charged.

## Multi-Information Display-Charging information

Charging and Pre-climate results While charging/Pre-climate operations are being performed or after they are finished, the following information is displayed for 30 seconds when the driver's door is opened.

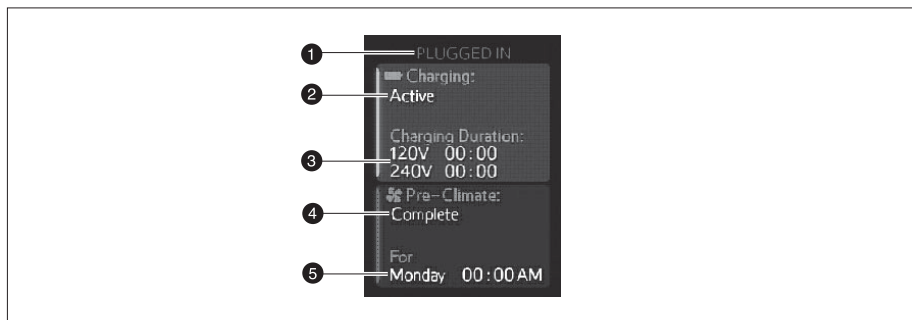

- ❶ Plug connection status
- ❷ Current charging status
- ❸ Estimated charging time (both 120V and 240V)

When the plug is connected, only the voltage of the connected receptacle is displayed.

- ❹ Pre-climate status
- ❺ Departure time\*

\* If Pre-climate operations are performed using a smartphone, this will not be displayed even if the driver's door is opened.

In the following conditions, only the plug connection information will be displayed:

- When the POWER switch is turned to ON mode after charging/Pre-climate operations.
- When the charging/Pre-climate schedule is not set.

**Note:** If Pre-climate operations are performed using a smartphone, Pre-climate results will be displayed.

**Charging information and warning messages** The first time the POWER switch is turned to ON mode after charging is completed, a message detailing the results of the charge is shown. Also, if an operation that cannot be carried out during charging was attempted, a warning message will be shown.



## Confirming charge settings

The amount of charge remaining in the traction battery and charging/Pre-climate schedule settings can be confirmed, and the schedule can be adjusted according to your next departure time.

**Step 1** Touch EV.

**Step 2** Touch "Charge Summary."

The next scheduled charge (if previously set) will also be shown on this screen. If an earlier charge time is desired, a one-time departure may be scheduled here.

**Step 3** Touch "Edit."

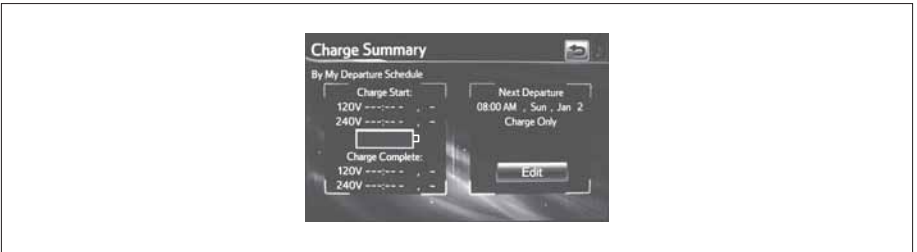

**Step 4** Touch "Yes."

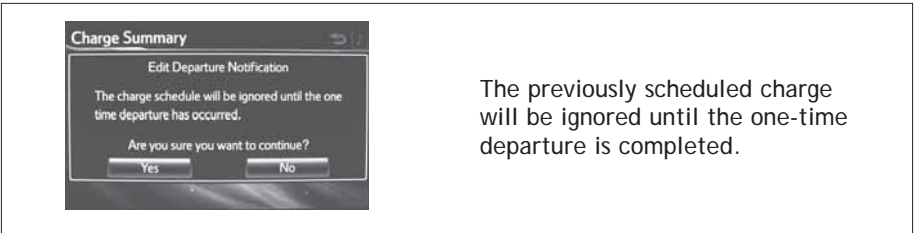

The previously scheduled charge will be ignored until the one-time departure is completed.

For details on setting one-time departure, see Charging section.

## Inspecting electrical leakage detection function

In the unlikely event that the electrical leakage detection function is not operating properly, contact your Toyota dealer as soon as possible. Check that it is operating properly by following the procedure below.

**Step 1** Insert the charging cable into the electrical receptacle of the external power source.

**Step 2** Press the test button on the CCID (Charging Circuit Interrupting Device).

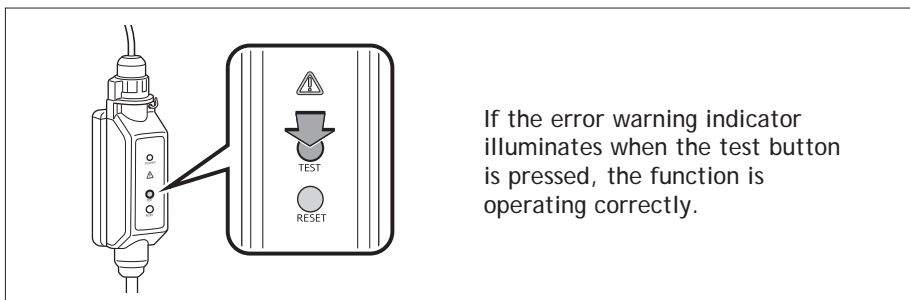

If the error warning indicator illuminates when the test button is pressed, the function is operating correctly.

**Step 3** Press the reset button on the CCID (Charging Circuit Interrupting Device).

Turn off the error warning indicator. Charging cannot be carried out while the error warning indicator is illuminated.

Charging can be continued by following the normal procedure. Store the charging cable when not in use.

See the *Owner's Manual* for important precautionary information.

# FEATURES/OPERATIONS

## Transmission

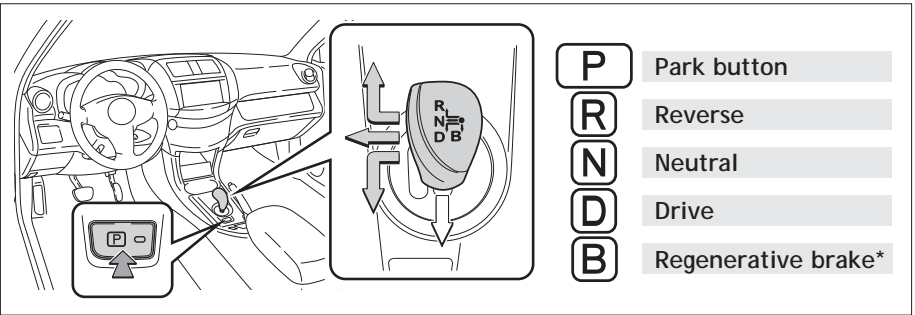

\* The regenerative brake is the equivalent of downshifting. Shift to “B” when regenerative braking is desired (i.e. downhill driving, coasting to a stop, etc.).

## SPORT Mode

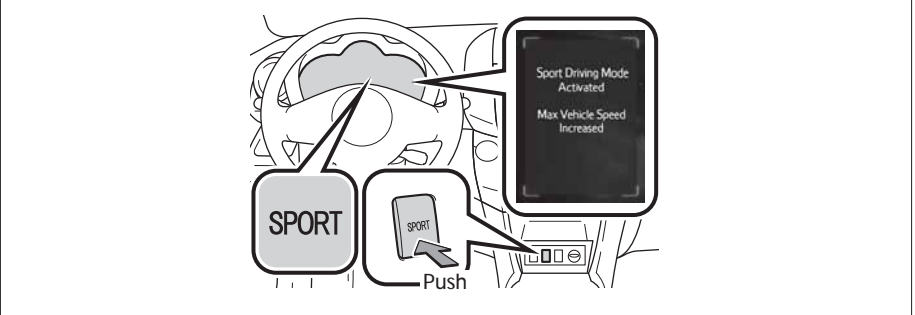

By increasing the motor's output when compared to normal mode, the vehicle's acceleration power and maximum speed is increased. This mode provides a more dynamic driving experience.

Refer to the *Owner's Manual* for more details.

## Parking brake

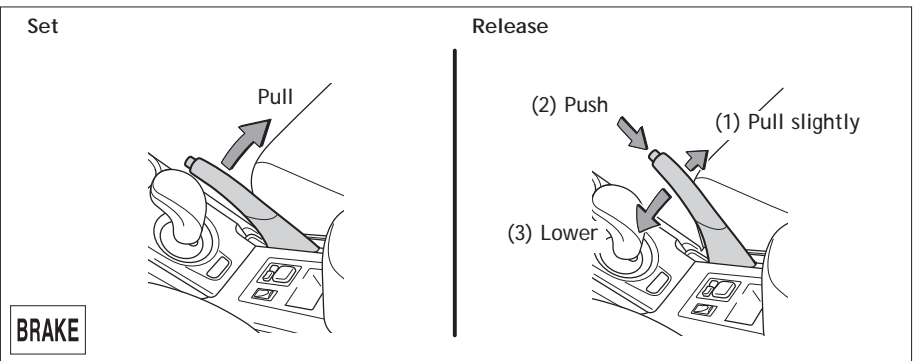



## Seat adjustments-Front

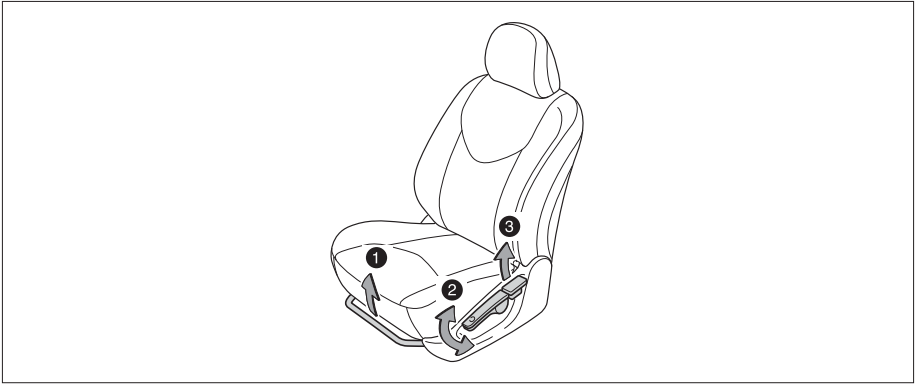

- ❶ Seat position (forward/backward)
- ❷ Height crank (driver side only)
- ❸ Seatback angle

## Seat adjustments-Rear



- ❶ Seat position (forward/backward)
- ❷ Seatback angle

### Seats-Head restraints

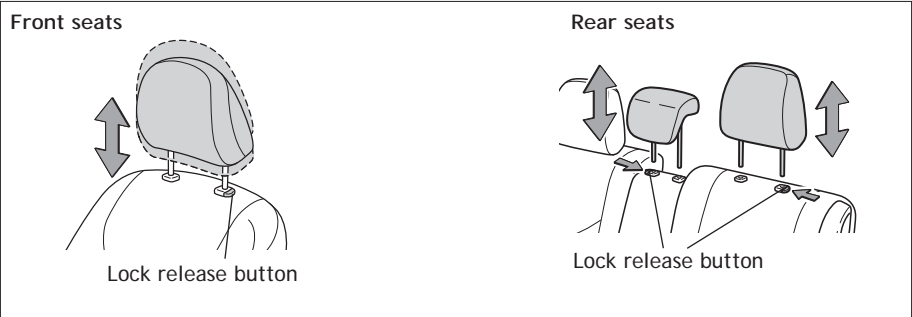

### Seats-Folding down rear seats

#### From inside

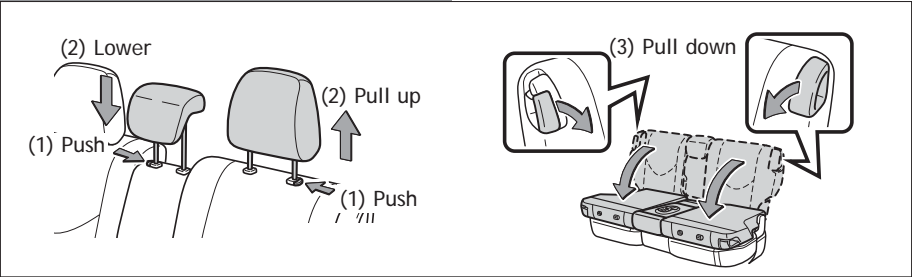

#### From outside

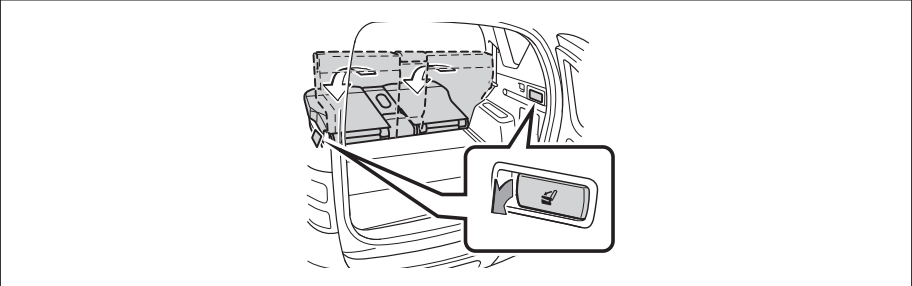

## Lights & turn signals

### Headlights

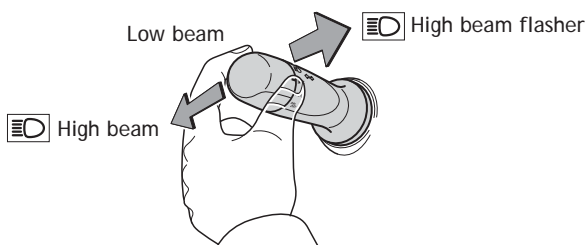
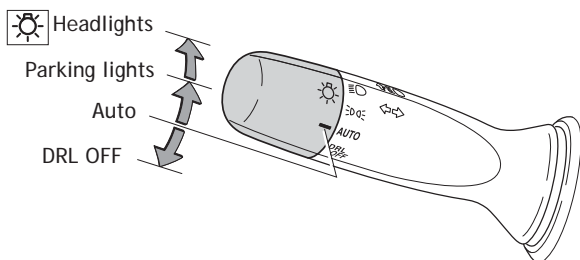

#### -Daytime Running Light system (DRL)

Automatically turns on the Daytime Running Lights after EV System is started and parking brake released.

-Automatic light cut off system Automatically turns lights off after a delay of 30 seconds, or the lock switch on remote may be pushed after locking.

### Turn signals

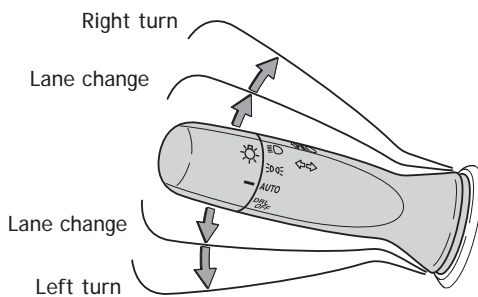

## Windshield wipers & washers

### Front

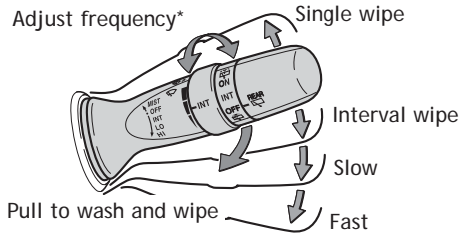

\* Intermittent windshield wiper frequency adjustment Rotate to increase/decrease wipe frequency.

### Rear

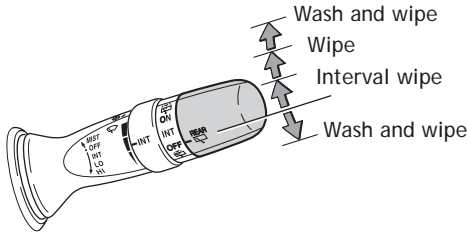

## Windows-Power

### Driver side

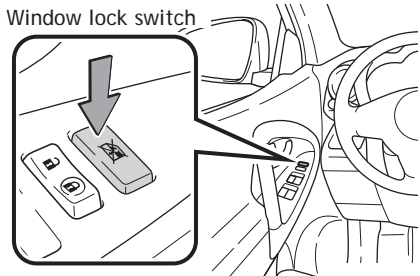
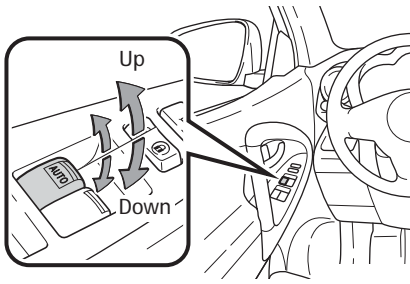

**Automatic operation (driver side only)** Push the switch completely down or pull it completely up and release to fully open or close. To stop the window partway, operate the switch in the opposite direction.

**Window lock switch** Deactivates all passenger windows. Driver's window remains operable.

## Door locks

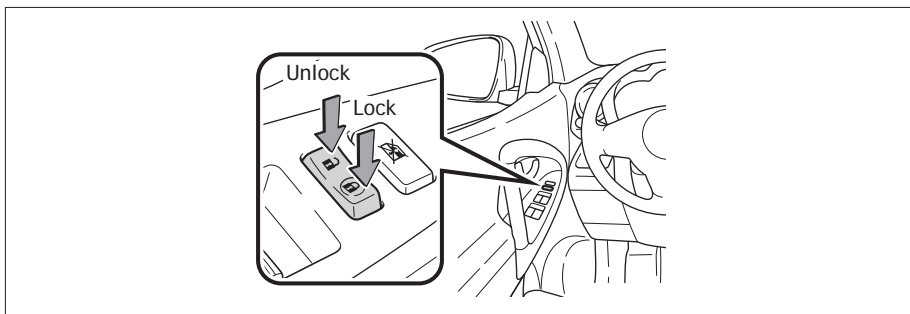

## Light control-Instrument panel

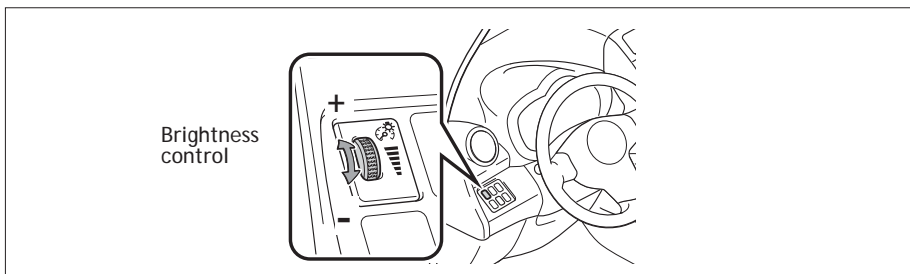

With the dial turned fully up, instrument panel lights will not dim when the headlights are turned ON.

## Telephone controls (Bluetooth®)

Navigation system screen



Start call/End call

Microphone



Steering wheel telephone switches

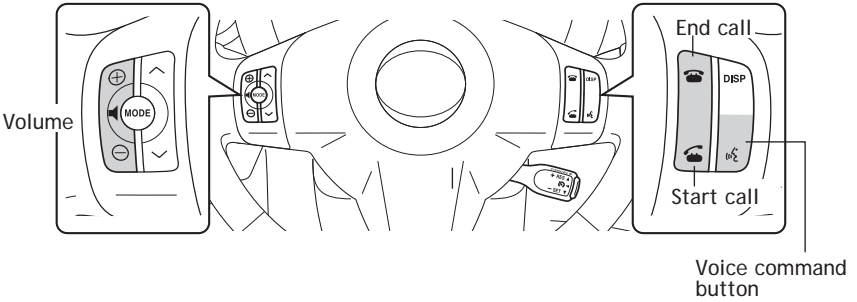

Bluetooth® technology allows dialing or receipt of calls without taking hands from the steering wheel or using a cable to connect the compatible telephone and the system.

Refer to "Navigation System Owner's Manual" for more information about phone connections and compatibility.

## Seat heaters

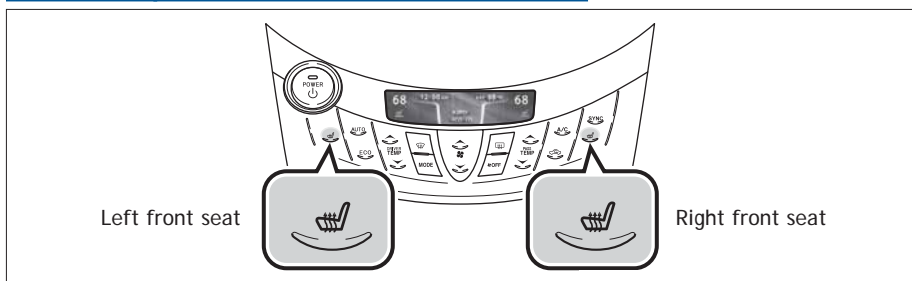

## Air Conditioning/Heating

### Automatic Air Conditioning

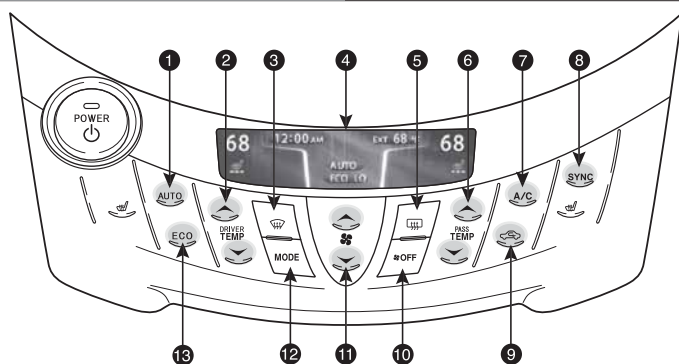

- 1 Automatic climate control ON  
Adjust the temperature setting, and airflow vents and fan will adjust automatically.
- 2 Temperature selector (driver side)
- 3 Windshield defogger
- 4 HVAC display
- 5 Rear defogger
- 6 Temperature selector (front passenger side)
- 7 Air Conditioning ON/OFF
- 8 "SYNC" button  
ON: Separate temperature settings for driver and passenger.  
OFF: Synchronize temperature settings for driver and passenger.
- 9 Recirculate cabin air (fresh air when OFF)
- 10 Climate control OFF
- 11 Fan speed
- 12 Airflow vent  
In "ECO" mode, use fresh air ("ECO" indicator OFF) to reduce window fogging.  
"ECO" mode uses fresh air only.
- 13 ECO mode selector

Refer to the *Owner's Manual* for more details.

## Clock

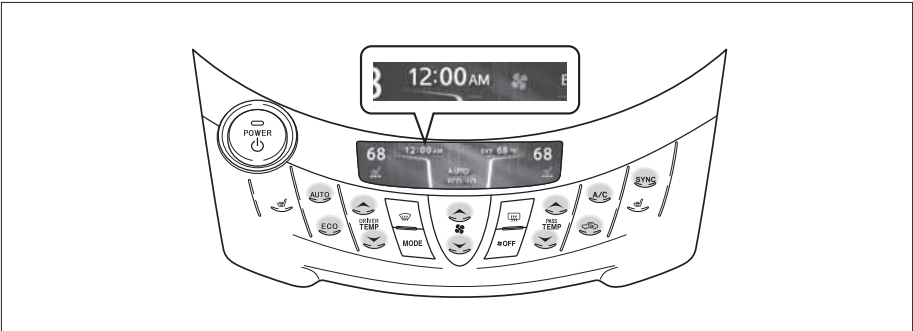

The time settings can be changed on the navigation system.

Refer to the *Navigation System Owner's Manual* for more details.

## Navigation System

### Screen operations

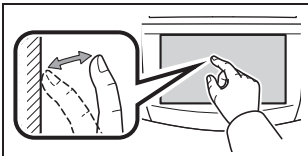

**Touch**  
Changing and selecting various settings.

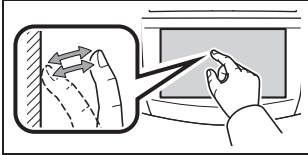

**Double tap**  
Changing the map scale.

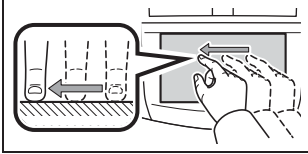

**Drag**  
Moving around the map, adjusting audio volume, etc.

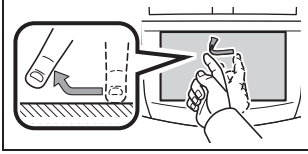

**Flick**  
Moving around the map, skipping to the next page of a list, etc.



## Functions

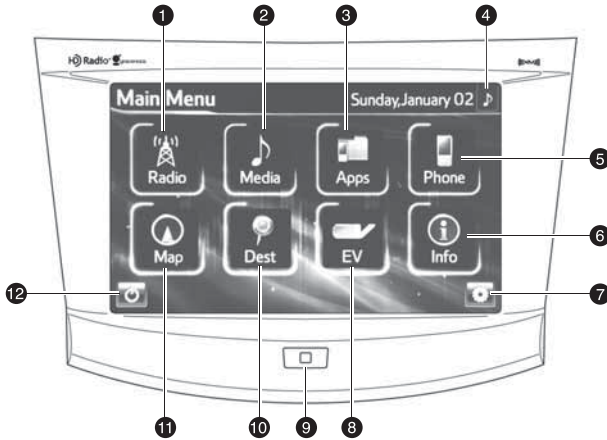

- ① Touch to display the radio control screen.
- ② Touch to display the media control screen.
- ③ Touch to display the "Apps" screen.
- ④ Touch to display the audio control screen.
- ⑤ Touch to display the hands-free operation screen.
- ⑥ Touch to display the "Information" screen.
- ⑦ Touch to display the "Setup" screen.
- ⑧ Touch to view and set Energy Monitor, Charge Summary, Charging & Pre-climate Setup and Range Map settings. For details, refer to the *Owner's Manual*.
- ⑨ Press to display the "Main Menu" screen. Press and hold to turn off the screen and audio system.
- ⑩ Touch to display the "Destination" screen.
- ⑪ Touch to display the current position and start guidance.
- ⑫ Touch to turn the audio system on and off.

Refer to the *Navigation System Owner's Manual* for instructions and more information.

## Steering wheel switches

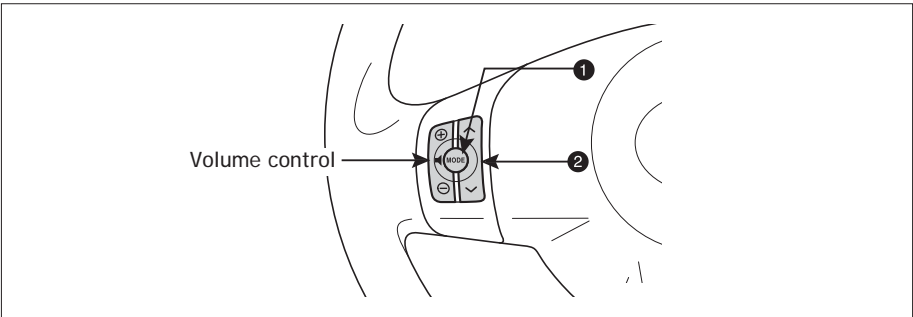

- 1 "MODE"  
Push to turn audio ON and select an audio mode. Push and hold to mute or pause the current operation.
- 2 " ^ v "  
Use to search within the selected audio medium (radio, USB, iPod®, etc.).

## iPod®/USB/AUX port

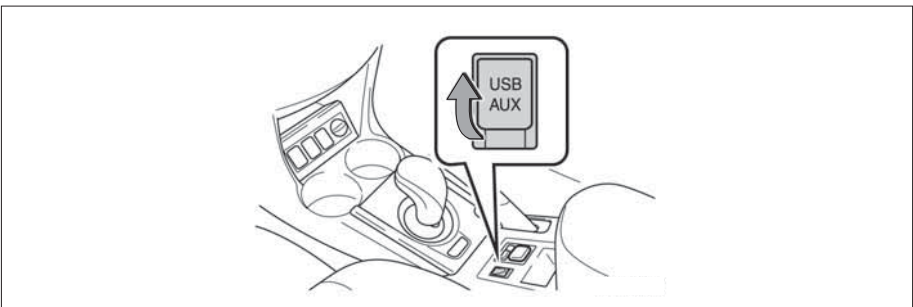

**iPod®/USB port**  
By connecting a USB-compatible portable audio device or USB memory to the USB port, you can listen to music from the portable audio device or USB memory through the vehicle's speaker system.

**AUX port**  
By inserting a mini plug into the AUX port, you can listen to music from a portable audio device through the vehicle's speaker system while in AUX mode.

## Tilt and telescopic steering wheel

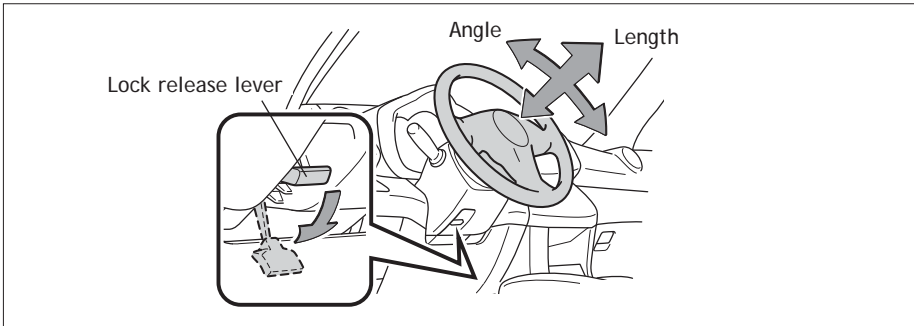

Hold wheel, push lever down, set angle and length, and return lever.

**NOTE:** Do not attempt to adjust while the vehicle is in motion.

## Cruise control

### Turning system ON/OFF

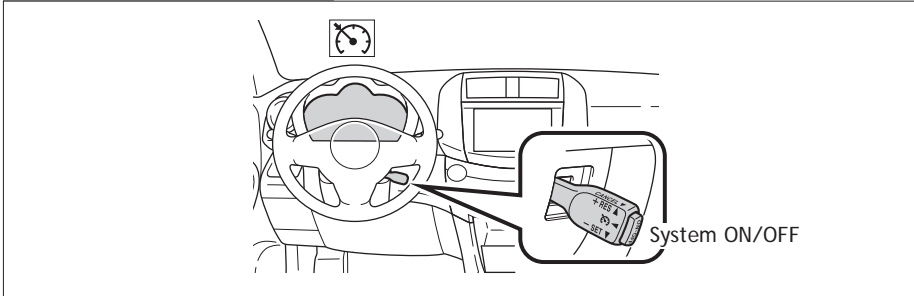

### Functions

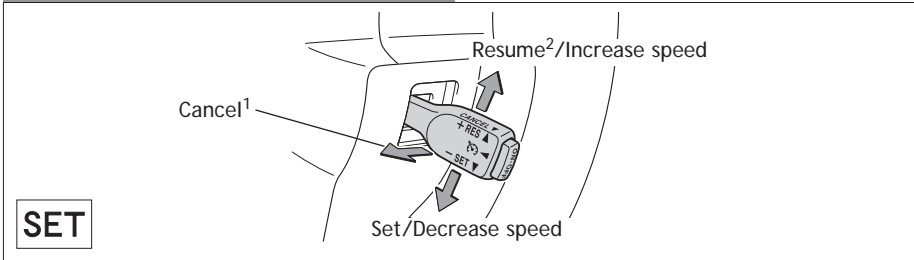

<sup>1</sup> The set speed may also be cancelled by depressing the brake pedal.

<sup>2</sup> The set speed may be resumed once vehicle speed exceeds 25 mph.

Refer to the *Owner's Manual* for more details.

**Multi-Information Display**

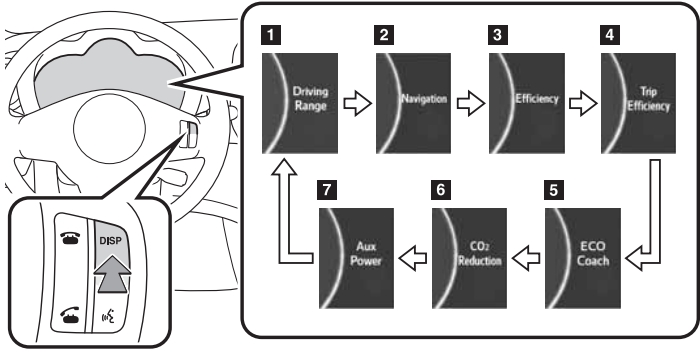

Push “DISP” to change between the following information screens:

- (1) Driving range
- (2) Turn-by-turn navigation
- (3) Efficiency
- (4) Trip efficiency
- (5) ECO coach
- (6) CO<sub>2</sub> reduction
- (7) AUX power

**Power outlets-12V DC**

Instrument panel

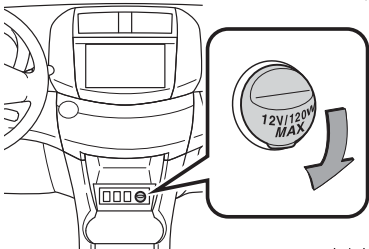

Inside center console

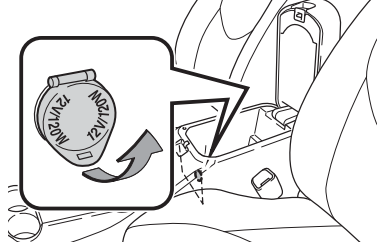

Luggage compartment

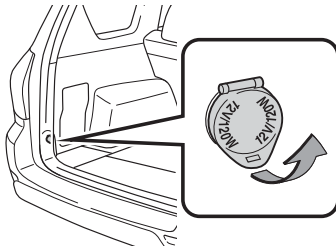

**NOTE:** Designed for car accessories. Power switch must be in the “ACCESSORY” or “ON” mode to be used.

## Hill-start Assist Control (HAC)

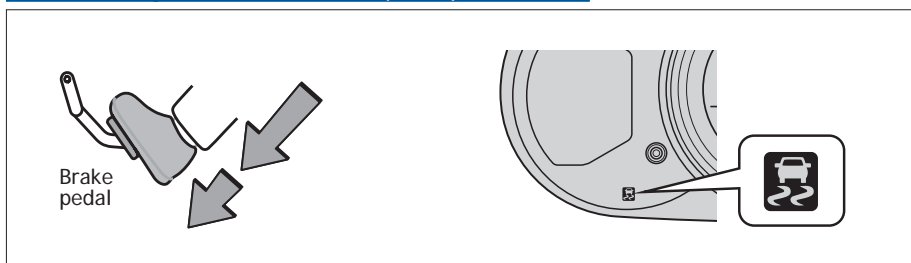

HAC helps prevent rolling backwards on an incline. To engage, push further down on brake pedal while at a complete stop until a beep sounds and slip indicator illuminates. HAC holds for approximately two seconds after releasing brake pedal. Refer to the *Owner's Manual* for more details.

## VSC OFF button

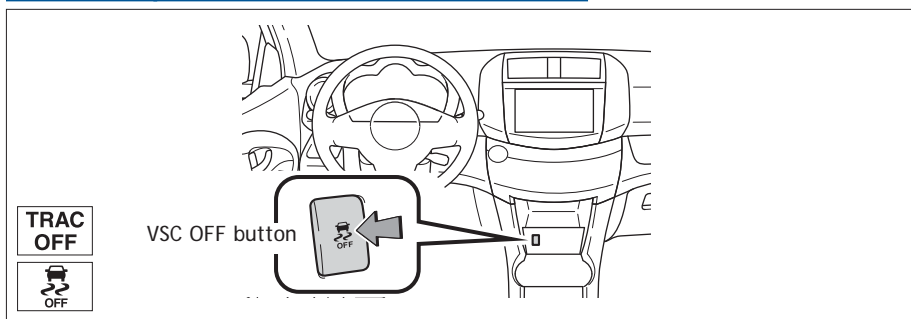

The VSC OFF button is used to switch between modes related to the TRAC and VSC functions.

Refer to Section 2-4 of the *Owner's Manual* for more information.

# SAFETY AND EMERGENCY FEATURES

## Doors-Child safety locks

Rear door



Moving the lever downward will allow the door to be opened only from the outside.

## Seat belts

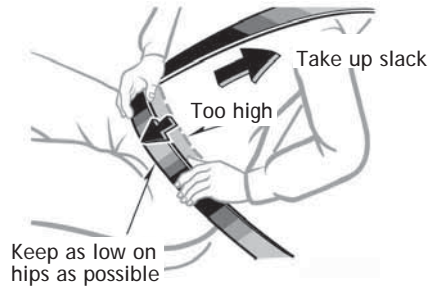
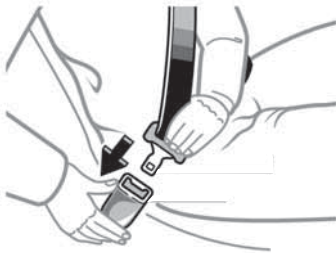

If belt is fully extended, then retracted even slightly, it cannot be re-extended beyond that point, unless fully retracted again. This feature is used to help hold child restraint systems securely.

To find more information about seat belts, and how to install a child restraint system, refer to the *Owner's Manual*.

## Seat belts-Shoulder belt anchor

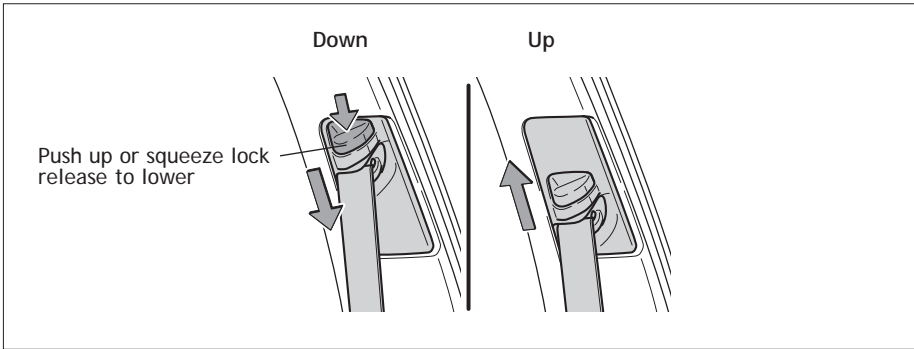

## Tire Pressure Monitoring (warning) System

If tire pressure becomes critically low on any of the tires, “” indicator will come on. Correctly adjusting tire inflation will turn off the light after a few minutes. If the light does not turn off, have the system checked by your Toyota dealer.

Refer to the *Owner's Manual* for more details.

## Emergency tire puncture repair kit

### Tool location

Luggage compartment inside right side box

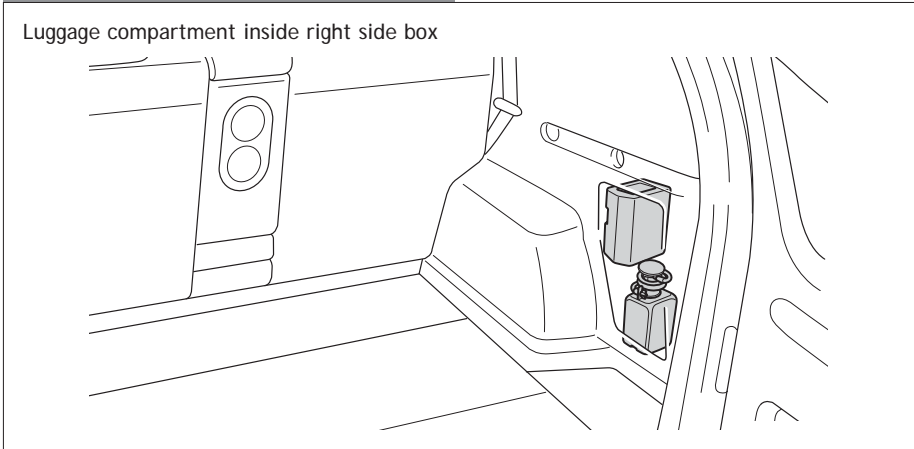

Refer to the *Owner's Manual* for more details.

## SAFETY AND EMERGENCY FEATURES

### Star Safety System™

All new Toyota vehicles come standard with the Star Safety System™, which combines Vehicle Stability Control (VSC), Traction Control (TRAC), Anti-lock Braking System (ABS), Electronic Brake-force Distribution (EBD), Brake Assist (BA) and Smart Stop Technology (SST).

#### Vehicle Stability Control (VSC)

VSC helps prevent loss of traction during cornering by reducing power from the EV System and applying brake force to selected wheels.

Toyota's VSC monitors steering angle and the direction your vehicle is traveling. When it senses that the front or rear wheels begin to lose traction, VSC reduces power from the EV System and applies braking to selected wheels. This helps restore traction and vehicle control.

#### Traction Control (TRAC)

VSC helps prevent loss of traction during cornering by reducing power from the EV System, and Traction Control helps maintain traction on loose gravel and wet, icy, or uneven surfaces by applying brake force to the spinning wheel(s).

Toyota's TRAC sensors are activated when one of the drive wheels starts to slip. TRAC limits motor output and applies the brakes to the spinning wheel. This transfers power to the wheels that still have traction to help keep you on track.

#### Anti-Lock Brake System (ABS)

ABS helps prevent brakes from locking up by "pulsing" brake pressure to each wheel. This limits brake lockup and helps provide directional control for the current road conditions.

Toyota's ABS sensors detect which wheels are locking up and limits wheel lockup by "pulsing" each wheel's brakes independently. Pulsing releases brake pressure repeatedly for fractions of a second. This helps the tires attain the traction that current road conditions will allow, helping you to stay in directional control.

#### Electronic Brake Force Distribution (EBD)

Toyota's ABS technology has Electronic Brake-force Distribution (EBD) to help maintain control and balance when braking. Abrupt stops can cause a vehicle to tilt forward, reducing the braking power of the rear wheels. EBD responds to sudden stops by redistributing brake force to enhance the braking effectiveness of all four wheels.

#### Brake Assist (BA)

Brake Assist is designed to detect sudden or "panic" braking, and then add braking pressure to help decrease the vehicle's stopping distance. When there's only a split second to react, Brake Assist can add additional brake pressure more quickly than just the driver alone can.



## Smart Stop Technology (SST)

Smart Stop Technology automatically reduces driving torque when the accelerator and brake pedals are pressed simultaneously.

SST engages when the accelerator is depressed first and the brakes are applied firmly for longer than one-half second at speeds greater than five miles per hour.

SST doesn't engage if the brake pedal is depressed before the accelerator pedal, allowing vehicles to start on a steep hill and safely accelerate without rolling backward.

## Floor mat installation

There are two types of Toyota floor mats: carpeted and all-weather. Each vehicle has model-specific floor mats. Installation is easy.

To keep your floor mat properly positioned, follow these steps:

- Only use floor mats designed for your specific model.
- Use only one floor mat at a time, using the retaining hooks to keep the mat in place.
- Install floor mats right side up.

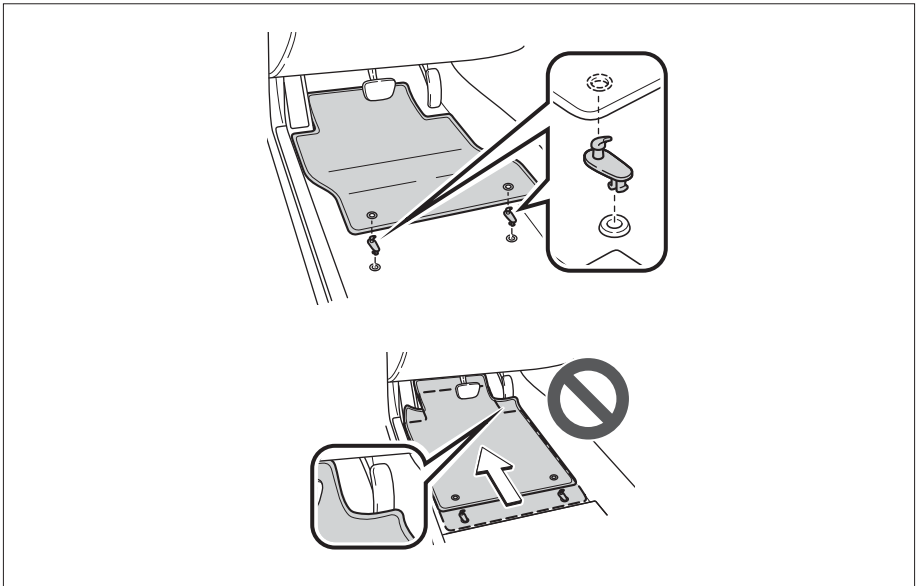

## NOTES





CUSTOMER EXPERIENCE CENTER  
1-800-331-4331

