

Cooling Fan <2GR-FE>

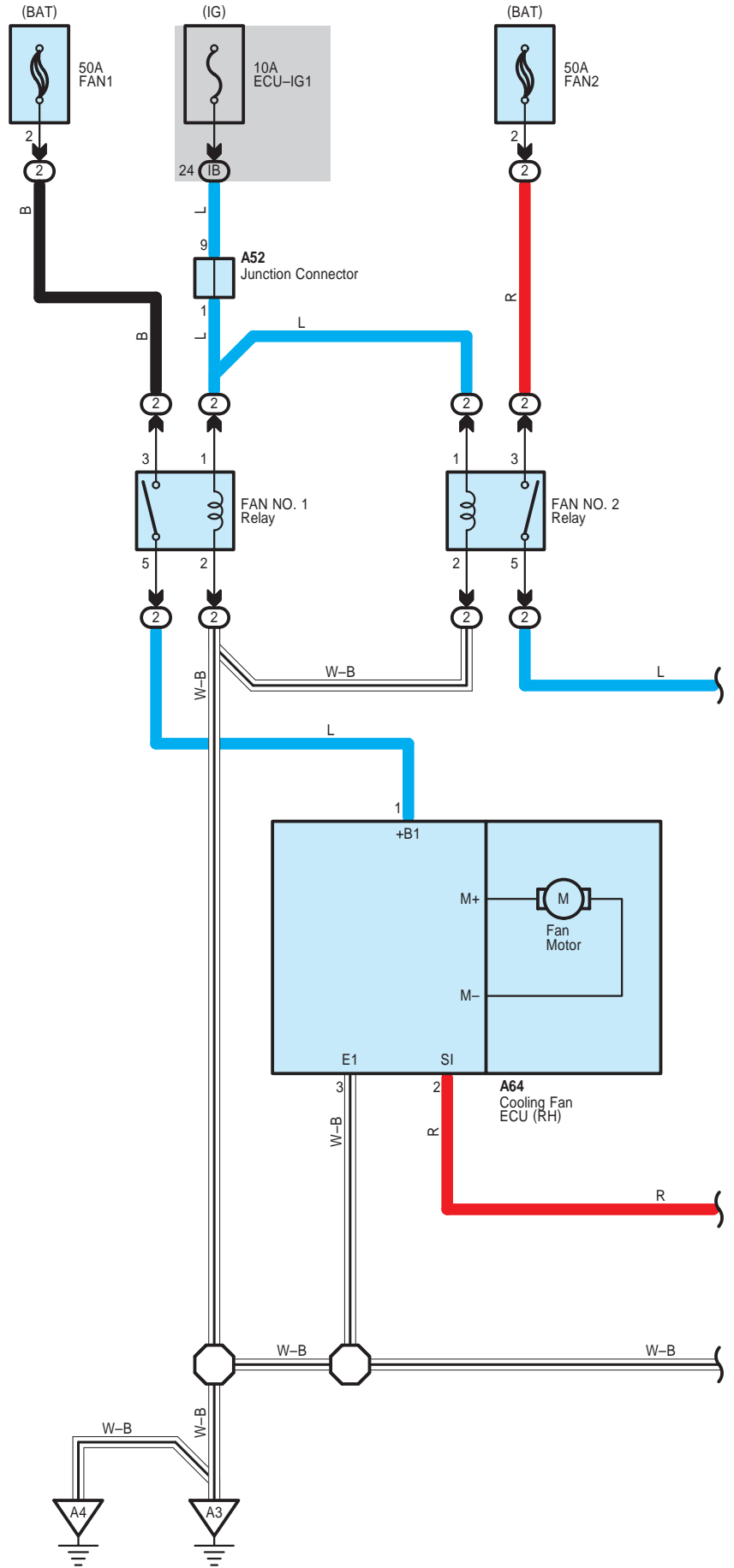

Cooling Fan <2GR-FE>

- * 3 : Shielded
- * 4 : Before Aug. 2008 Production
- * 5 : From Aug. 2008 Production

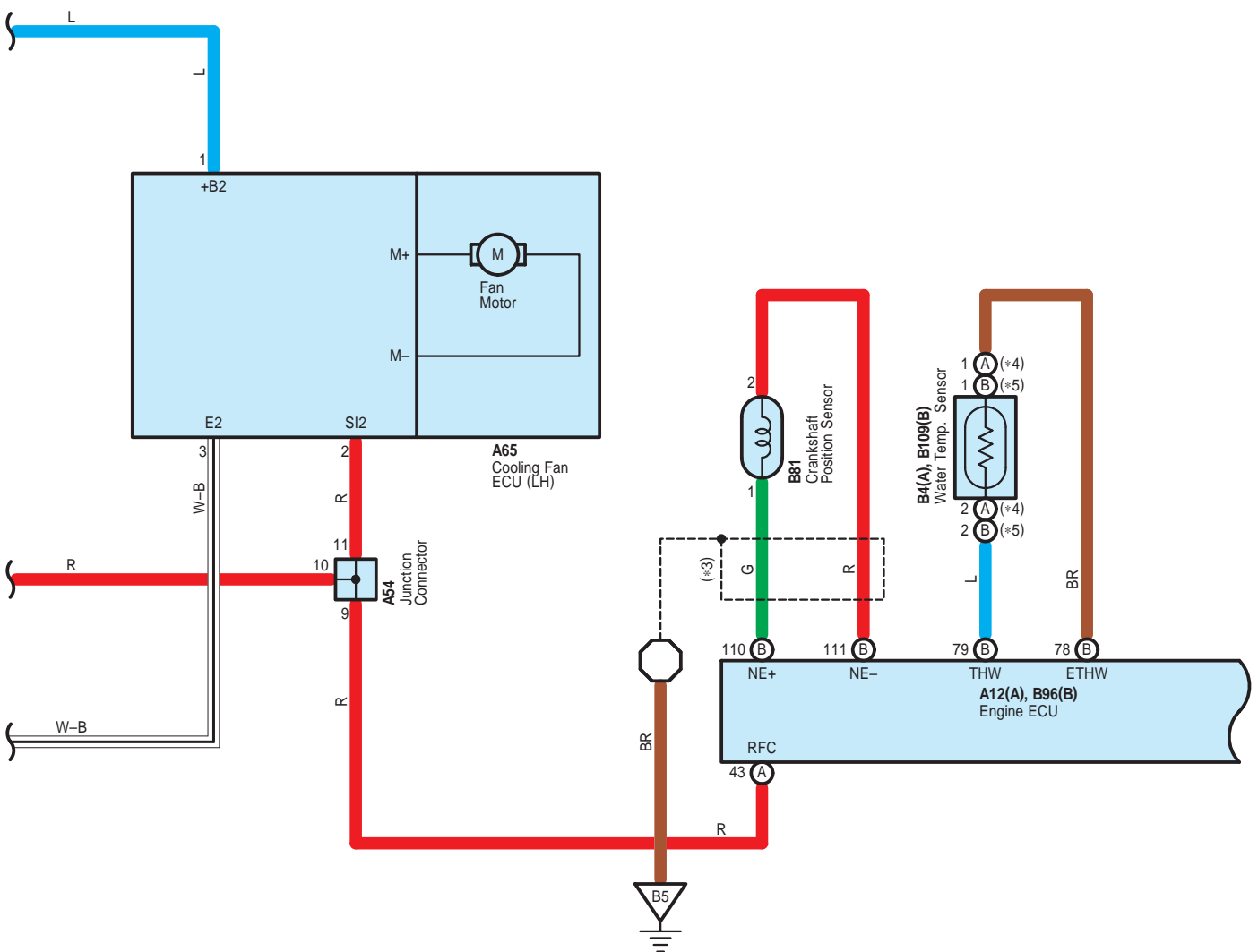

Cooling Fan <2GR-FE>

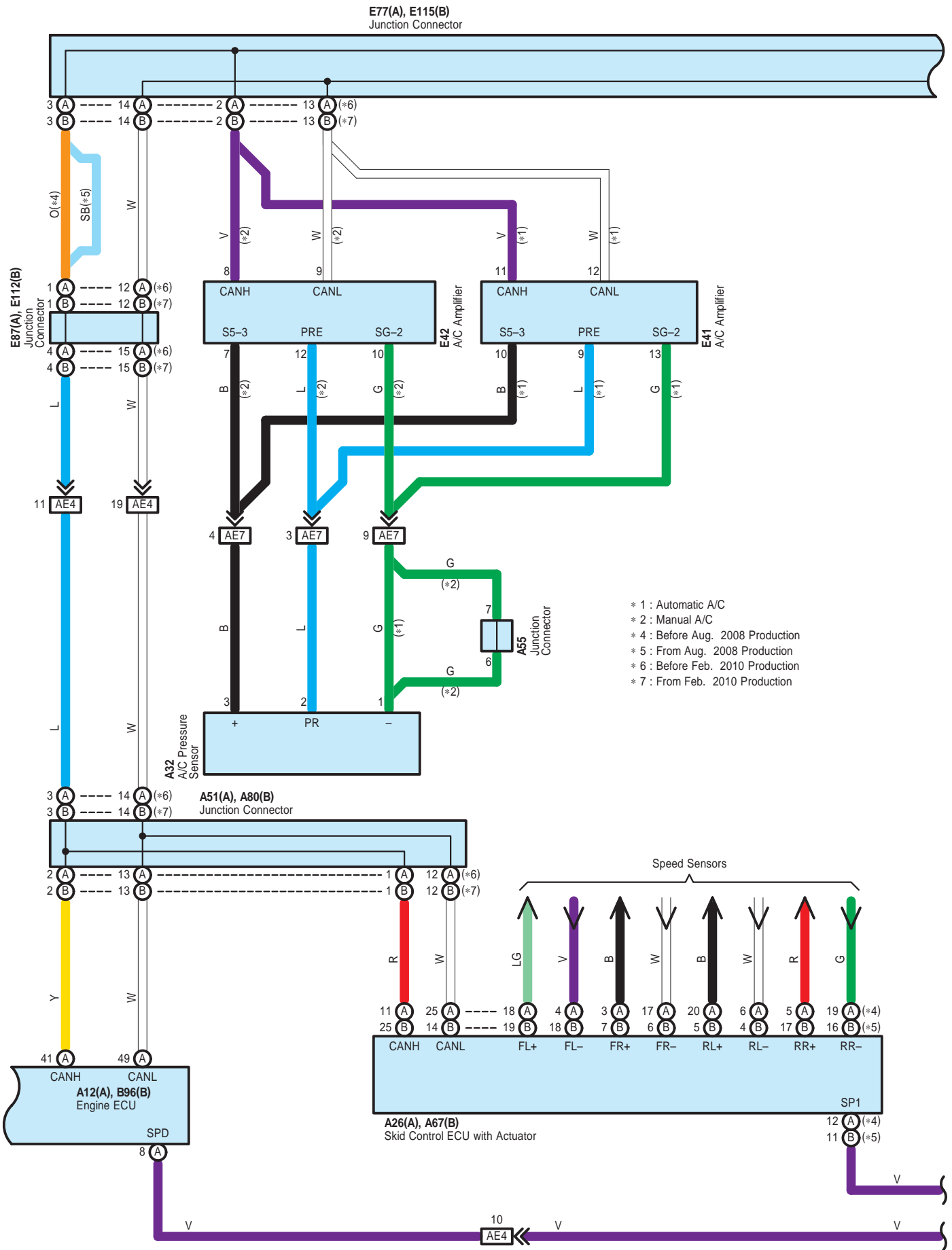

Cooling Fan <2GR-FE>

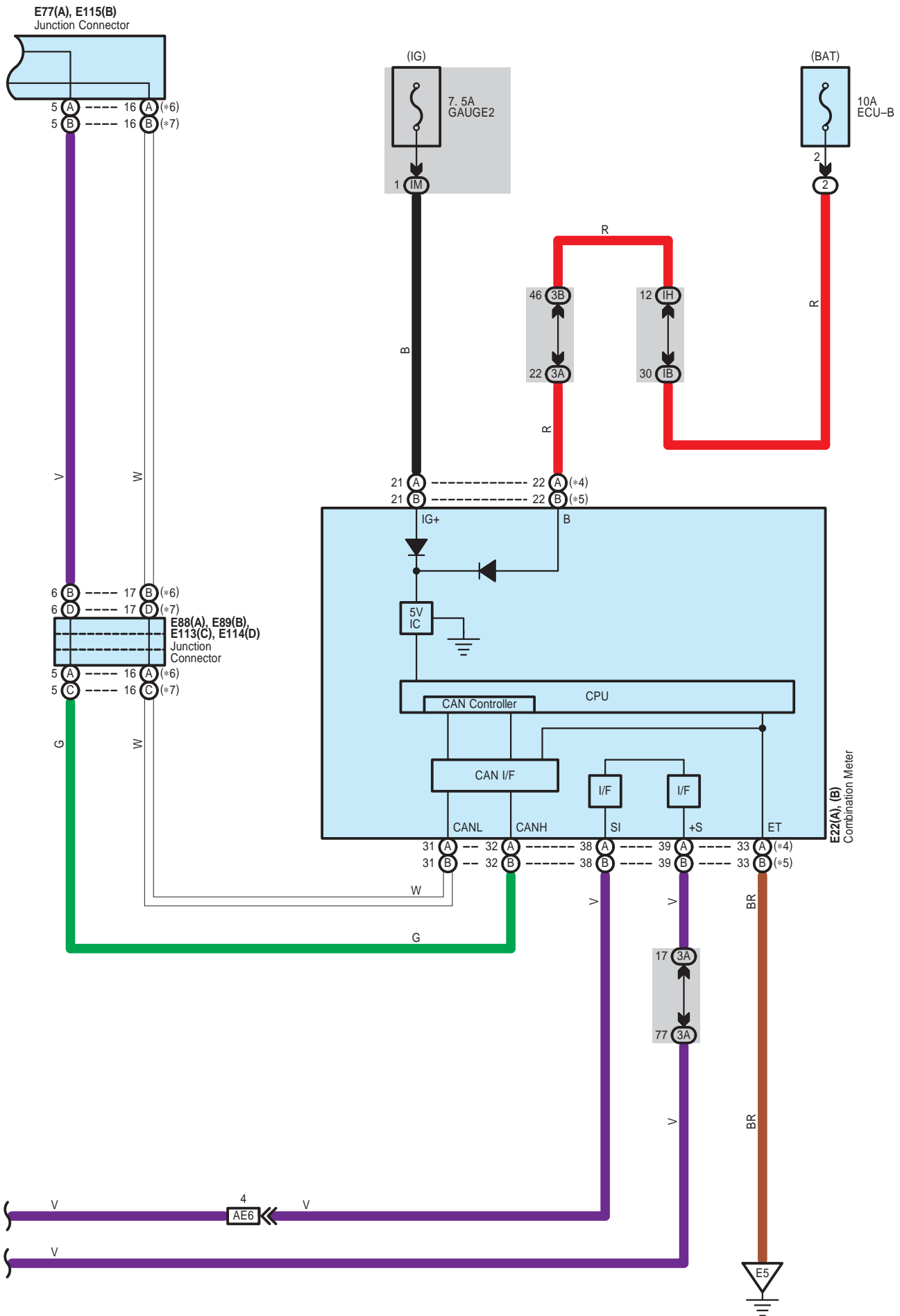

A 12
Black

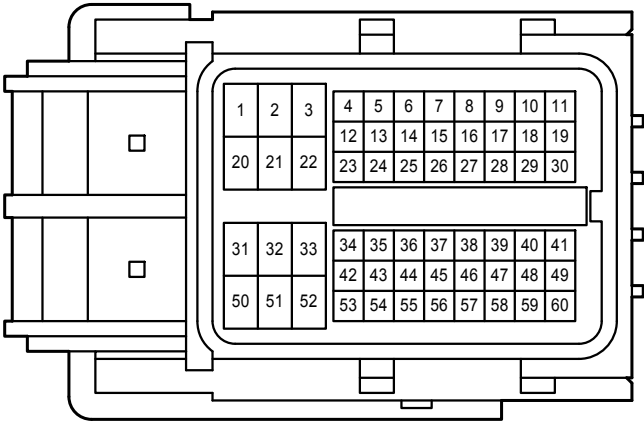

A 26
Black

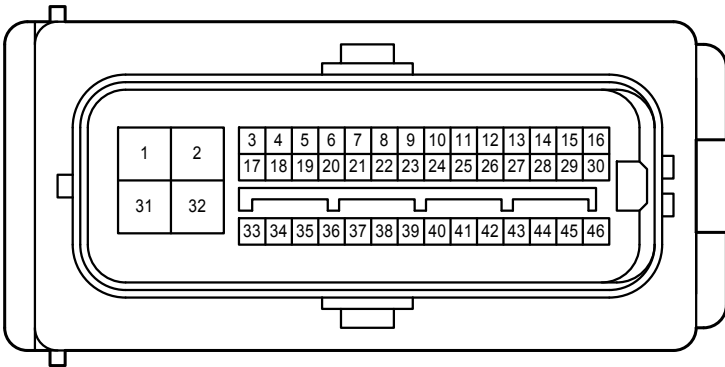

A 32
Black

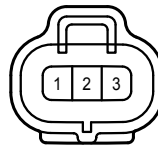

A 51
Gray

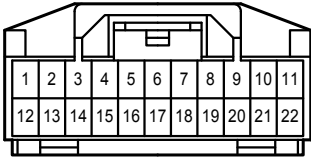

A 52
Gray

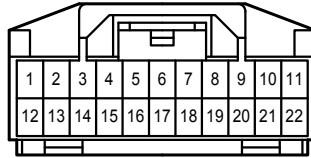

A 54
Black

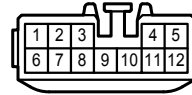

A 55
Gray

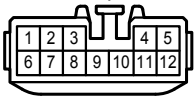

A 64
Black

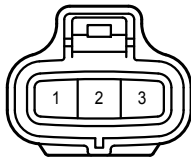

A 65
Black

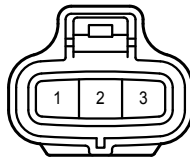

Cooling Fan <2GR-FE>

A 67
Black

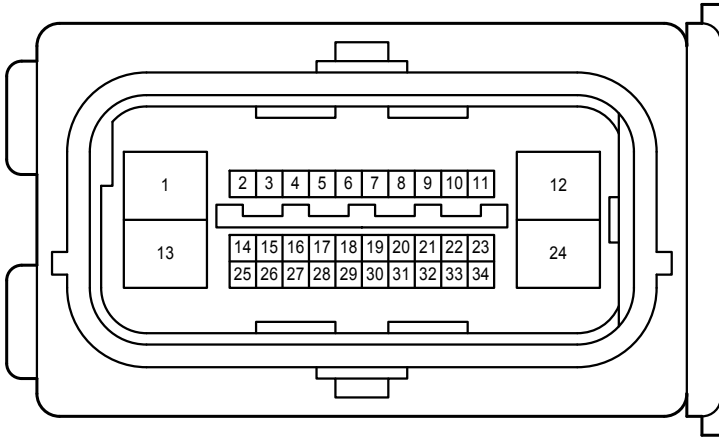

A 80
Gray

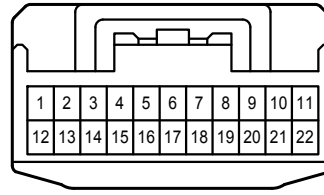

B 4
Gray



B 81
Black

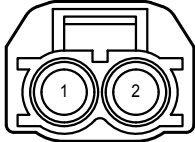

B 96
Black

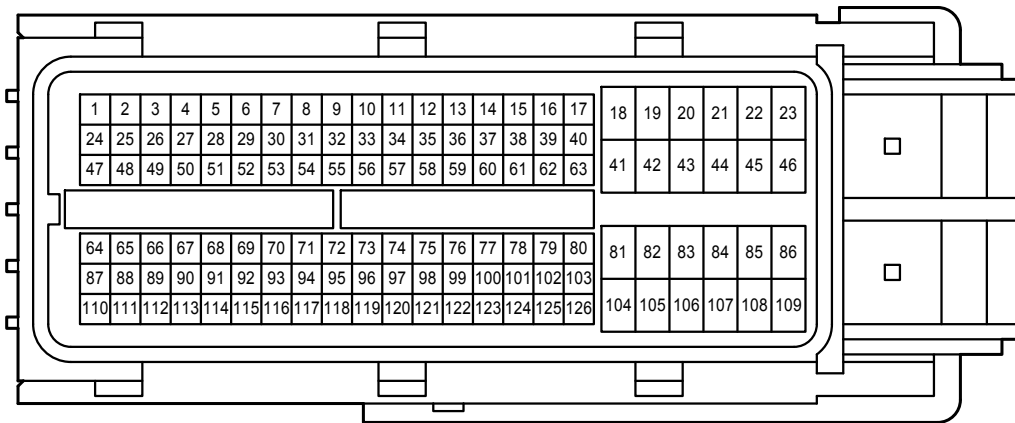

B109
Black



E 22
White

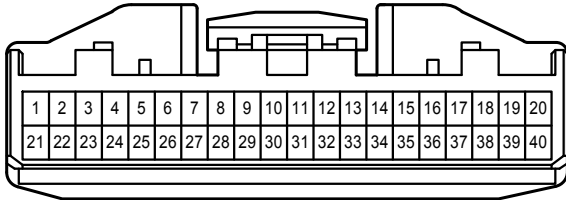

E 41
White

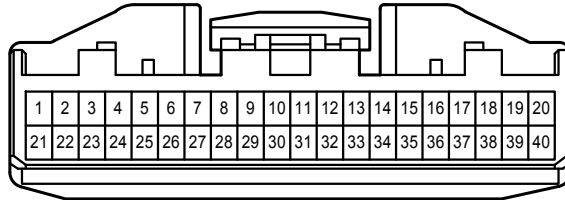

E 42
White

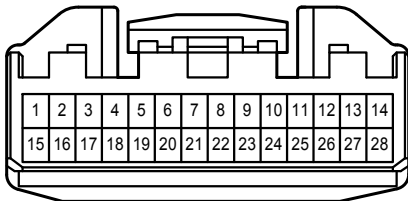

E 77
Gray

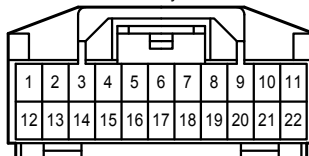

E 87
Gray

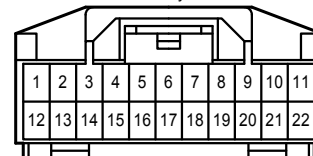

Cooling Fan <2GR-FE>

E 88
Blue

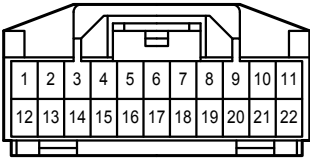

E 89
Blue

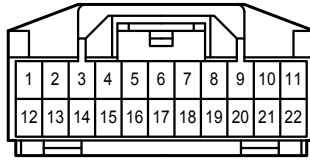

E112
Gray

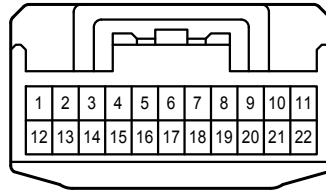

E113
Black

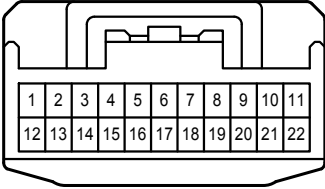

E114
Black

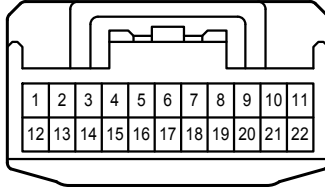

E115
Gray

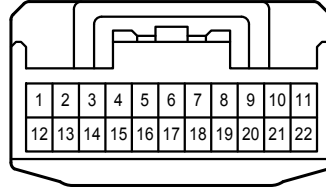

3A
White

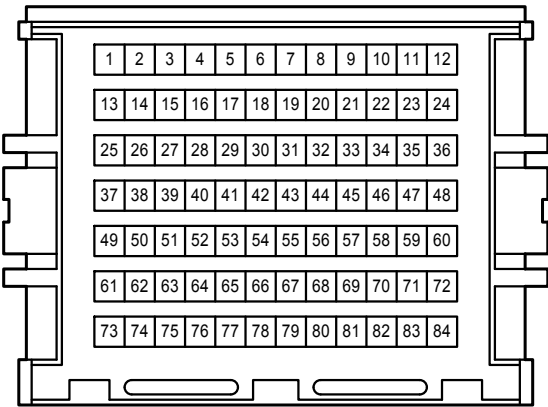

3B
White

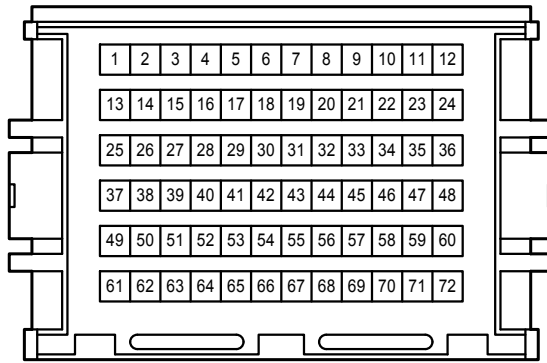

1B
White

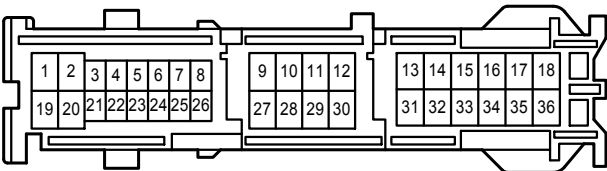

1H
White

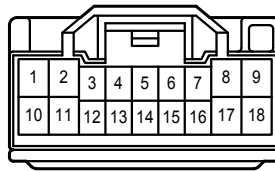

1M
White

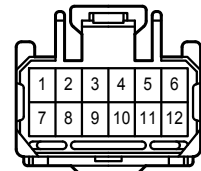

AE4
Gray

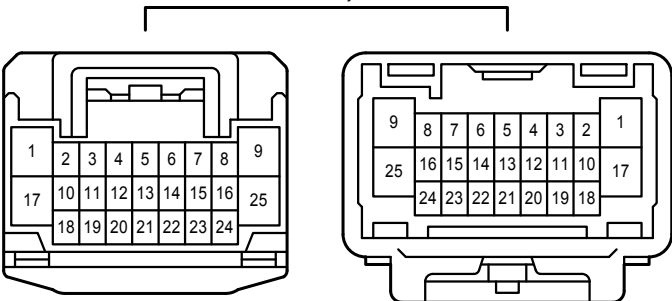

AE6
White

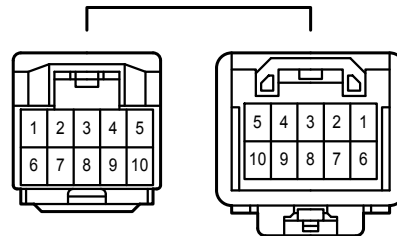

AE7
White

