

- * 1 : Australia
- * 2 : RHD Except Australia
- * 3 : Except 2GR-FE
- * 4 : 2GR-FE
- * 5 : Before Aug. 2008 Production Except Europe, Before Dec. 2008 Production Europe
- * 6 : From Aug. 2008 Production Except Europe, From Dec. 2008 Production Europe
- * 7 : 3ZR-FAE
- * 8 : Except 3ZR-FAE
- * 9 : 2AZ-FE, 1AZ-FE
- * 10 : w/ Charging Control System
- * 11 : w/o Charging Control System
- * 12 : Before Feb. 2010 Production
- * 13 : From Feb. 2010 Production

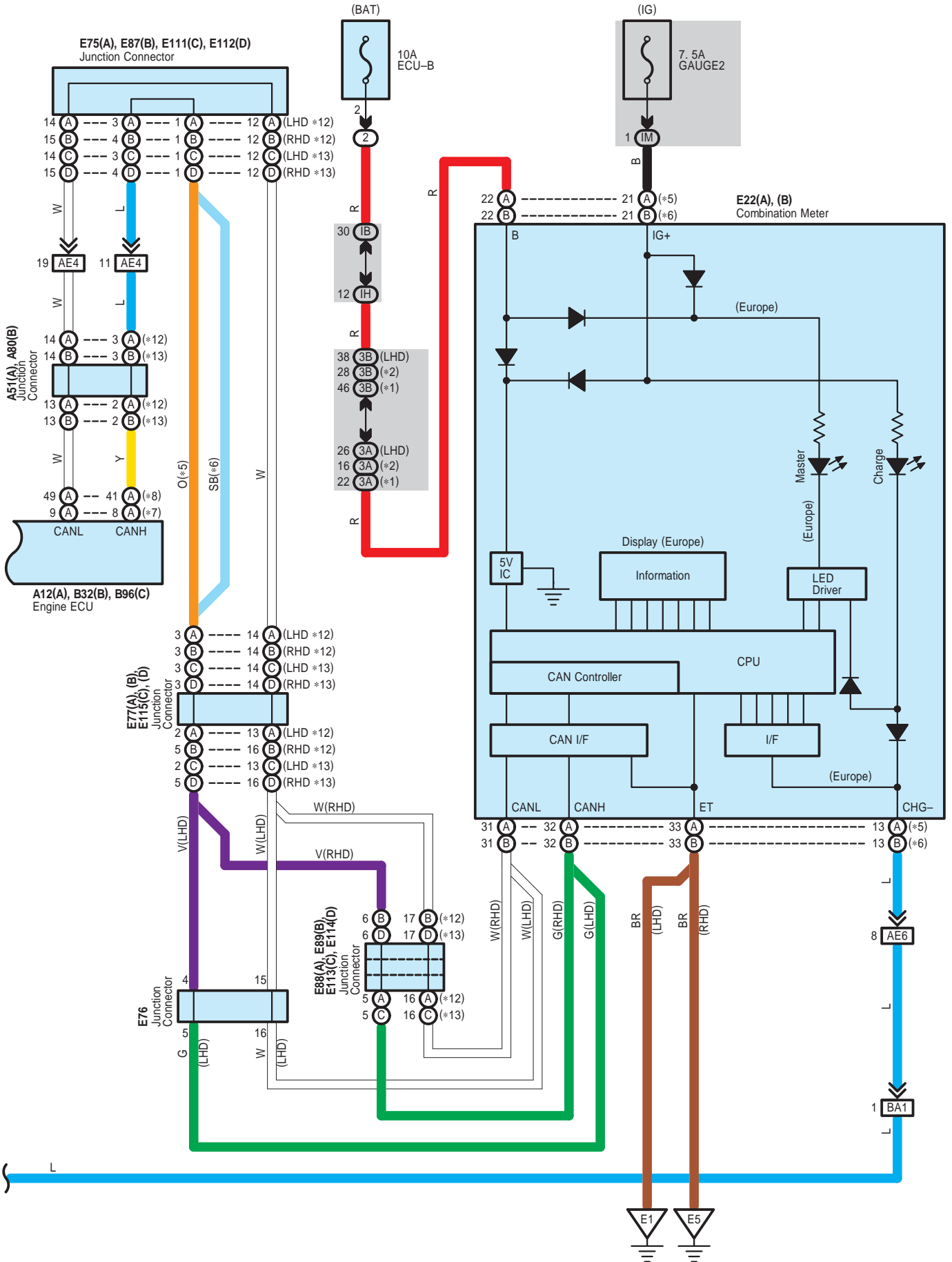

E 22
White

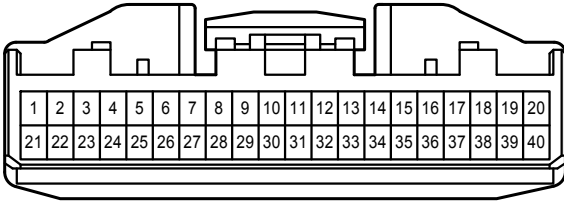

E 75
Gray

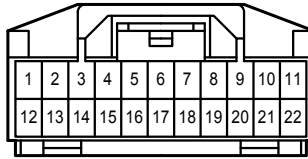

E 76
Black

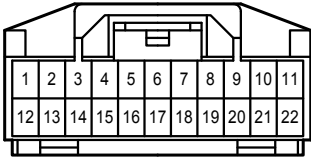

E 77
Gray

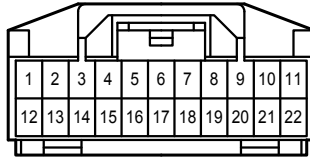

E 87
Gray

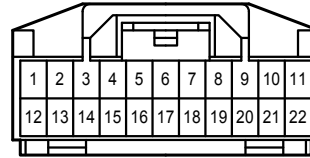

E 88
Blue

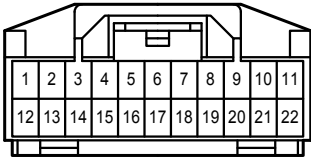

E 89
Blue

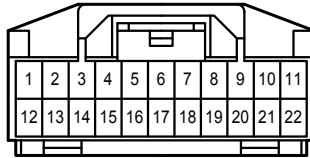

E111
Gray

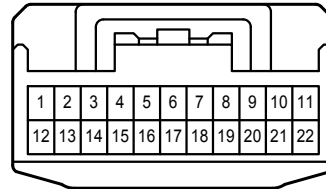

E112
Gray

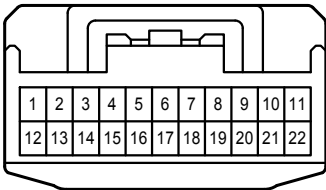

E113
Black

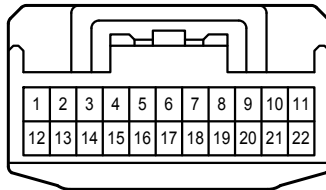

E114
Black

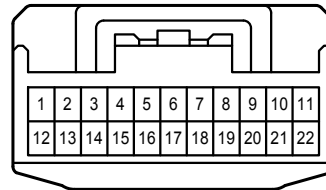

E115
Gray

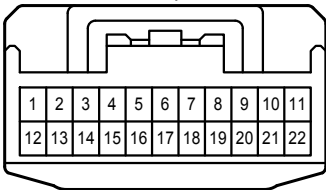

1D

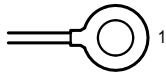

3A

White

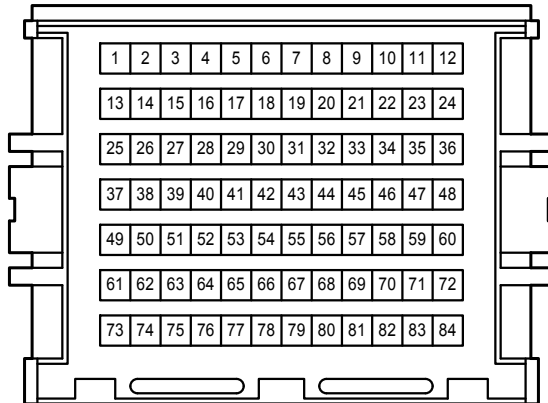

3B
White

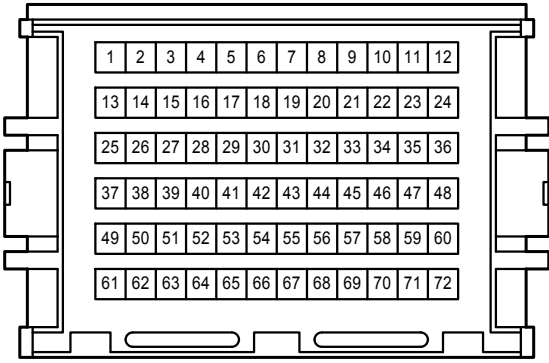

1B
White

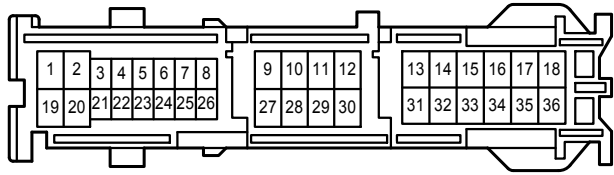

1H
White

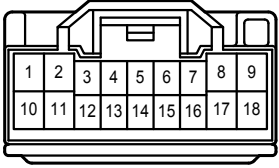

1M
White

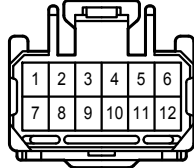

AE4
Gray

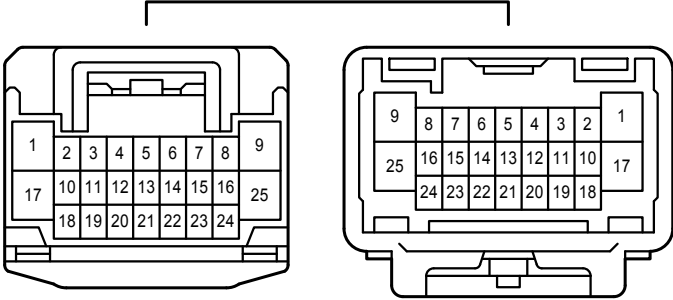

AE6
White

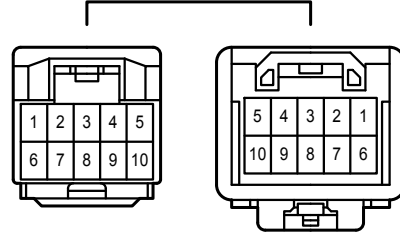

BA1
White

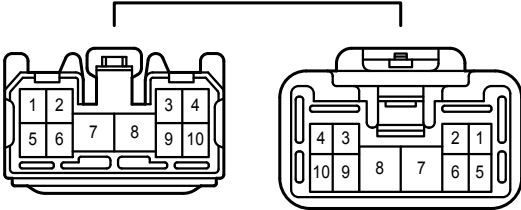

BA2
Gray

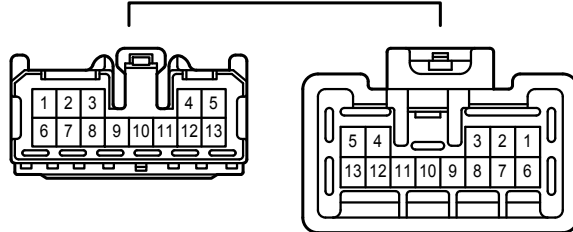

BA4
White

