

Engine Control <2AD-FHV>

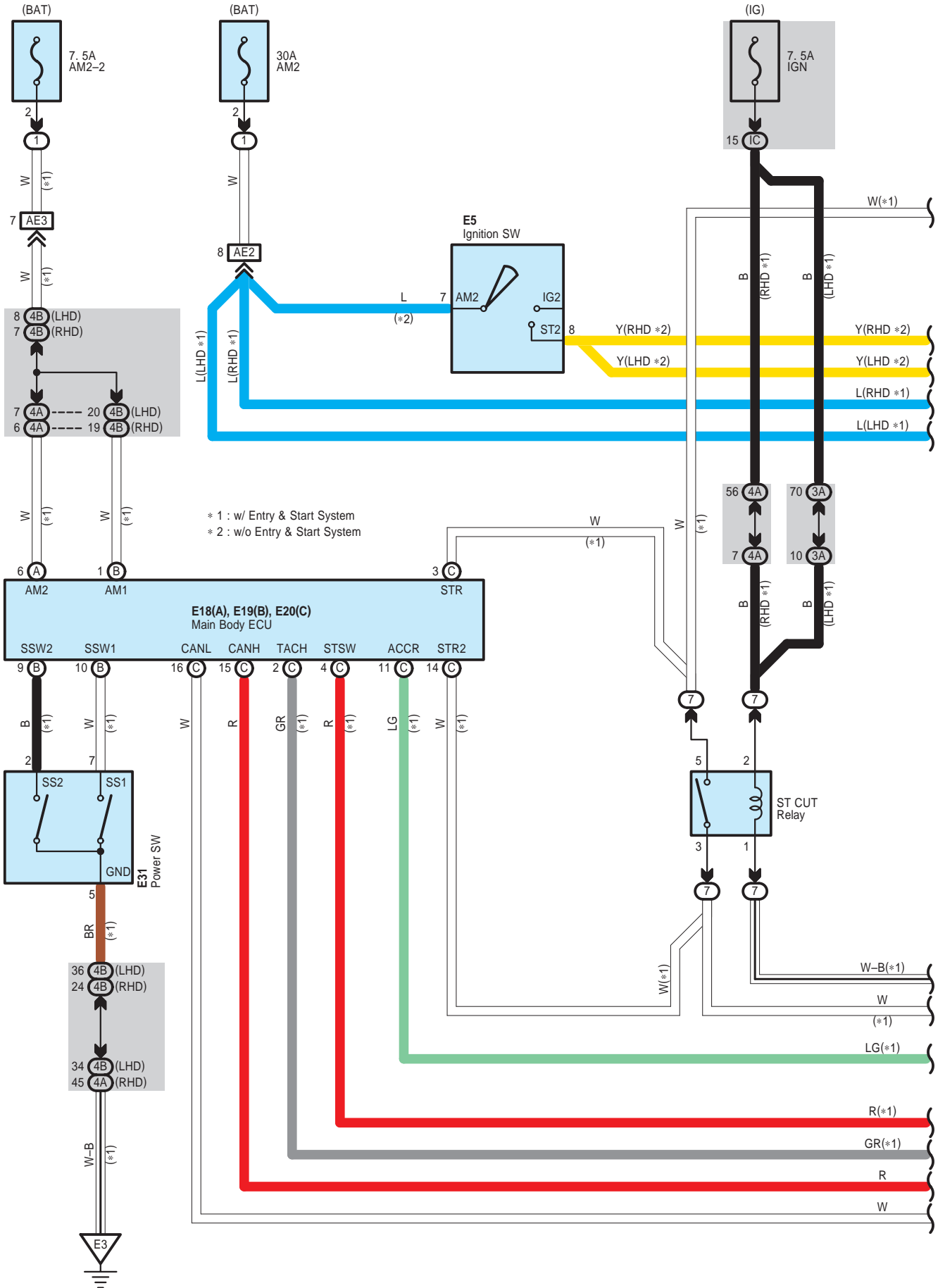

Engine Control <2AD-FHV>

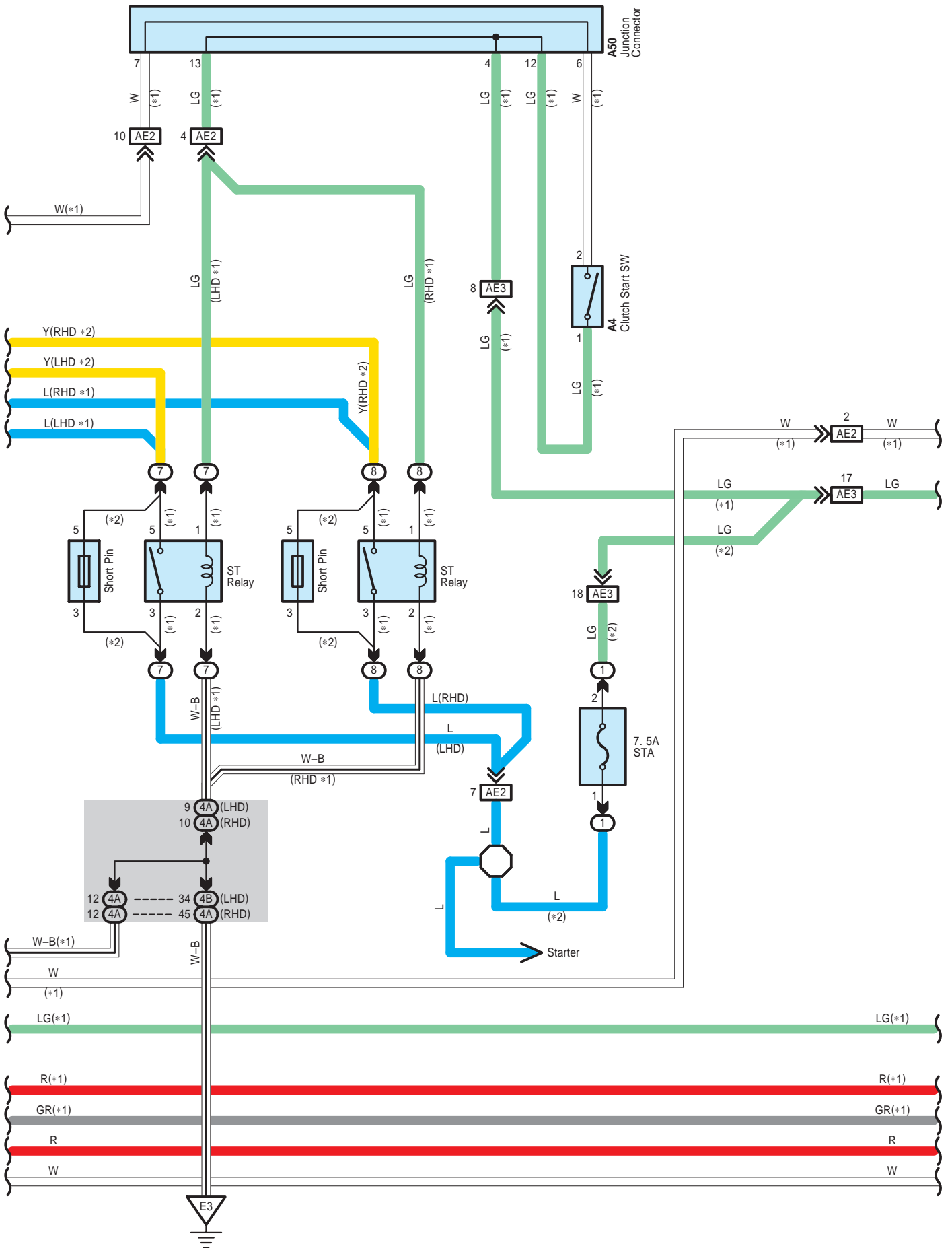

Engine Control <2AD-FHV>

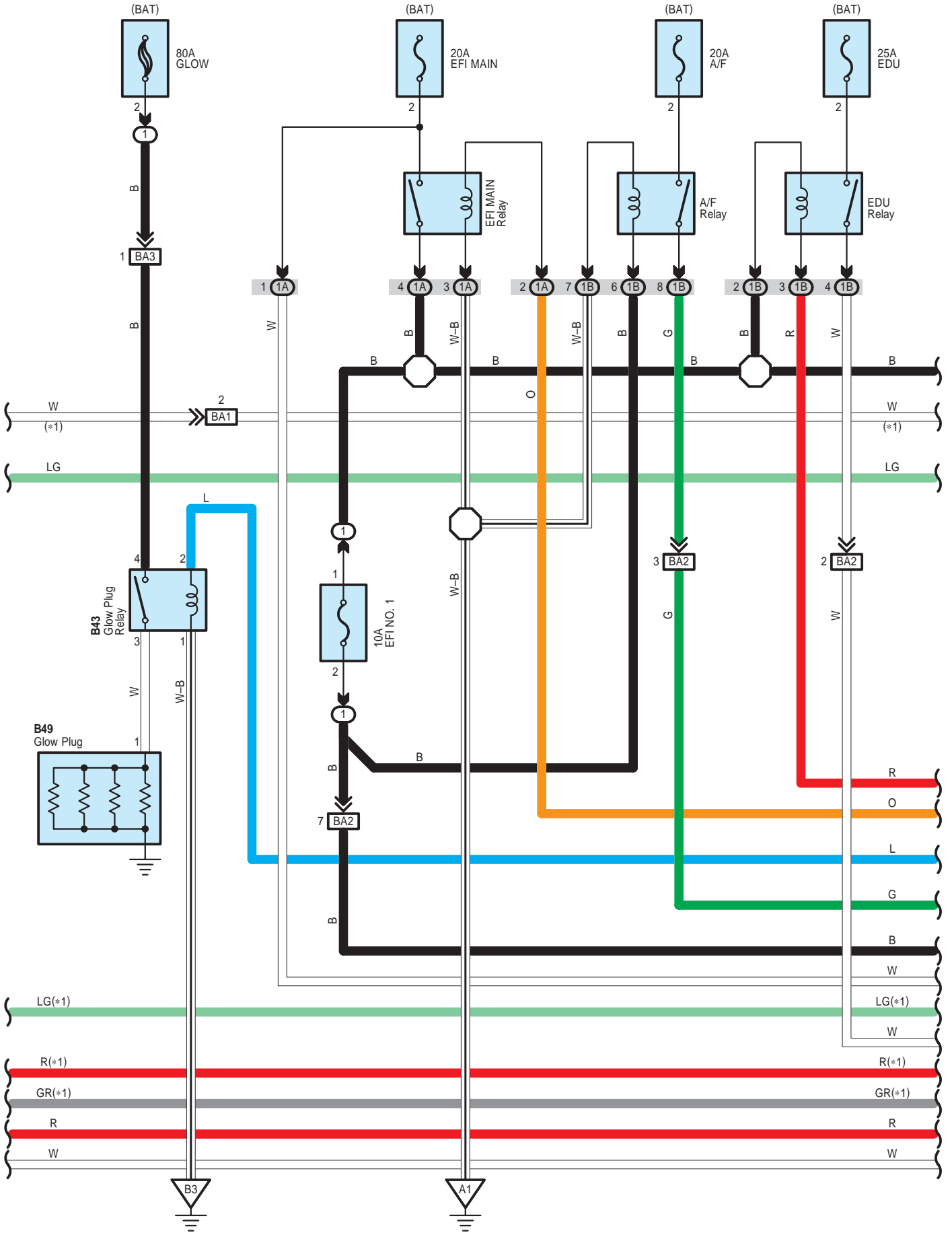

* 1 : w/ Entry & Start System

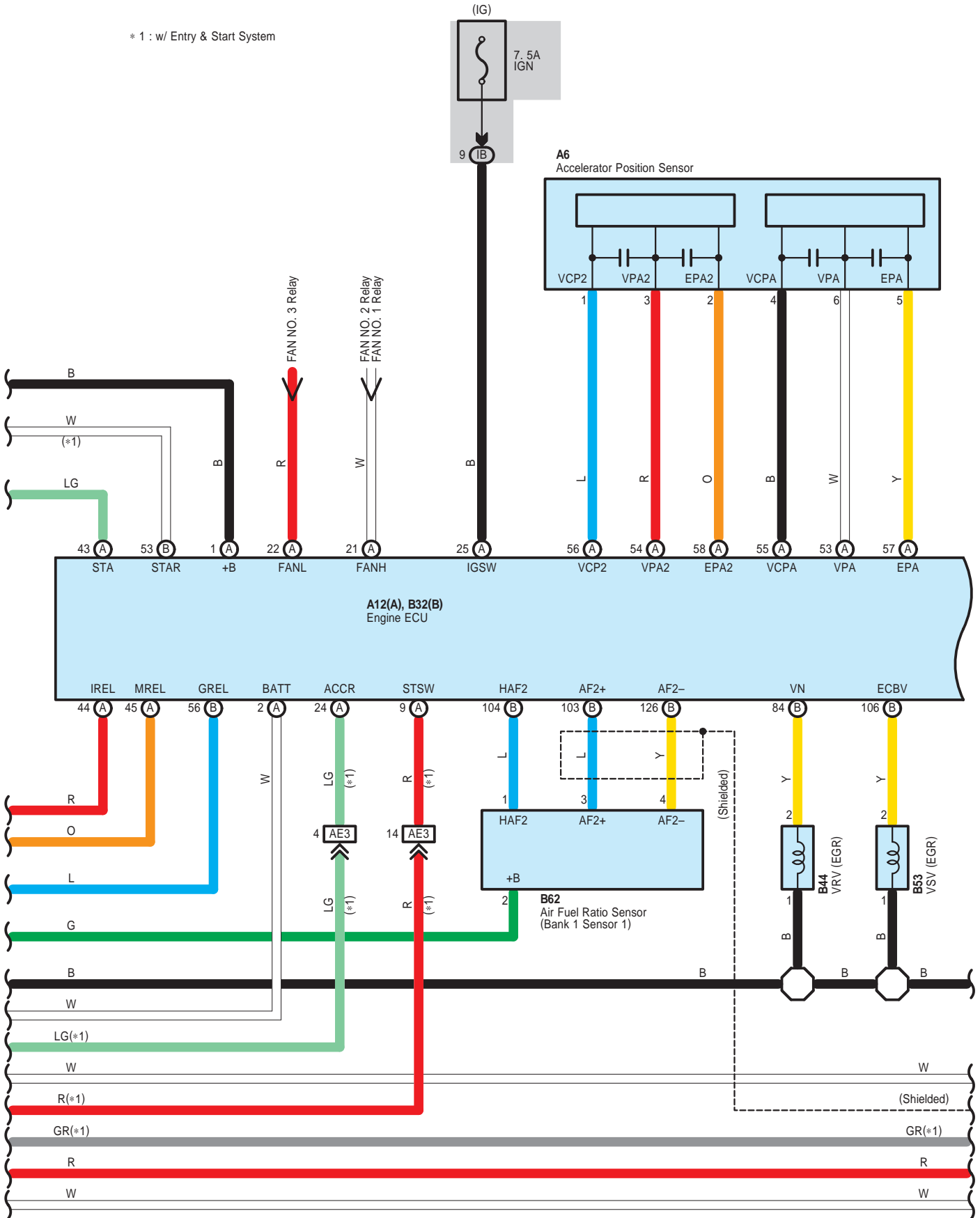

- * 1 : w/ Entry & Start System
- * 3 : w/ Auto Wiper System
- * 4 : w/o Auto Wiper System
- * 5 : RH Wiper Lever Type
- * 6 : LH Wiper Lever Type

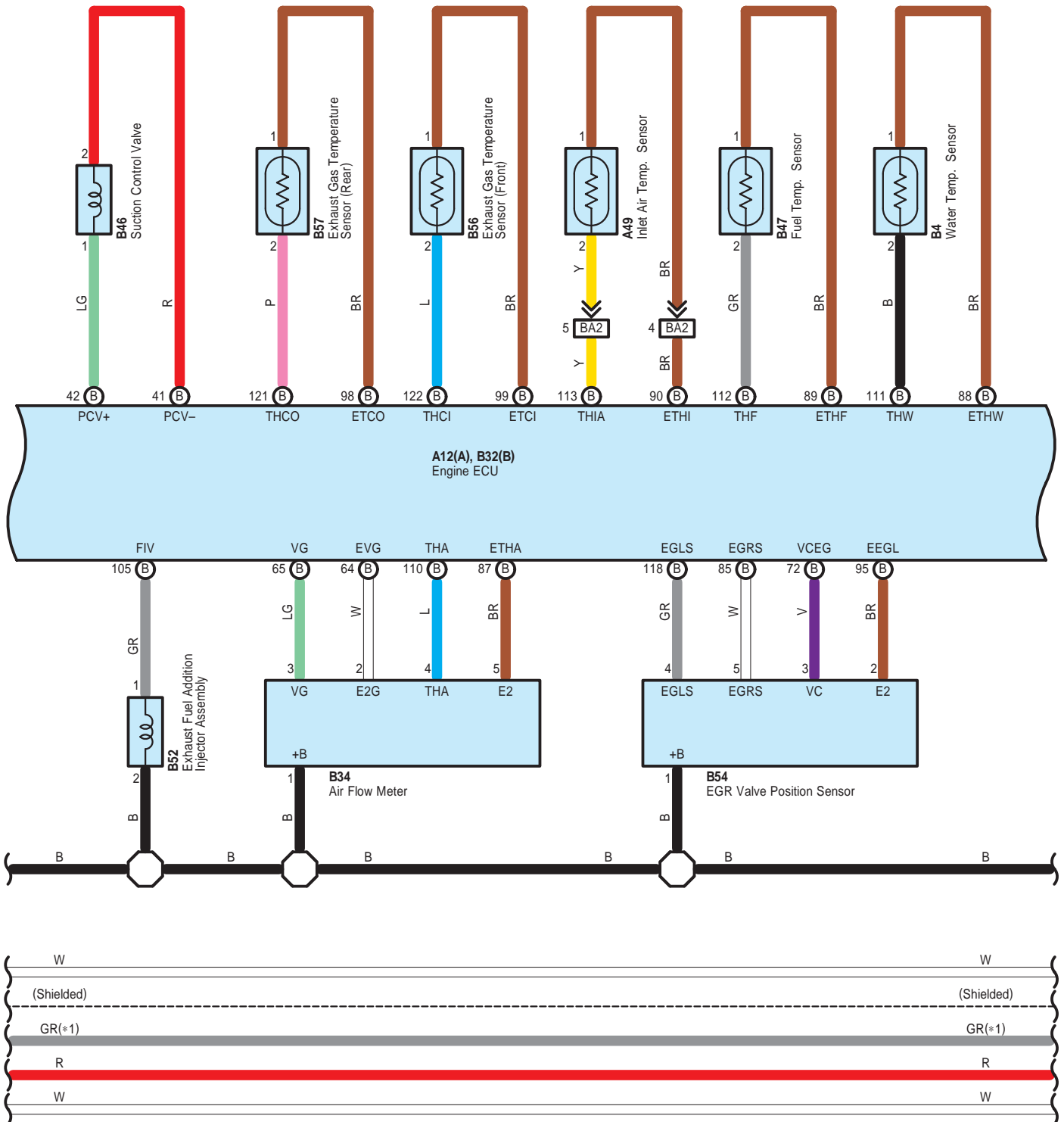

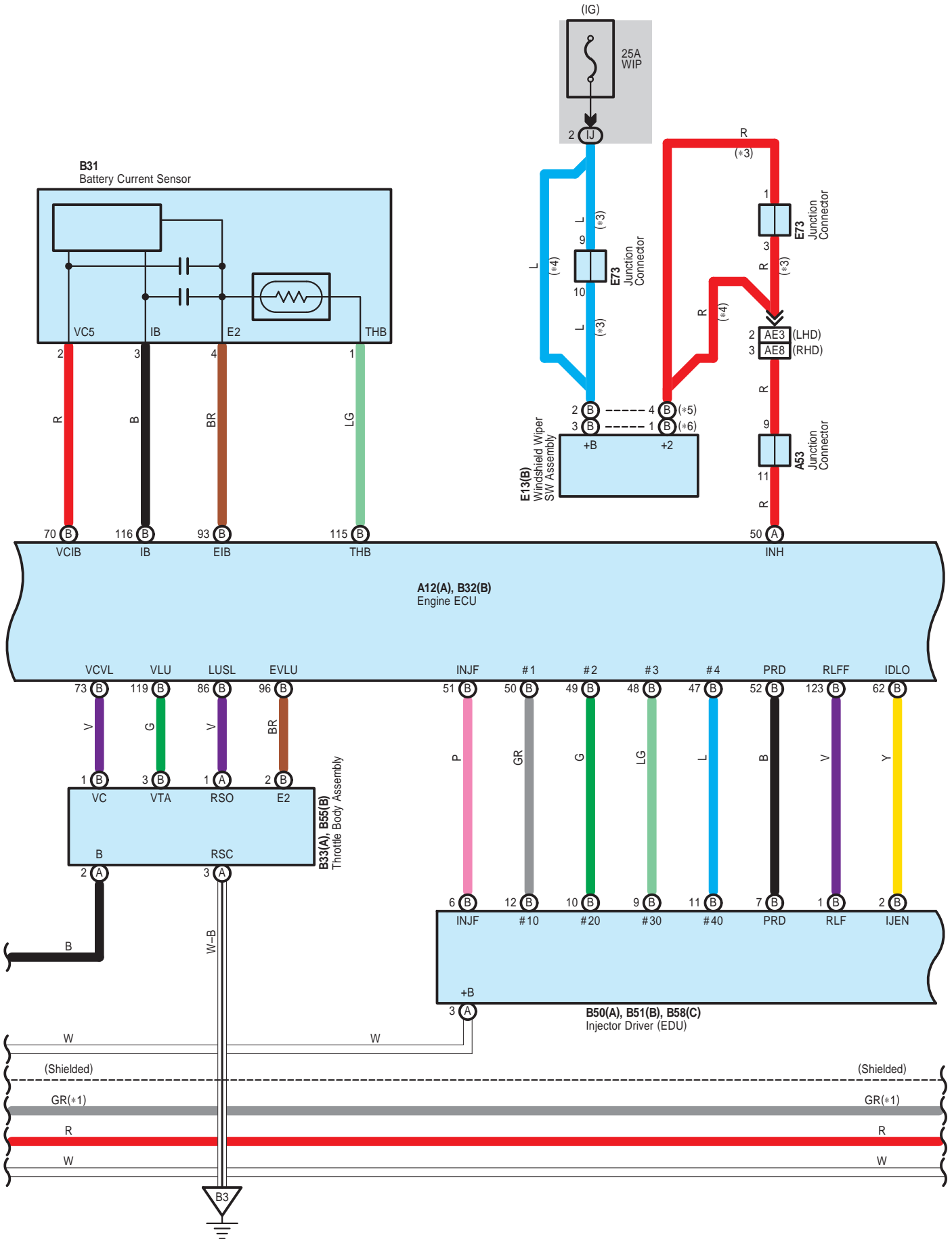

Engine Control <2AD-FHV>

- * 1 : w/ Entry & Start System
- * 2 : w/o Entry & Start System

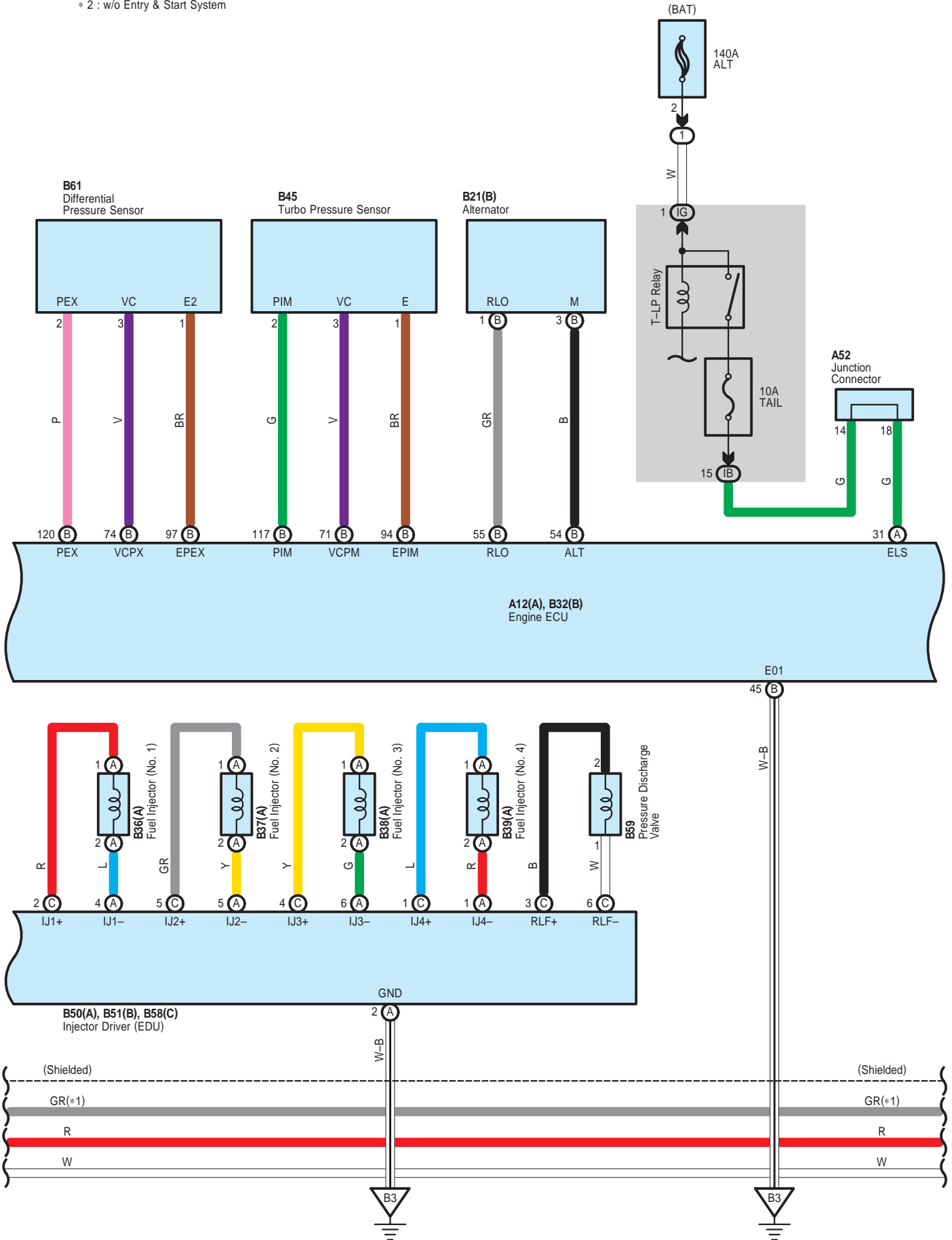

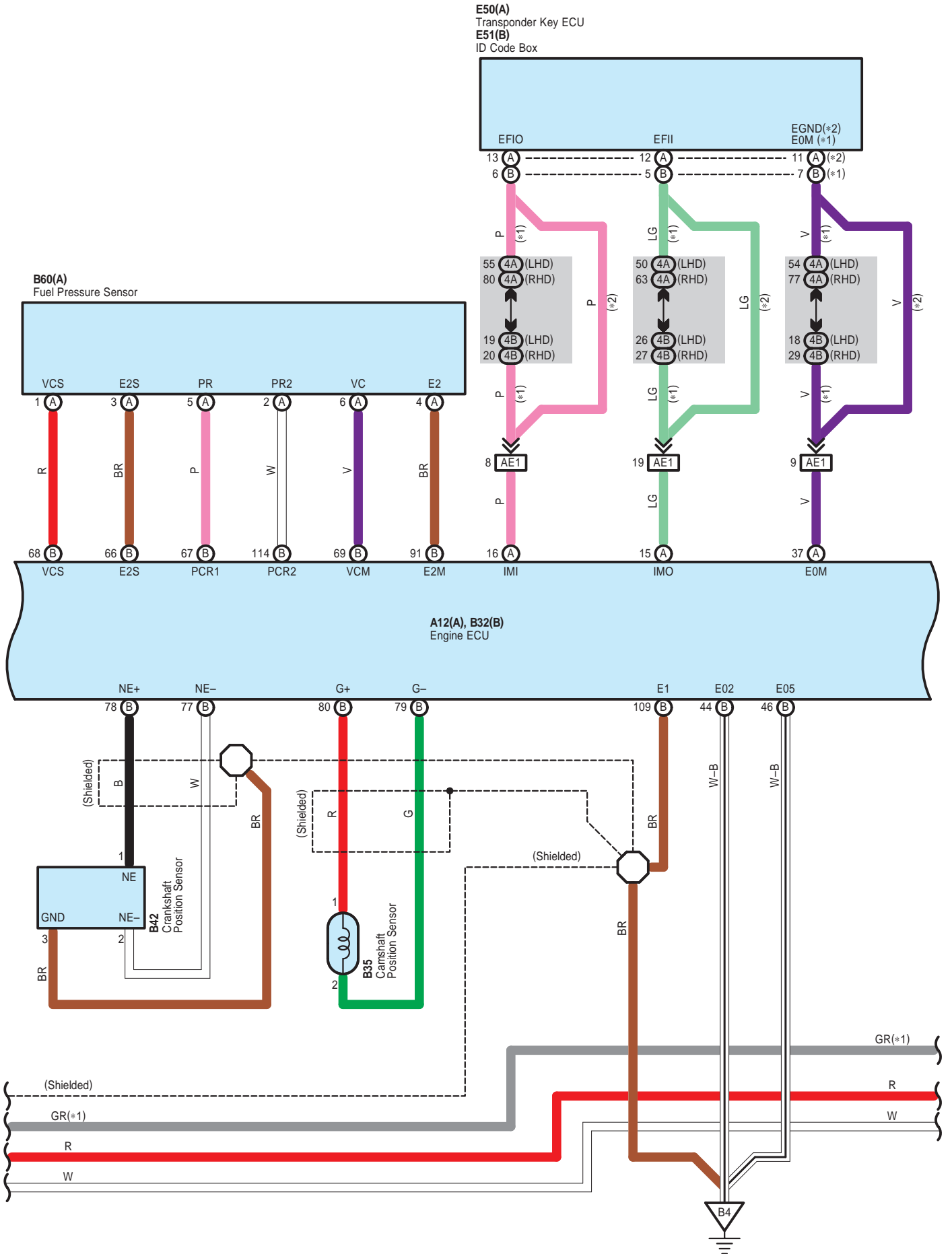

Engine Control <2AD-FHV>

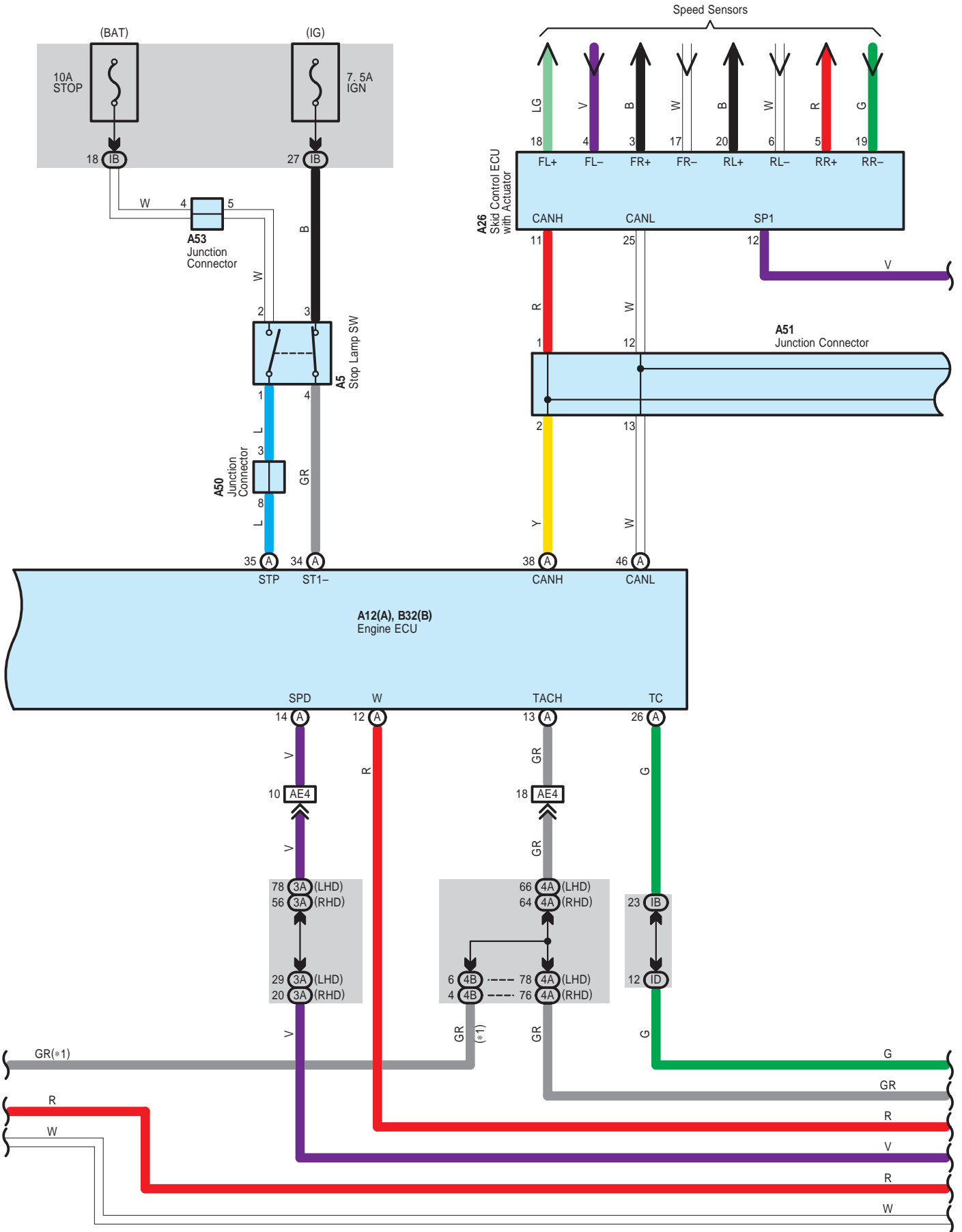

* 1 : w/ Entry & Start System

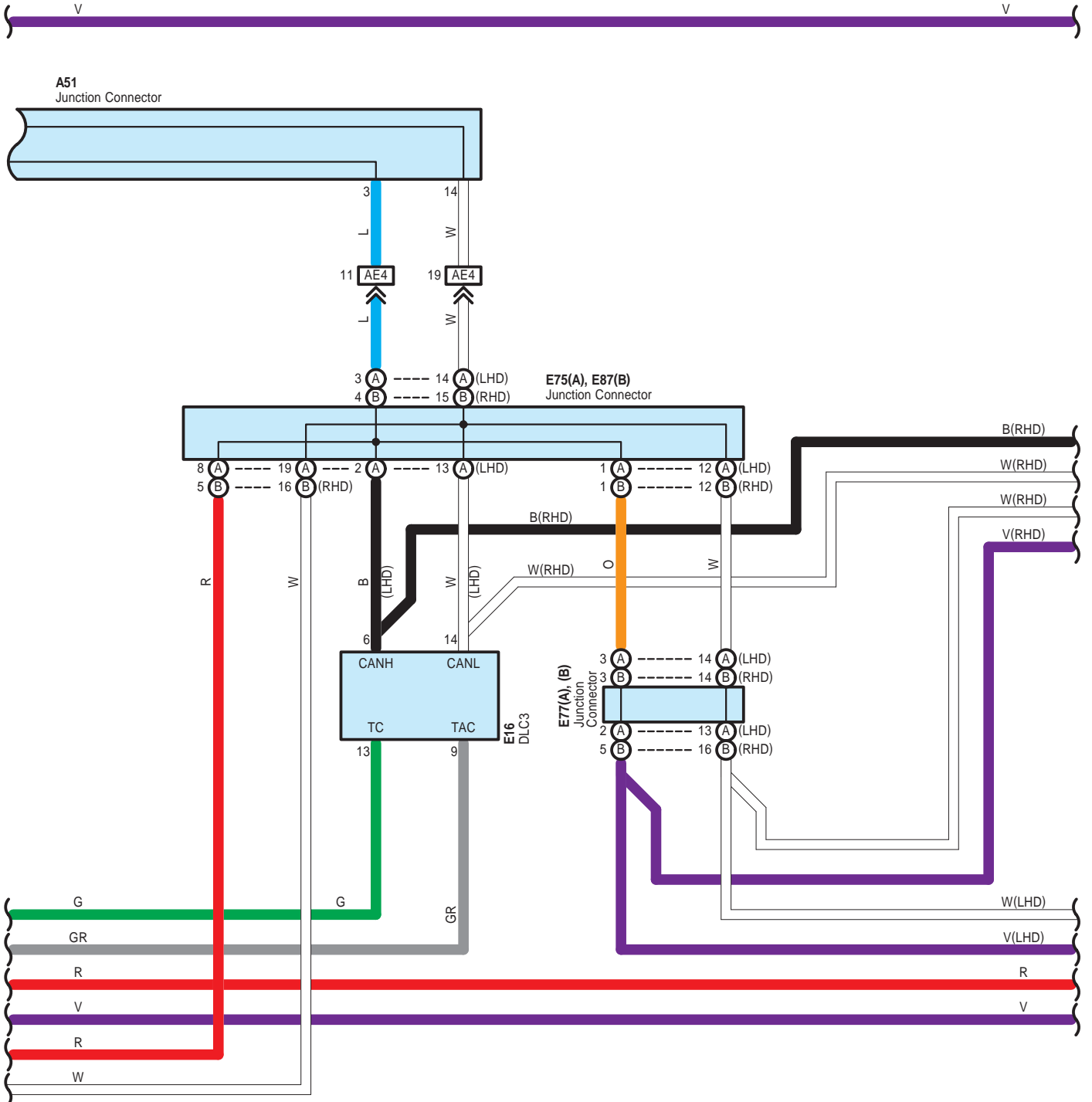

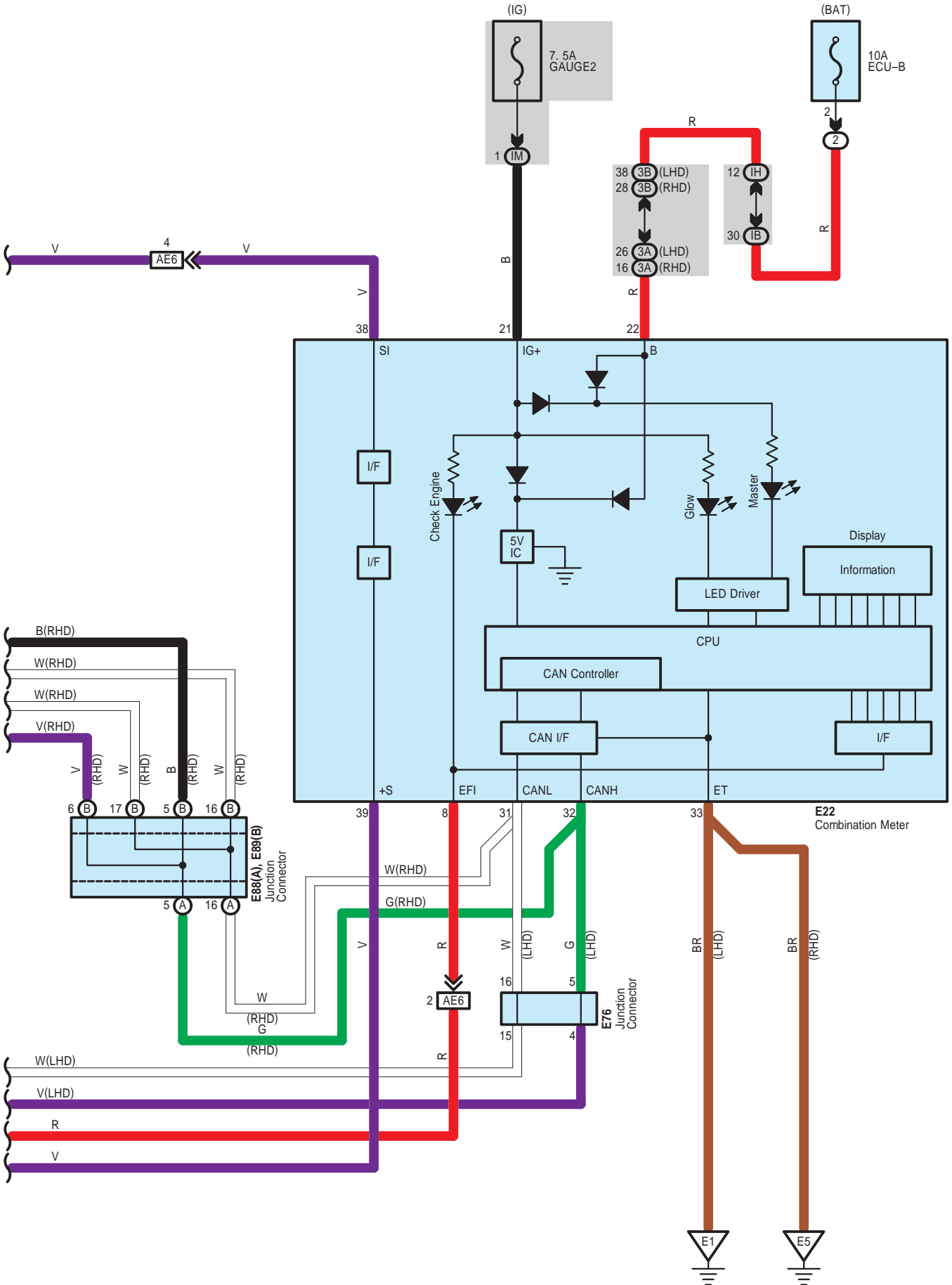

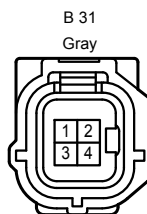
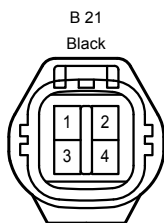
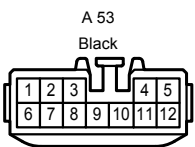
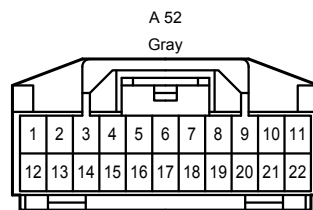
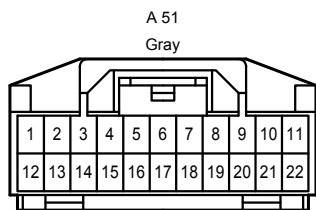
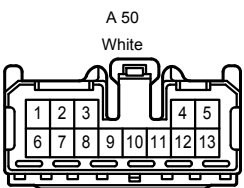
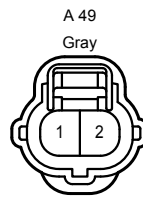
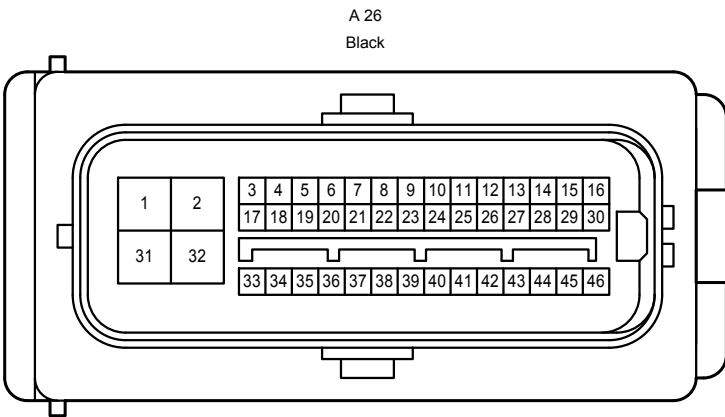
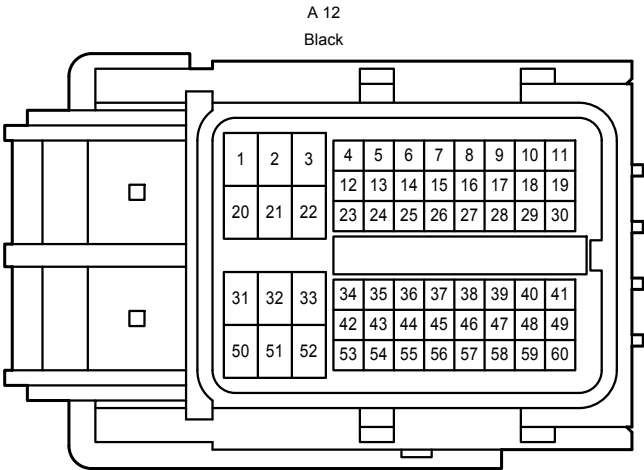
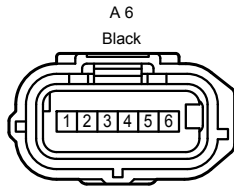
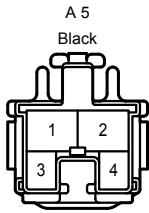
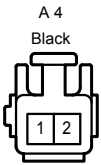

Engine Control <2AD-FHV>

B 32
Black

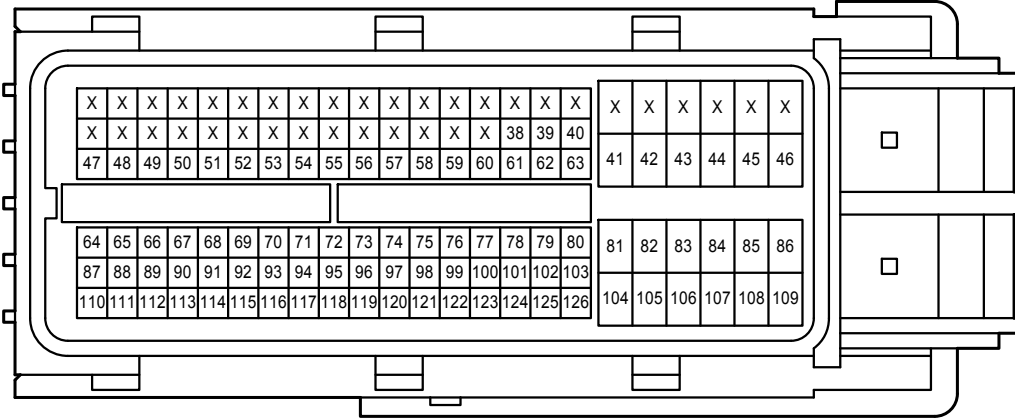

B 33
Black



B 34
Black

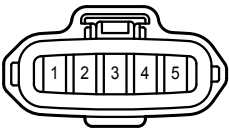

B 35
Black



B 36
Black

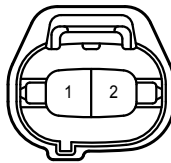

(2AD-FHV)

B 37
Gray

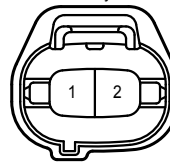

(2AD-FHV)

B 38
Black

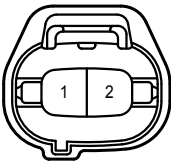

(2AD-FHV)

B 39
Gray

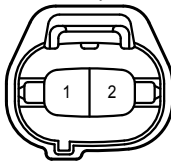

(2AD-FHV)

B 42
Gray



B 43
Gray

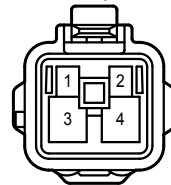

B 44
Black



B 45
Black

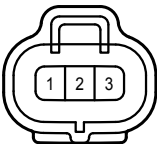

B 46
Gray



B 47
Gray



B 49

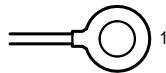

B 50
Gray



B 51
Black

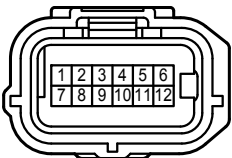

B 52
Black



B 53
Black

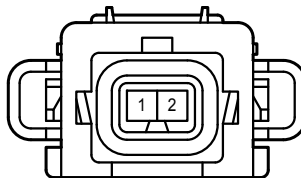

B 54
Black

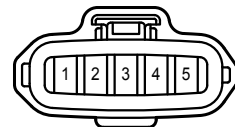

B 55
Black



B 56
Gray



B 57
Dark Gray



B 58
Dark Gray



B 59
Gray



B 60

Black



(2AD-FHV)

B 61

Black



B 62

Dark Gray



E 5

White

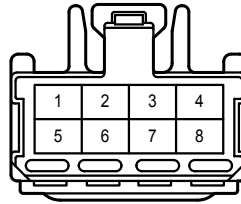

E 13

White



E 16

White

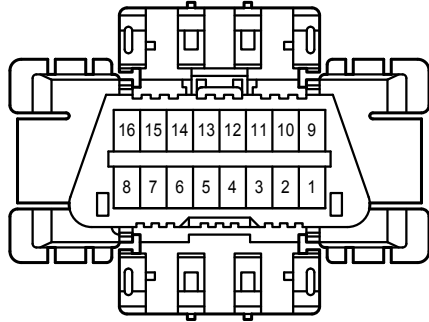

E 18

White

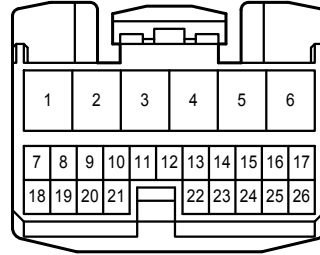

E 19

White

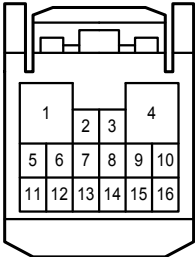

E 20

White

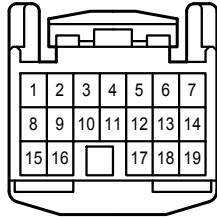

E 22

White

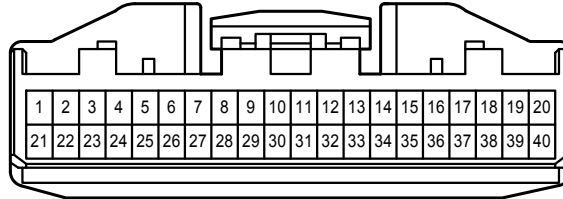

E 31

Black

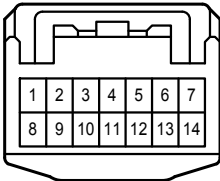

E 50

White

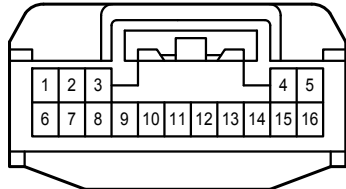

E 51

White

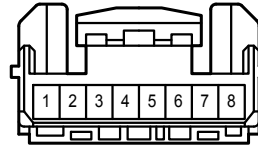

E 73

Black

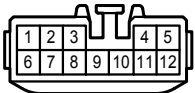

E 75

Gray

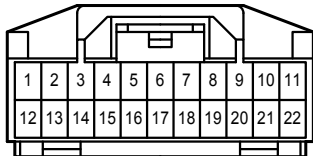

E 76

Black

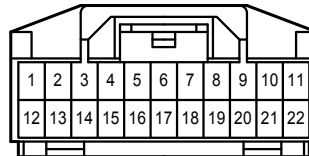

E 77

Gray

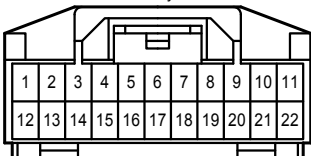

E 87

Gray

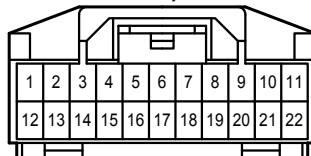

E 88

Blue

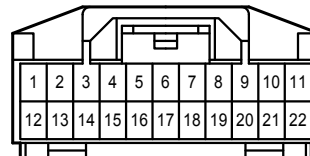

Engine Control <2AD-FHV>

E 89
Blue

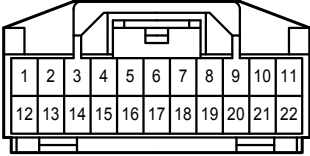

1A
White

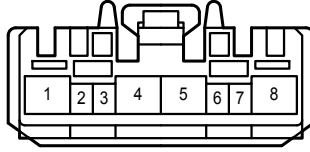

1B
White

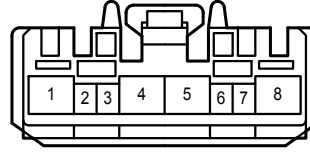

3A
White

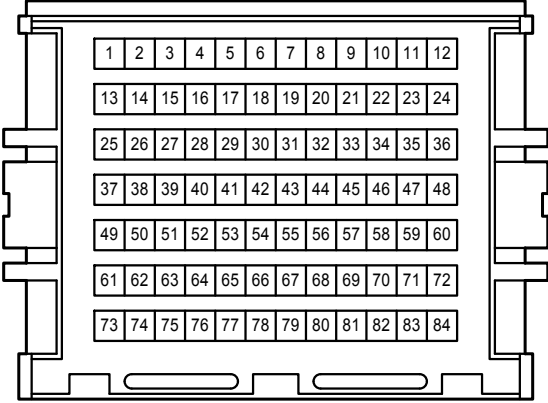

3B
White

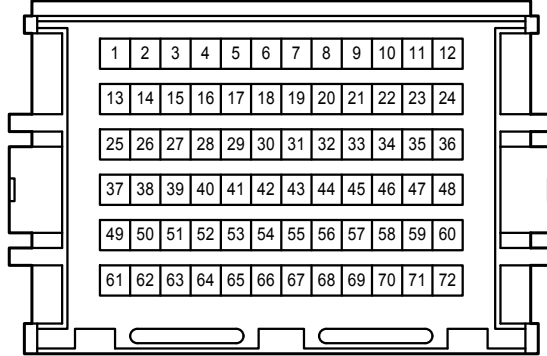

4A
White

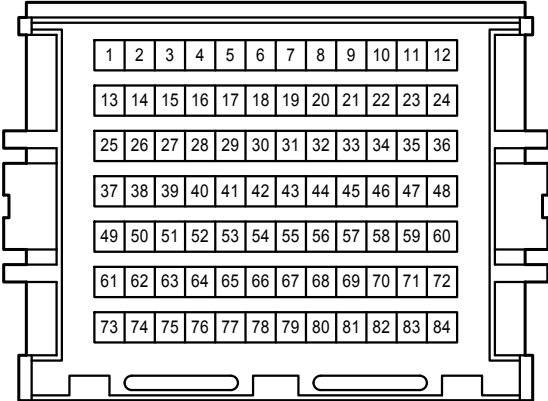

4B
White

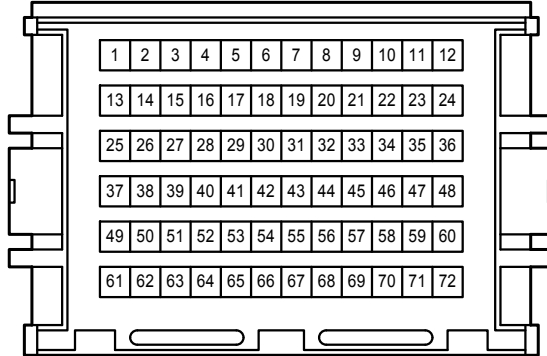

1B
White

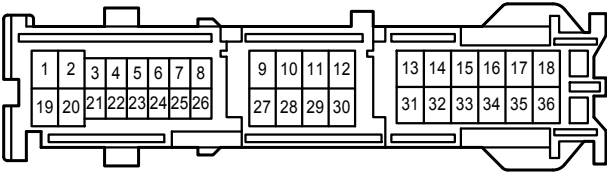

1C
White

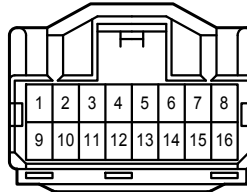

1D
White

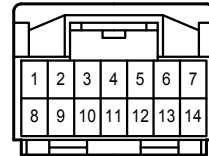

1F
White

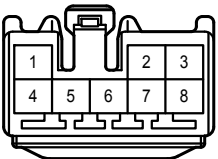

1G
White

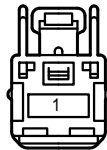

1H
White

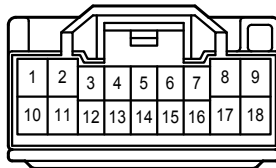

1J
White

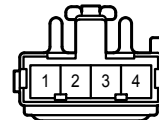

Engine Control <2AD-FHV>

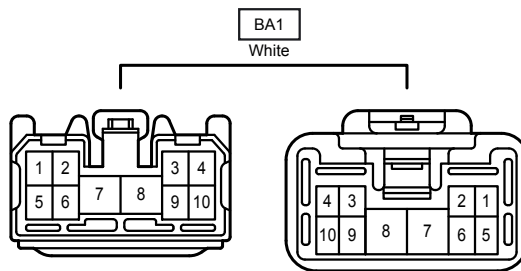
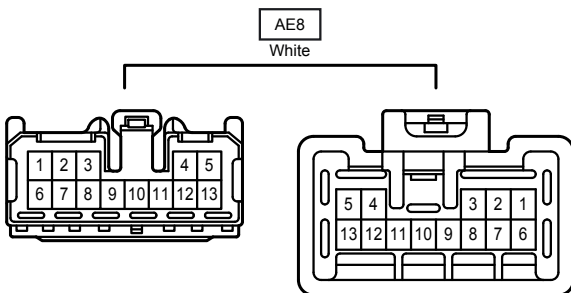
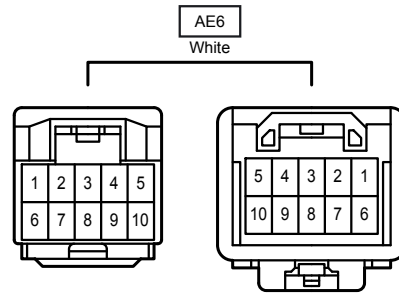
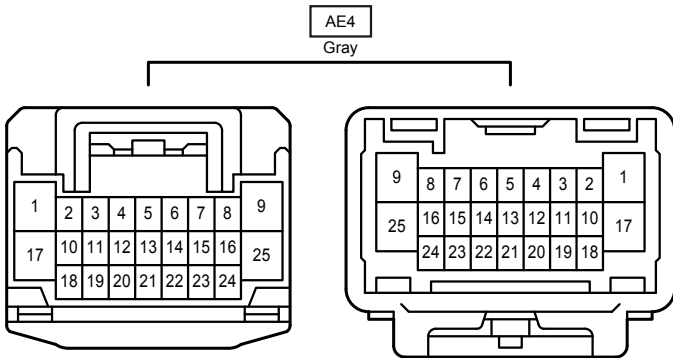
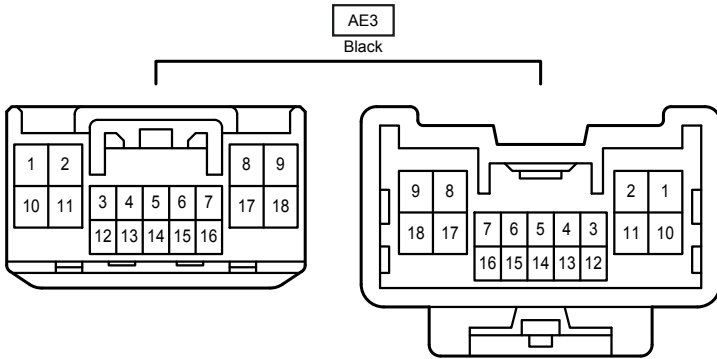
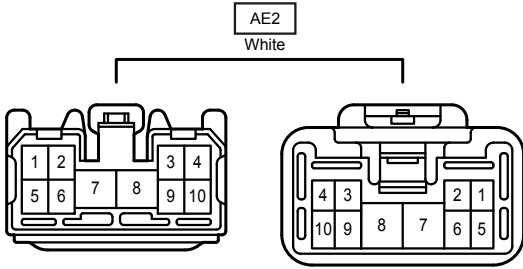
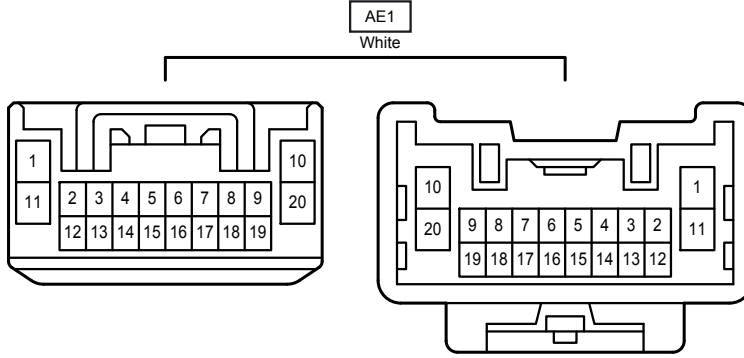
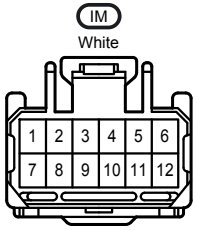

BA2
Gray

BA3
White

