

**Engine Control <2AZ-FE, 1AZ-FE>**

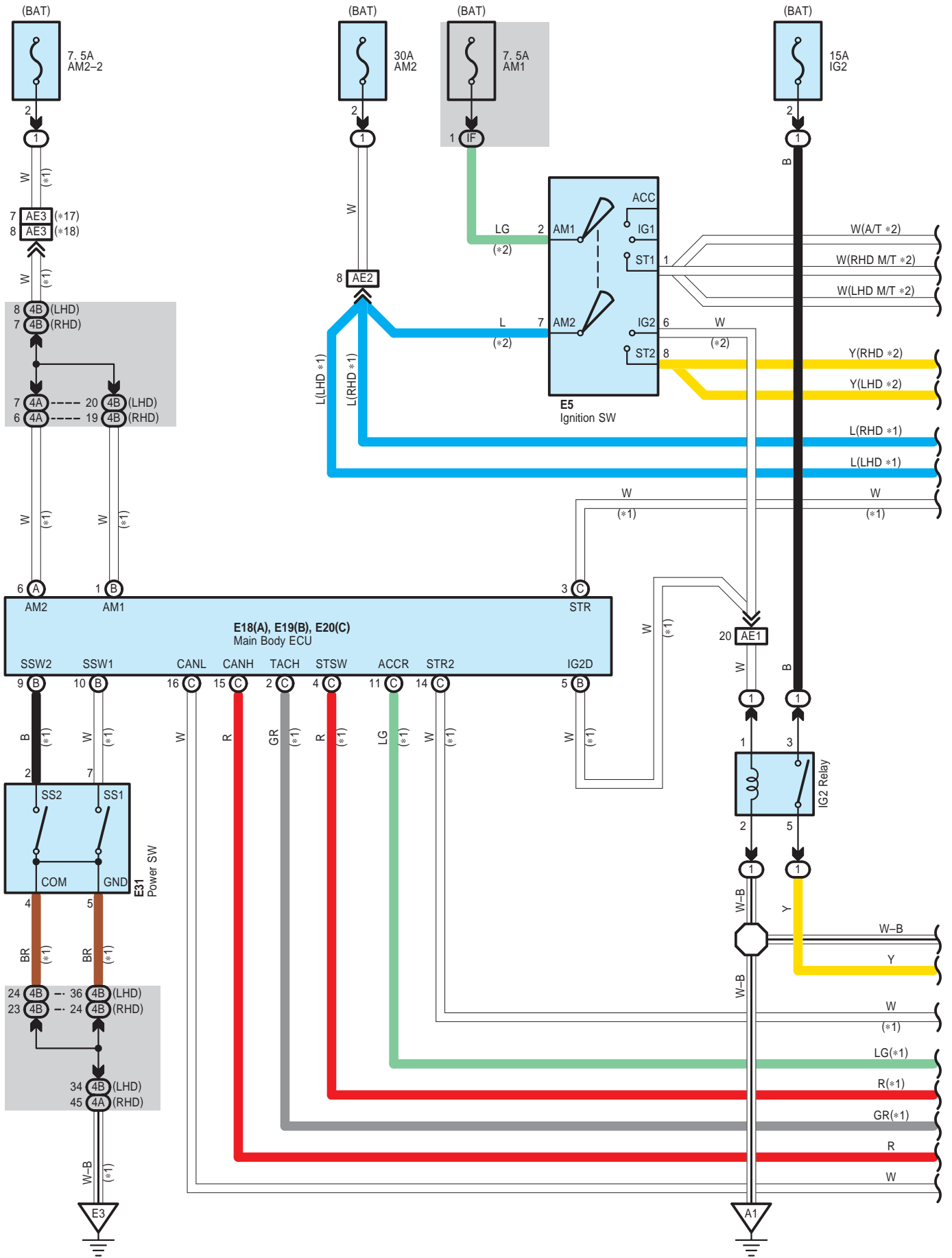

Engine Control <2AZ-FE, 1AZ-FE>

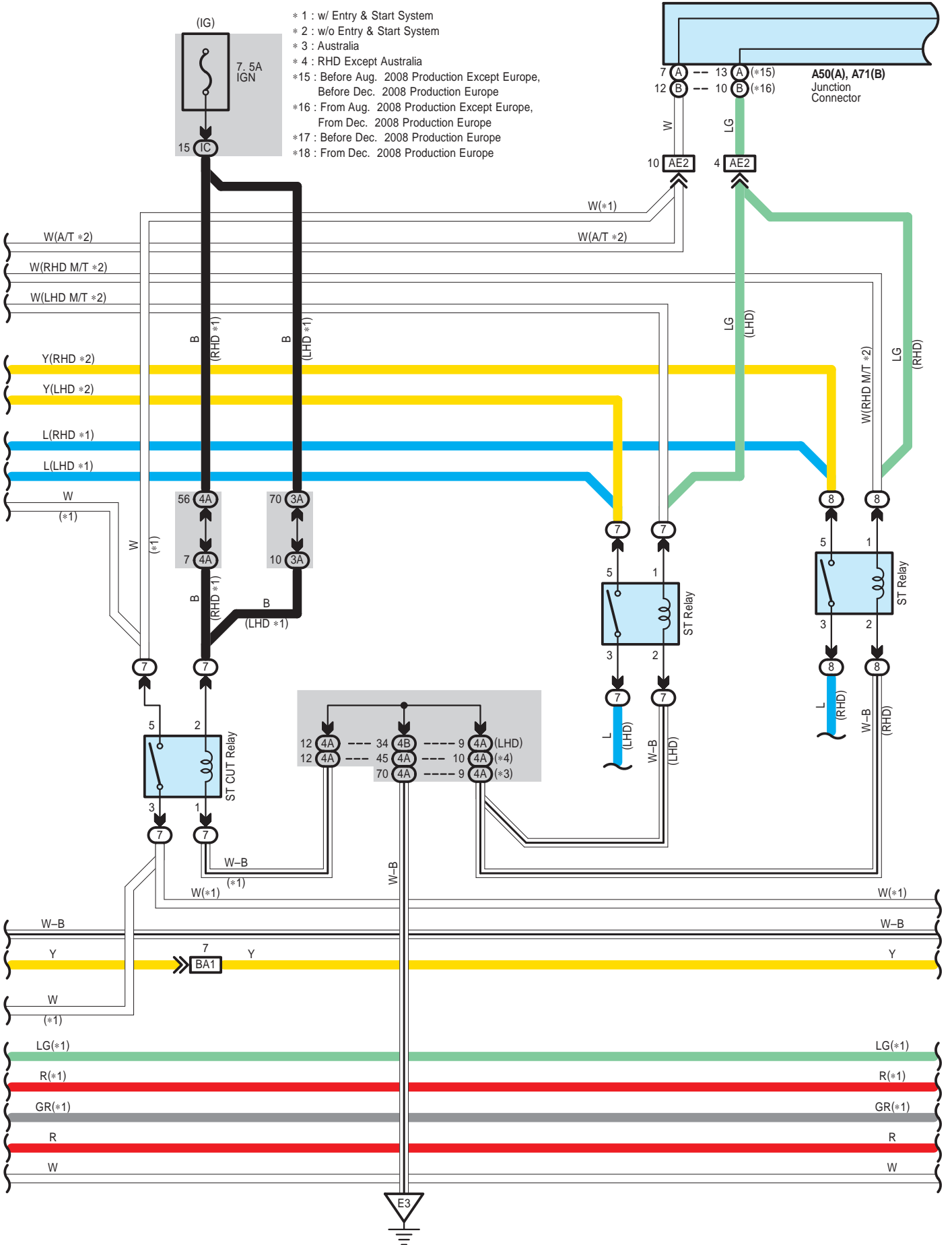

- \* 1 : w/ Entry & Start System
- \* 2 : w/o Entry & Start System
- \* 3 : Australia
- \* 4 : RHD Except Australia
- \* 15 : Before Aug. 2008 Production Except Europe, Before Dec. 2008 Production Europe
- \* 16 : From Aug. 2008 Production Except Europe, From Dec. 2008 Production Europe
- \* 17 : Before Dec. 2008 Production Europe
- \* 18 : From Dec. 2008 Production Europe

Engine Control <2AZ-FE, 1AZ-FE>

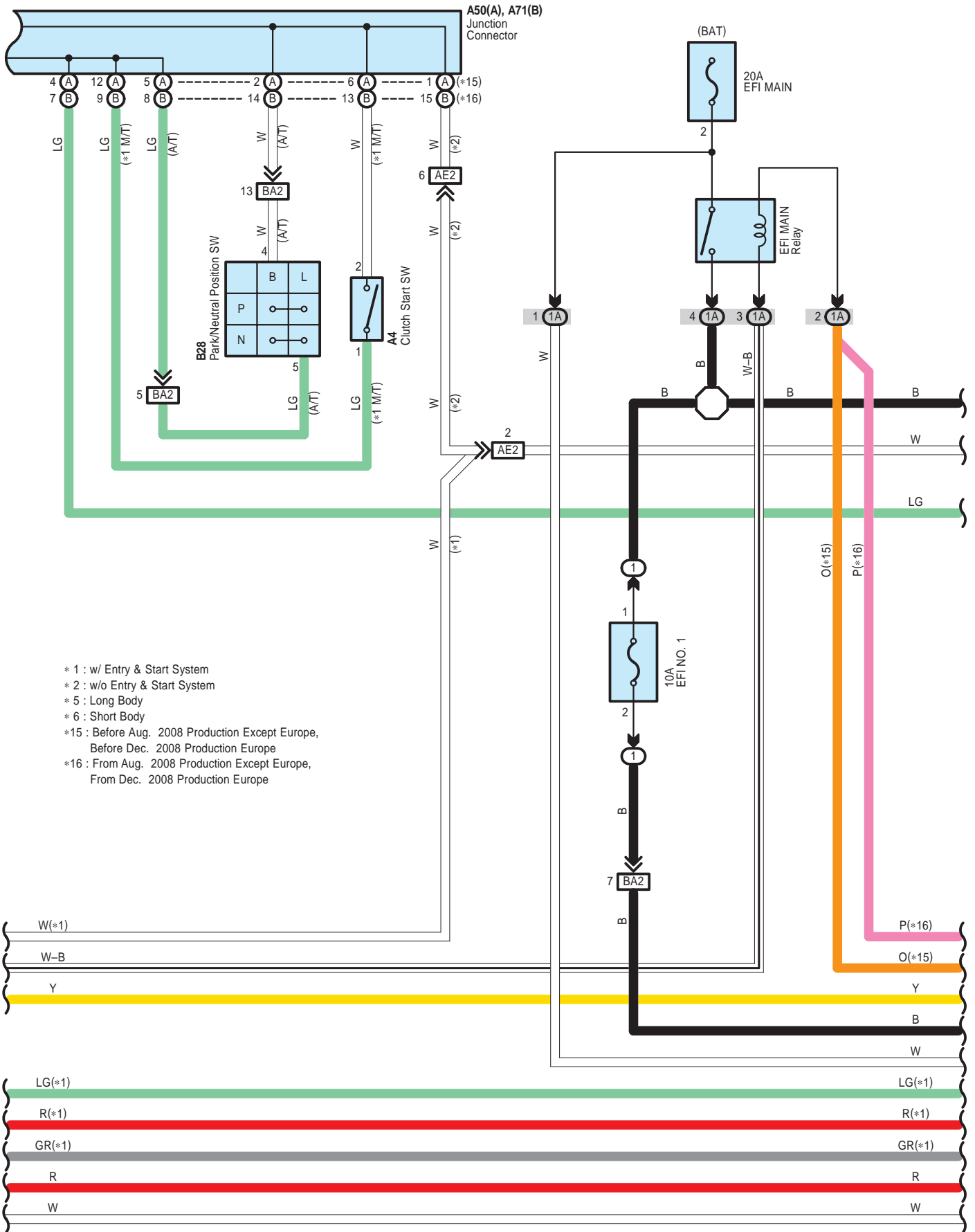

- \* 1 : w/ Entry & Start System
- \* 2 : w/o Entry & Start System
- \* 5 : Long Body
- \* 6 : Short Body
- \*15 : Before Aug. 2008 Production Except Europe,  
Before Dec. 2008 Production Europe
- \*16 : From Aug. 2008 Production Except Europe,  
From Dec. 2008 Production Europe

Engine Control <2AZ-FE, 1AZ-FE>

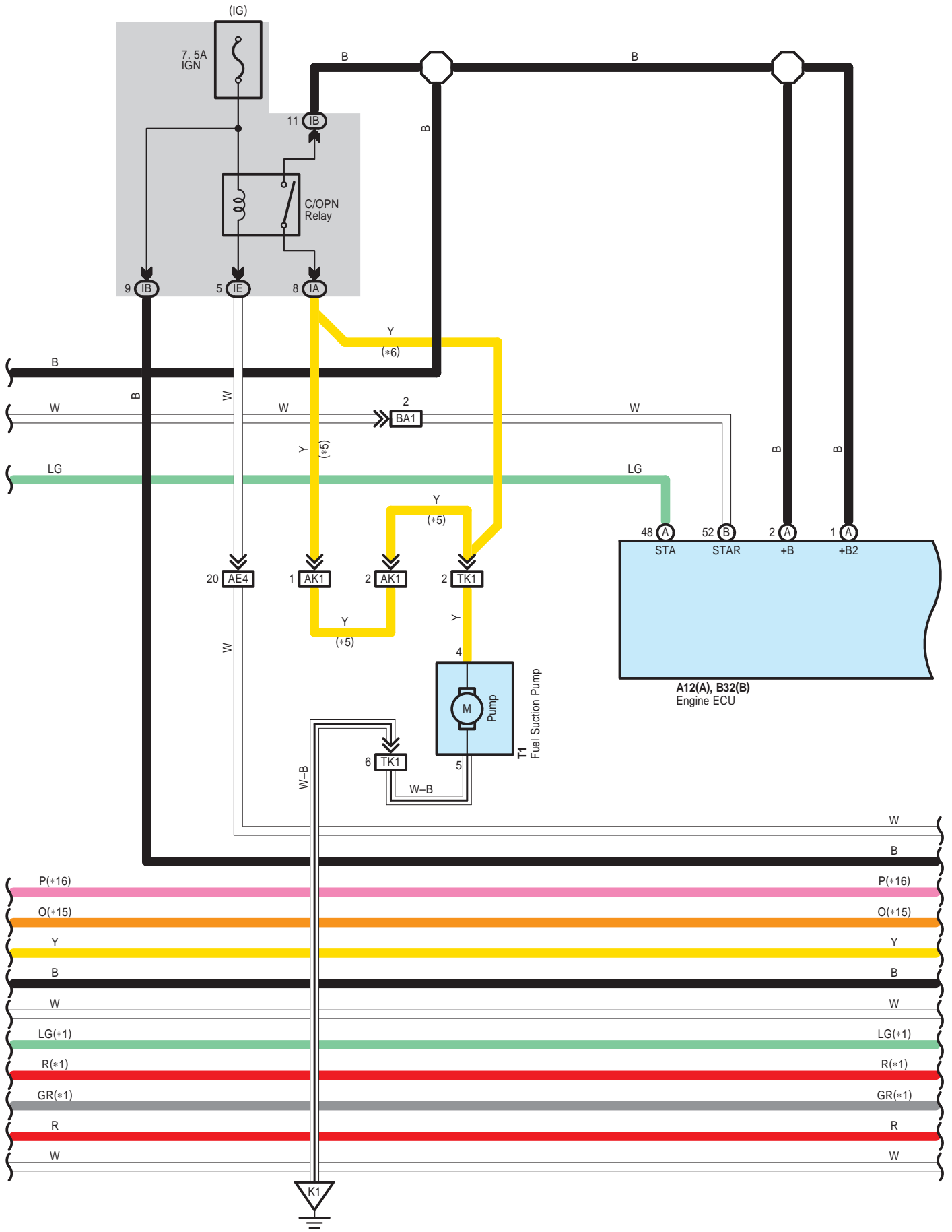

Engine Control <2AZ-FE, 1AZ-FE>

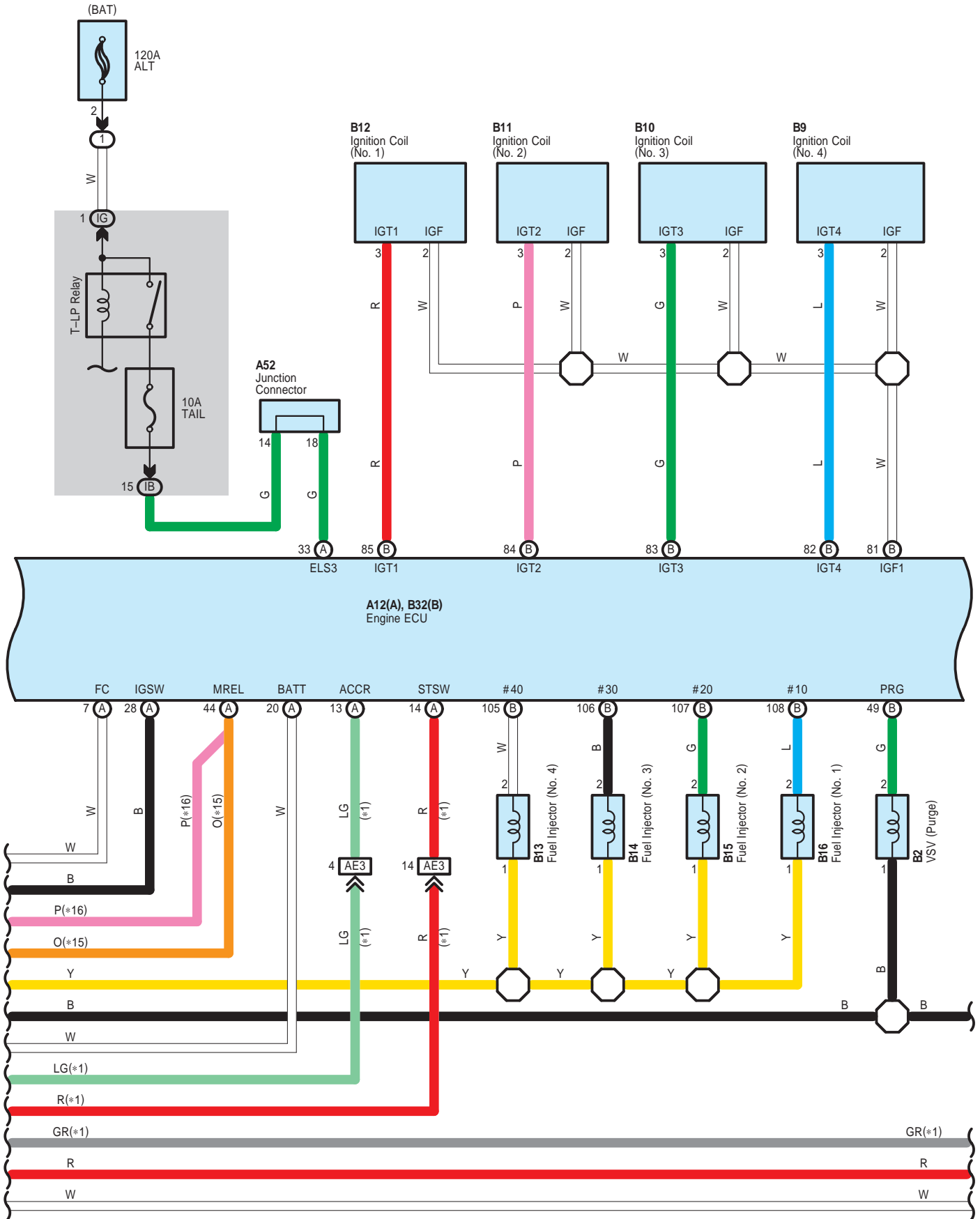

**Engine Control <2AZ-FE, 1AZ-FE>**

- \* 1 : w/ Entry & Start System
- \* 7 : Shielded
- \*15 : Before Aug. 2008 Production Except Europe, Before Dec. 2008 Production Europe
- \*16 : From Aug. 2008 Production Except Europe, From Dec. 2008 Production Europe

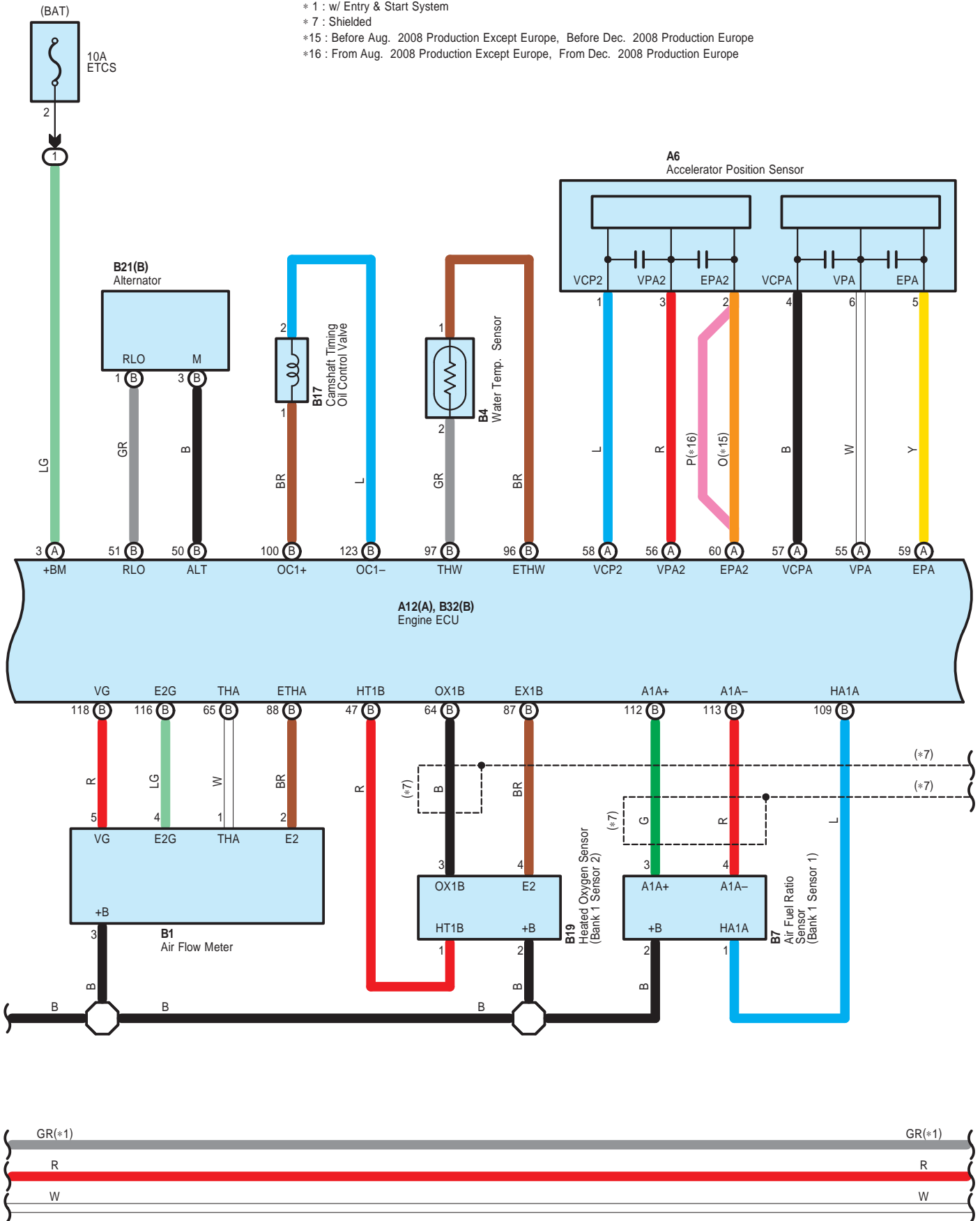

Engine Control <2AZ-FE, 1AZ-FE>

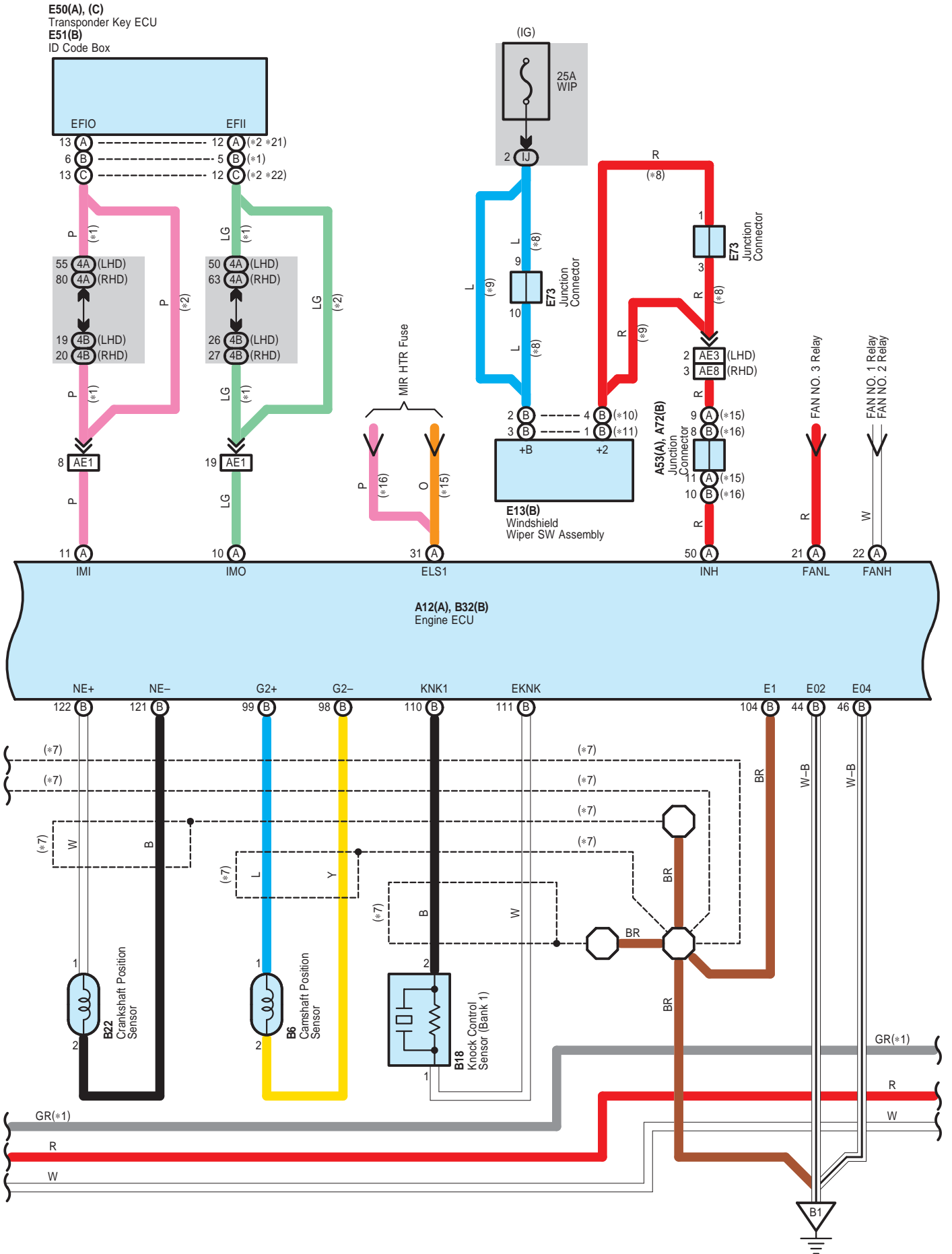

**Engine Control <2AZ-FE, 1AZ-FE>**

- \* 1 : w/ Entry & Start System
- \* 2 : w/o Entry & Start System
- \* 3 : Australia
- \* 4 : RHD Except Australia
- \* 7 : Shielded
- \* 8 : w/ Auto Wiper System
- \* 9 : w/o Auto Wiper System
- \* 10 : RH Wiper Lever Type
- \* 11 : LH Wiper Lever Type
- \* 12 : w/ VSC
- \* 13 : w/o VSC
- \* 15 : Before Aug. 2008 Production Except Europe,  
Before Dec. 2008 Production Europe
- \* 16 : From Aug. 2008 Production Except Europe,  
From Dec. 2008 Production Europe
- \* 21 : Before Aug. 2010 Production
- \* 22 : From Aug. 2010 Production

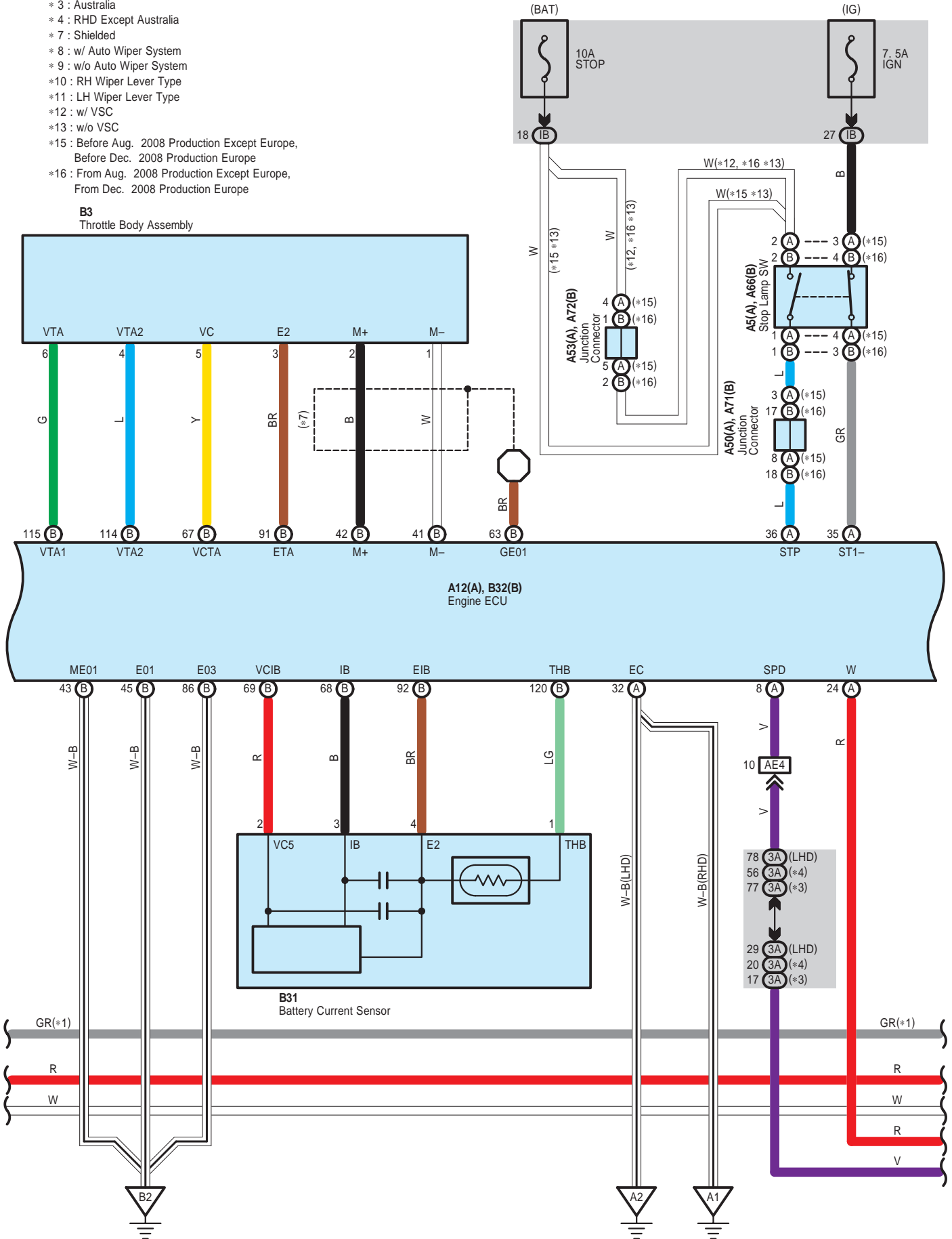



Engine Control <2AZ-FE, 1AZ-FE>

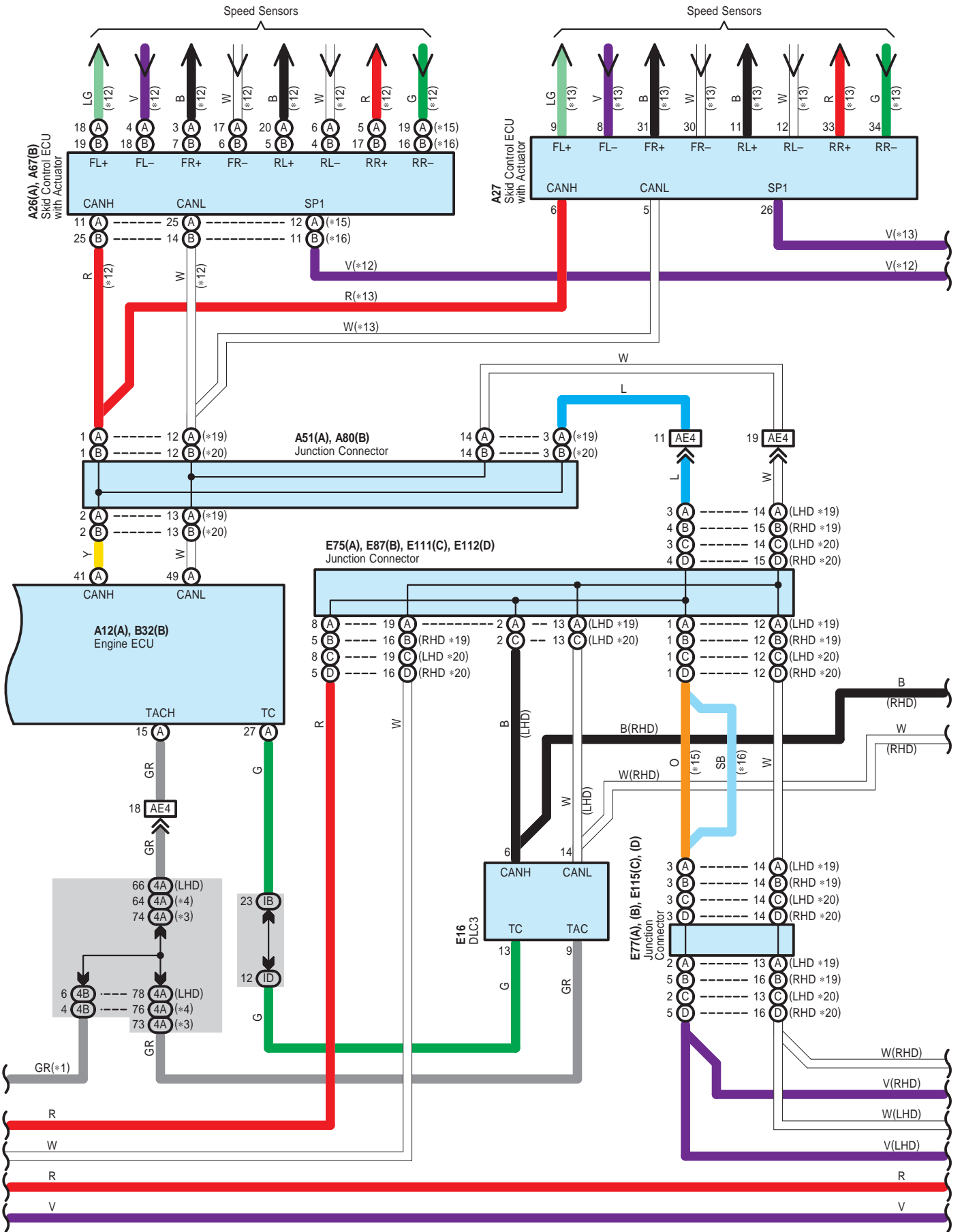

Engine Control <2AZ-FE, 1AZ-FE>

- \* 1 : w/ Entry & Start System
- \* 3 : Australia
- \* 4 : RHD Except Australia
- \*12 : w/ VSC
- \*13 : w/o VSC
- \*14 : Europe
- \*15 : Before Aug. 2008 Production Except Europe,  
Before Dec. 2008 Production Europe
- \*16 : From Aug. 2008 Production Except Europe,  
From Dec. 2008 Production Europe
- \*19 : Before Feb. 2010 Production
- \*20 : From Feb. 2010 Production

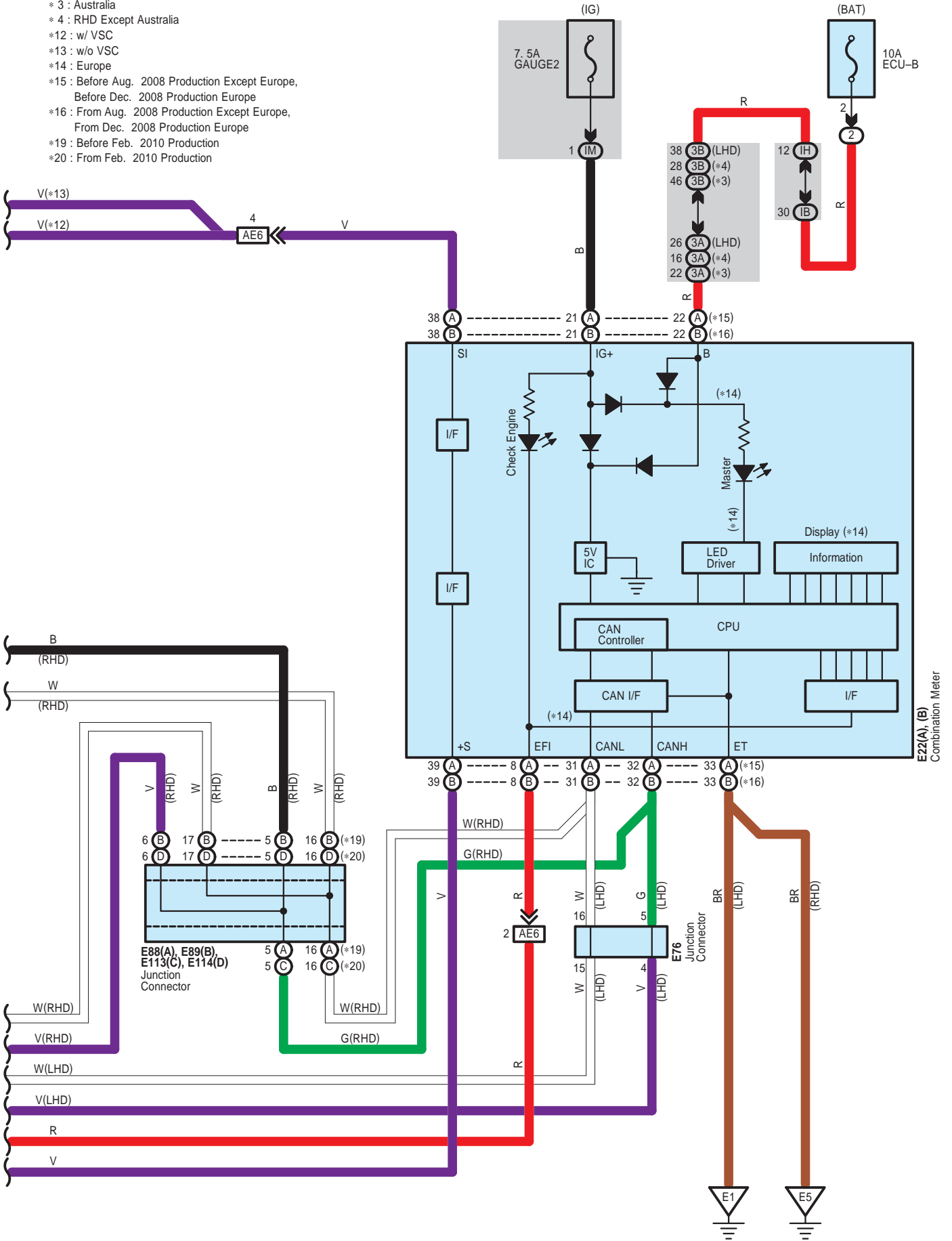

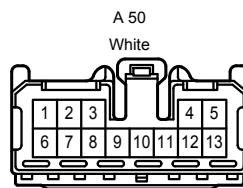
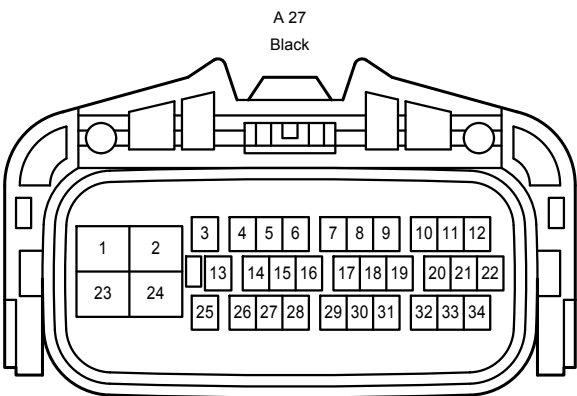
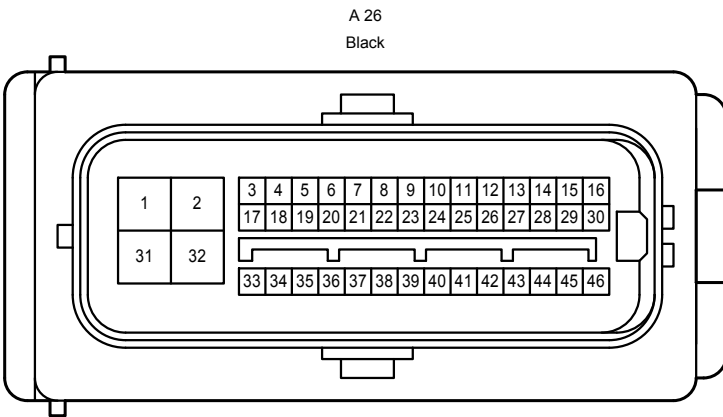
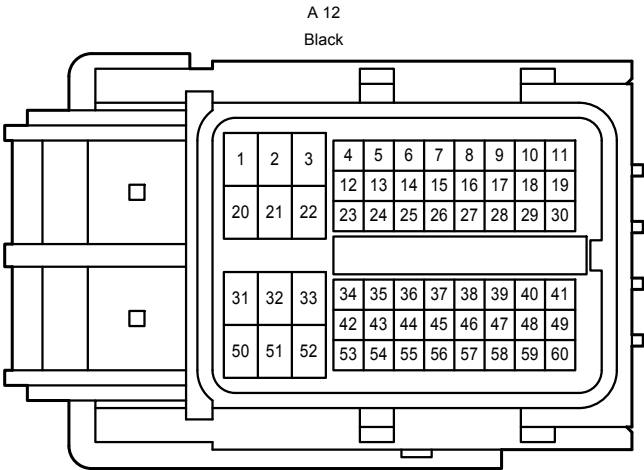
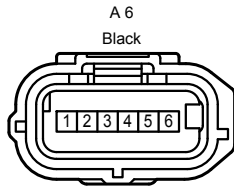
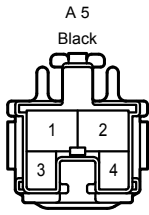
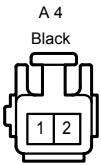

Engine Control <2AZ-FE, 1AZ-FE>

A 51  
Gray

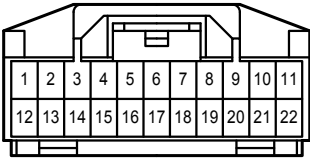

A 52  
Gray

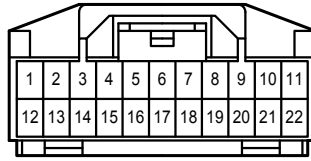

A 53  
Black

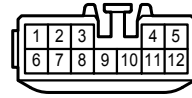

A 66  
White

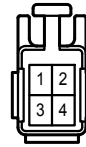

A 67  
Black

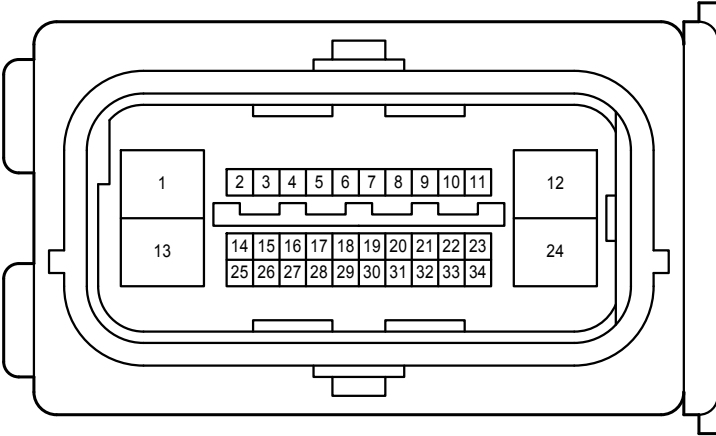

A 71  
White

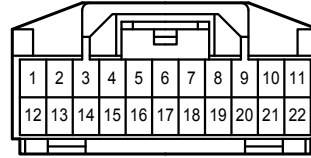

A 72  
Gray

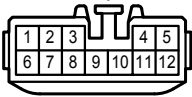

A 80  
Gray

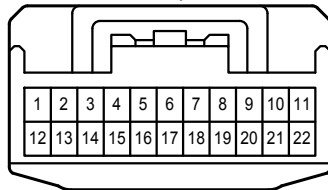

B 1  
Black



B 2  
Blue

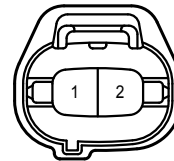

B 3  
Black

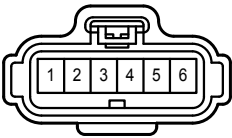

B 4  
Gray



B 6  
Black



B 7  
Dark Gray



B 9  
Gray

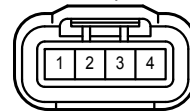

B 10  
Black

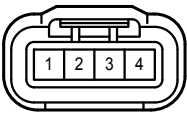

B 11  
Gray

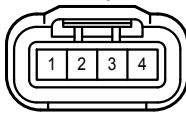

B 12  
Black

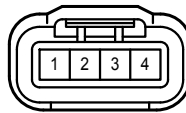

B 13  
Gray

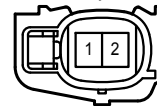

B 14  
Black

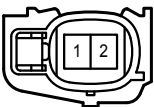

B 15  
Gray

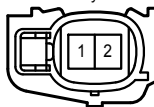

B 16  
Black

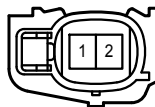

B 17  
Black



B 18  
Black

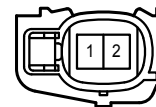

Engine Control <2AZ-FE, 1AZ-FE>

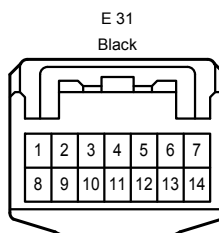
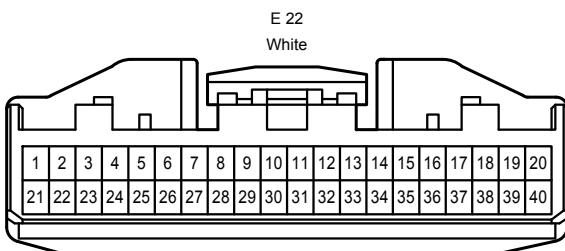
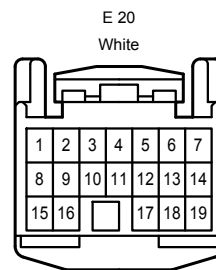
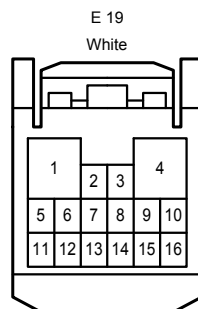
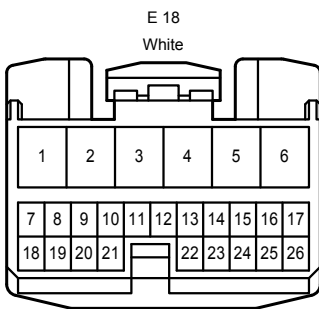
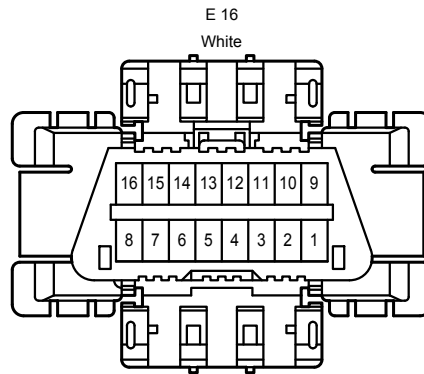
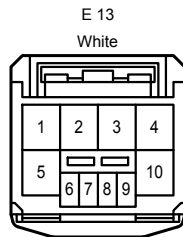
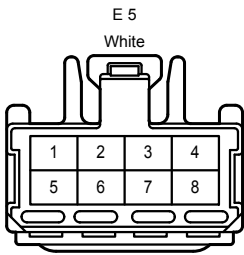
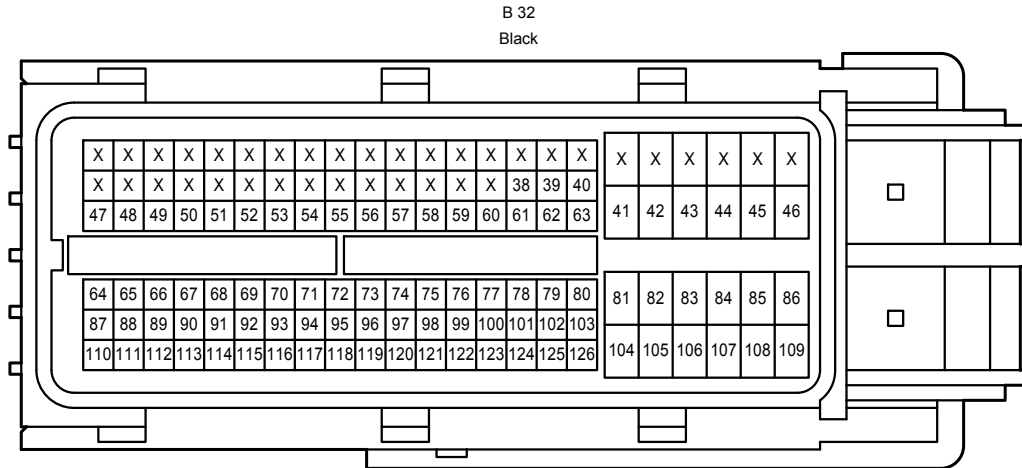
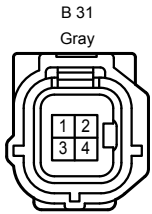
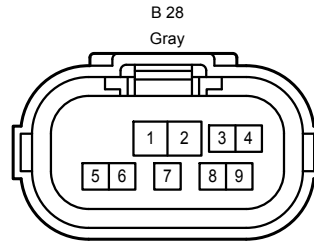
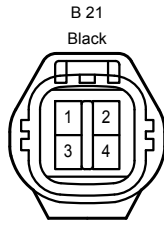

E 50  
White

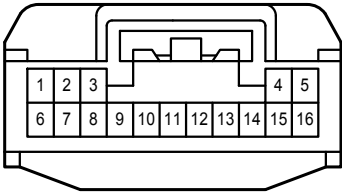

(Before Aug. 2010 Production)

E 50  
Black

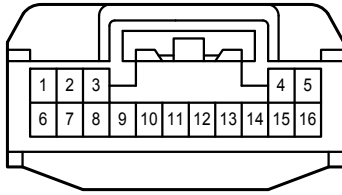

(From Aug. 2010 Production)

E 51  
White

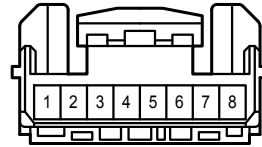

E 73  
Black

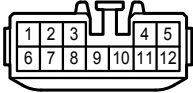

E 75  
Gray

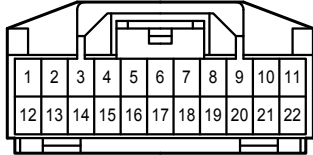

E 76  
Black

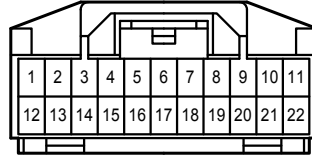

E 77  
Gray

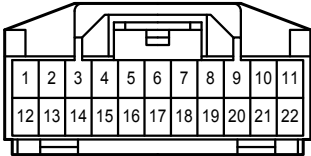

E 87  
Gray

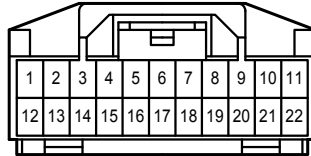

E 88  
Blue

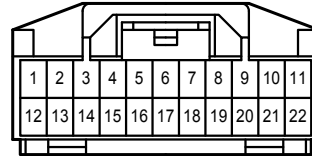

E 89  
Blue

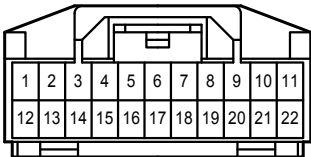

E111  
Gray

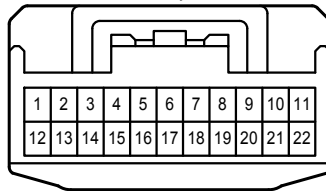

E112  
Gray

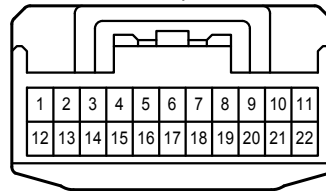

E113  
Black

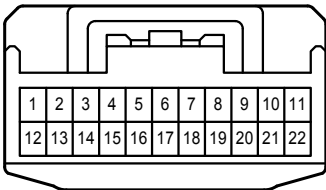

E114  
Black

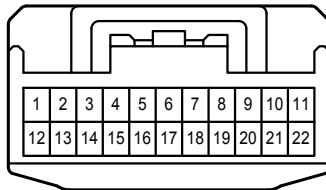

E115  
Gray

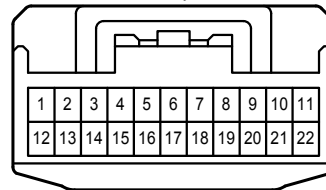

T 1  
White



1A  
White

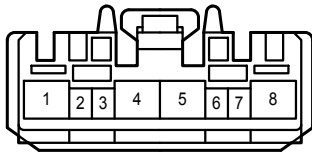

3A  
White

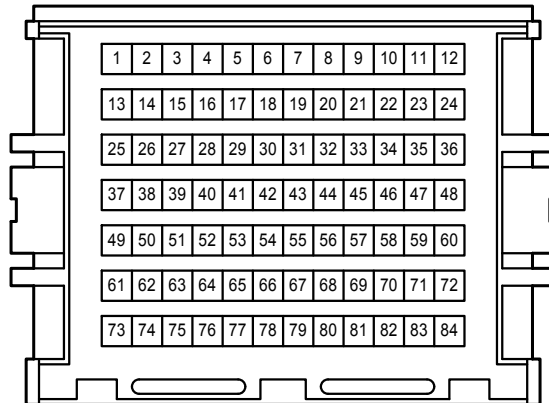

3B  
White

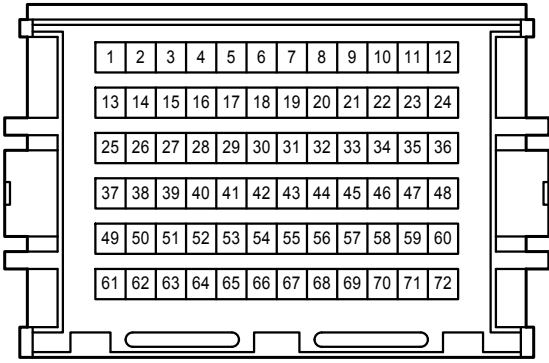

4A  
White

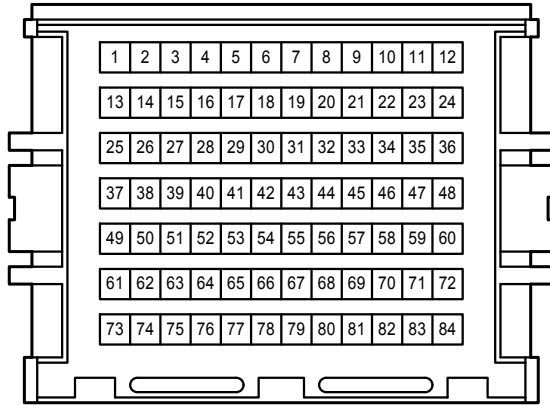

4B  
White

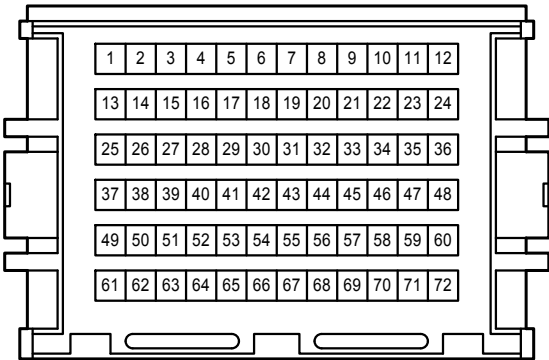

IA  
White

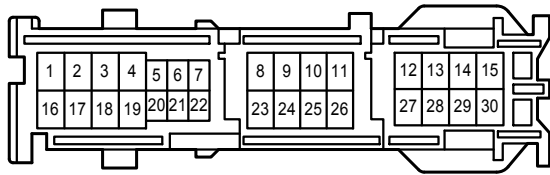

IB  
White

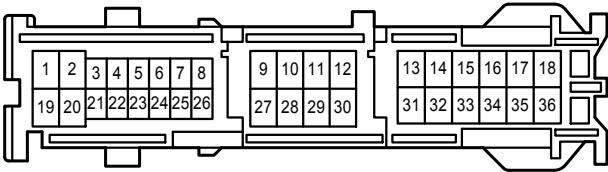

IC  
White

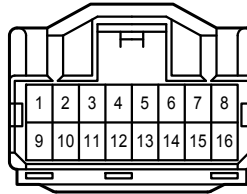

ID  
White

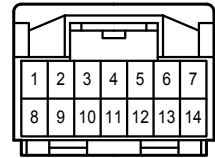

IE  
White

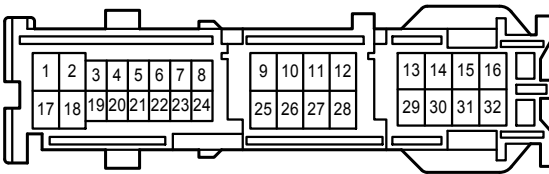

IF  
White

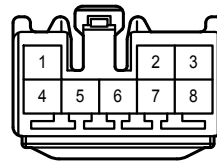

IG  
White

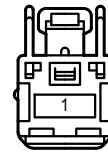

IH  
White

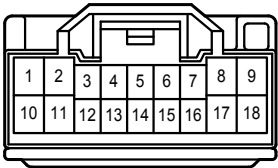

IJ  
White

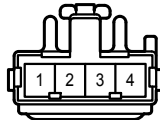

IM  
White

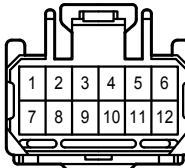

AE1  
White

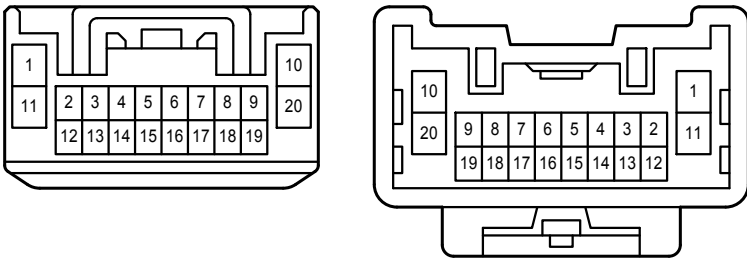

AE2  
White

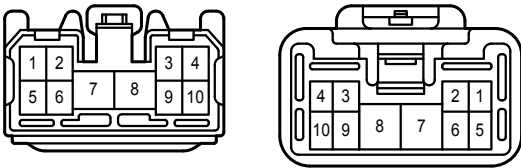

AE3  
Black

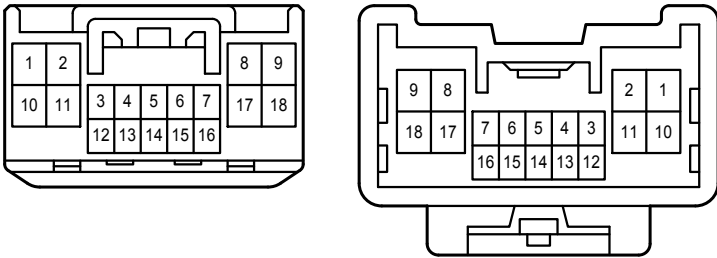

AE4  
Gray

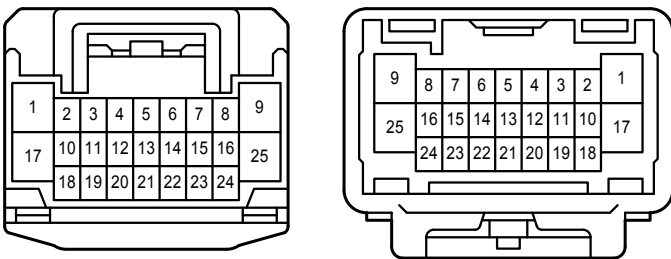

AE6  
White

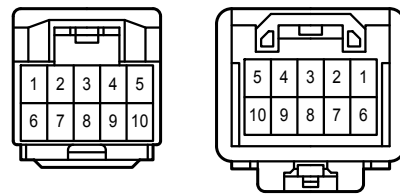

AE8  
White

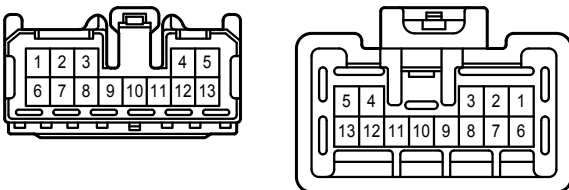



AK1  
White

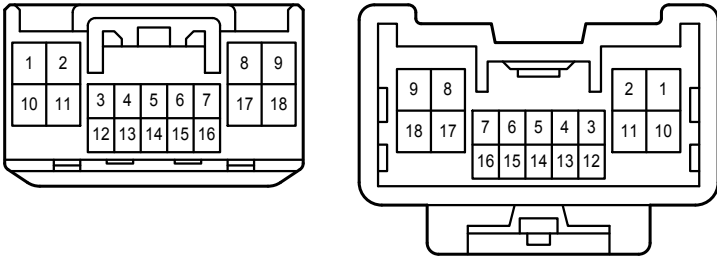

BA1  
White

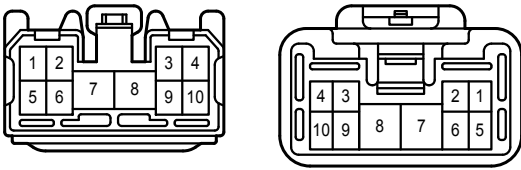

BA2  
Gray

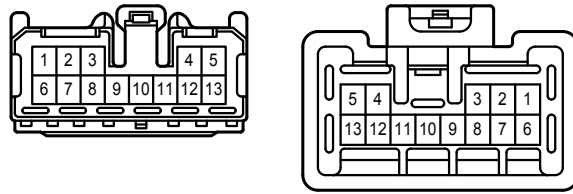

TK1  
White

