

Engine Control <2GR-FE>

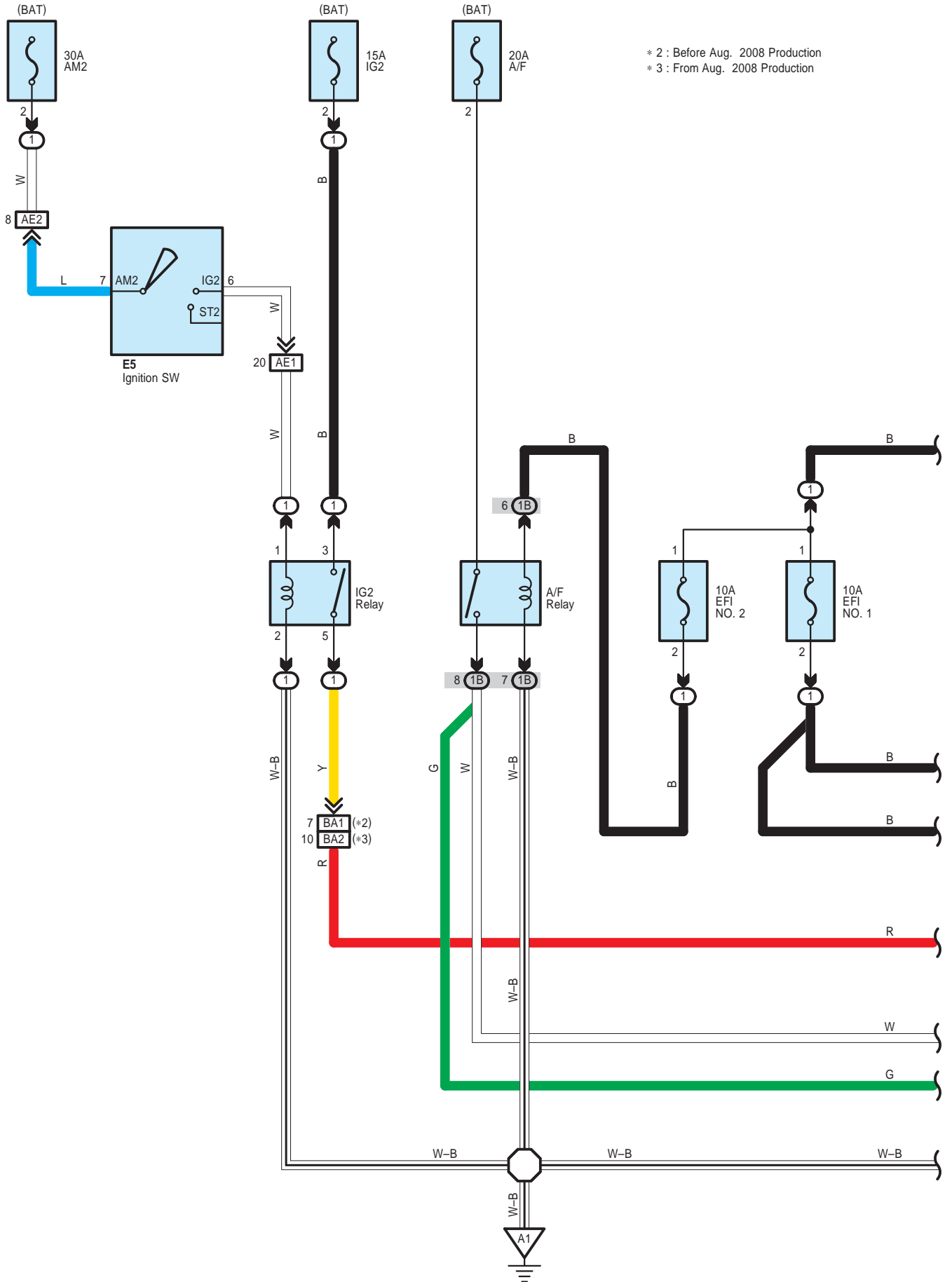

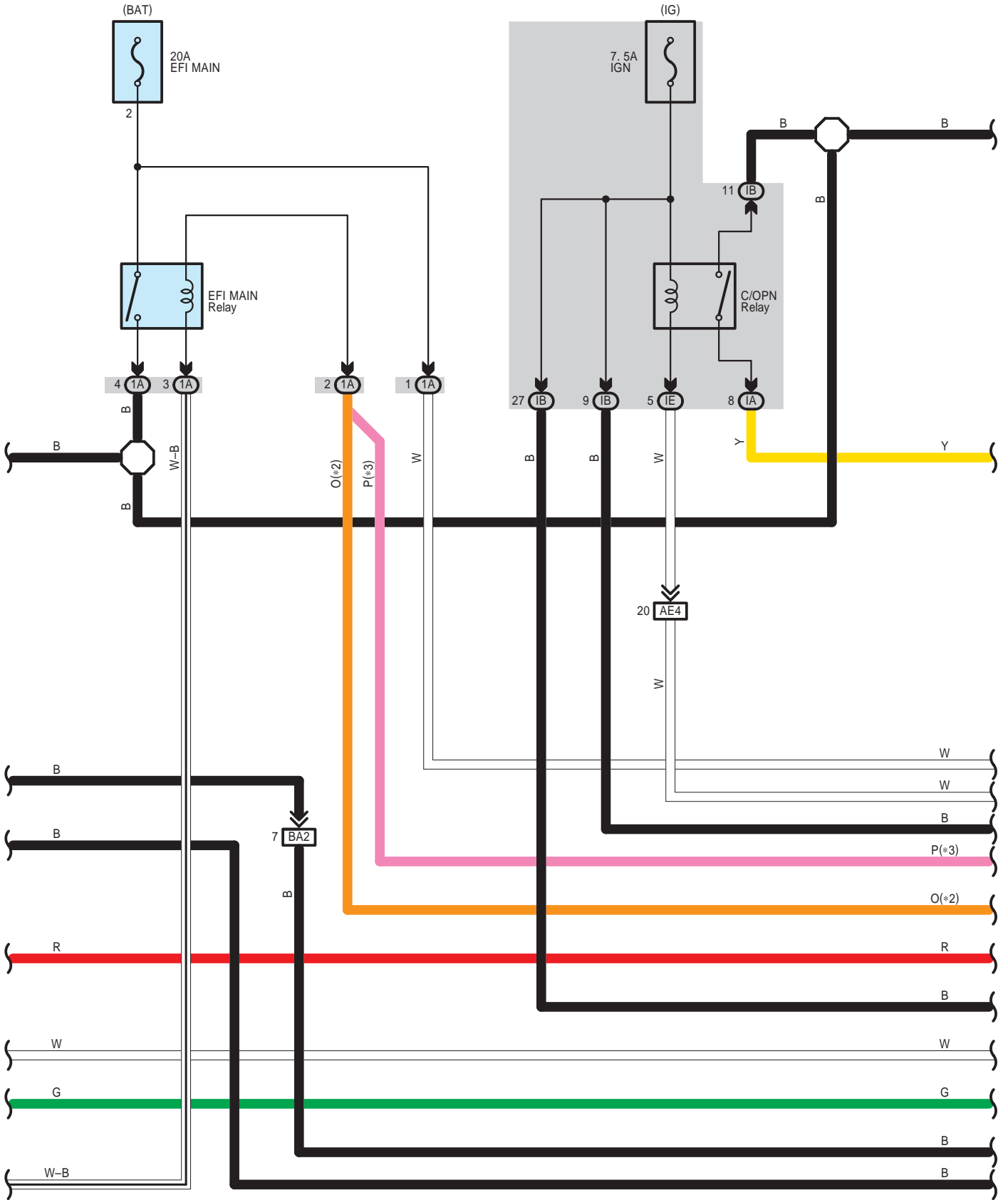

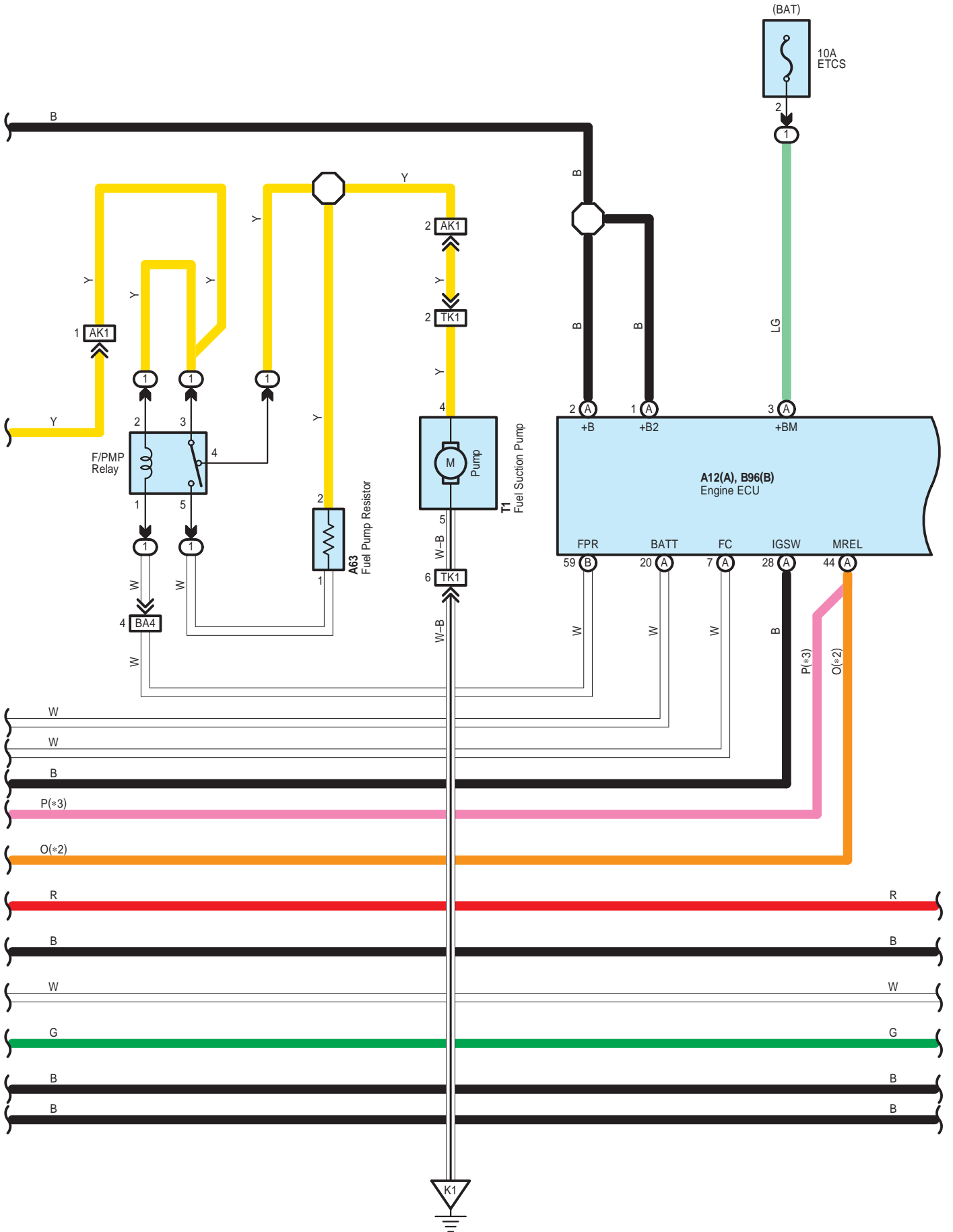

* 2 : Before Aug. 2008 Production
 * 3 : From Aug. 2008 Production

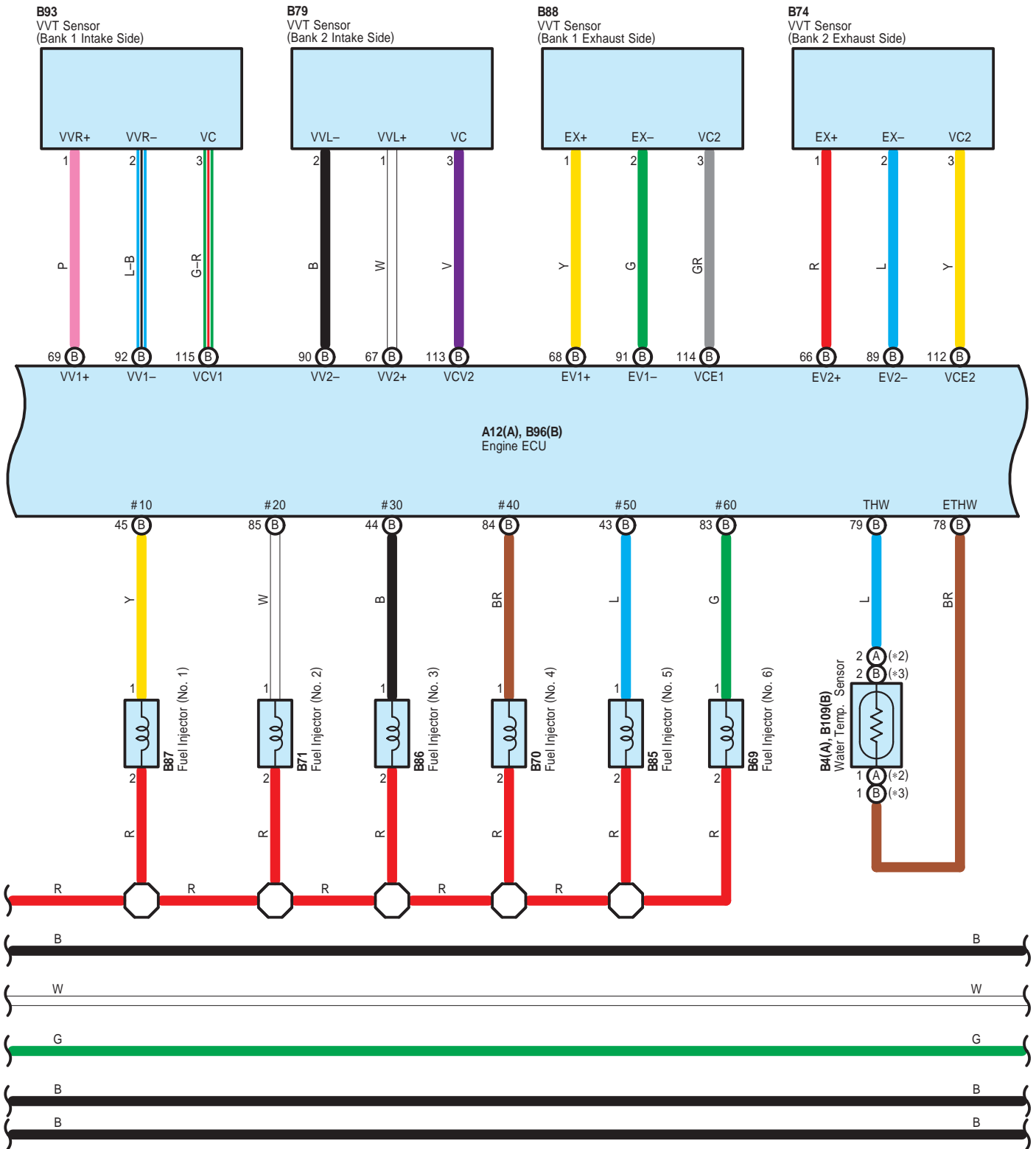

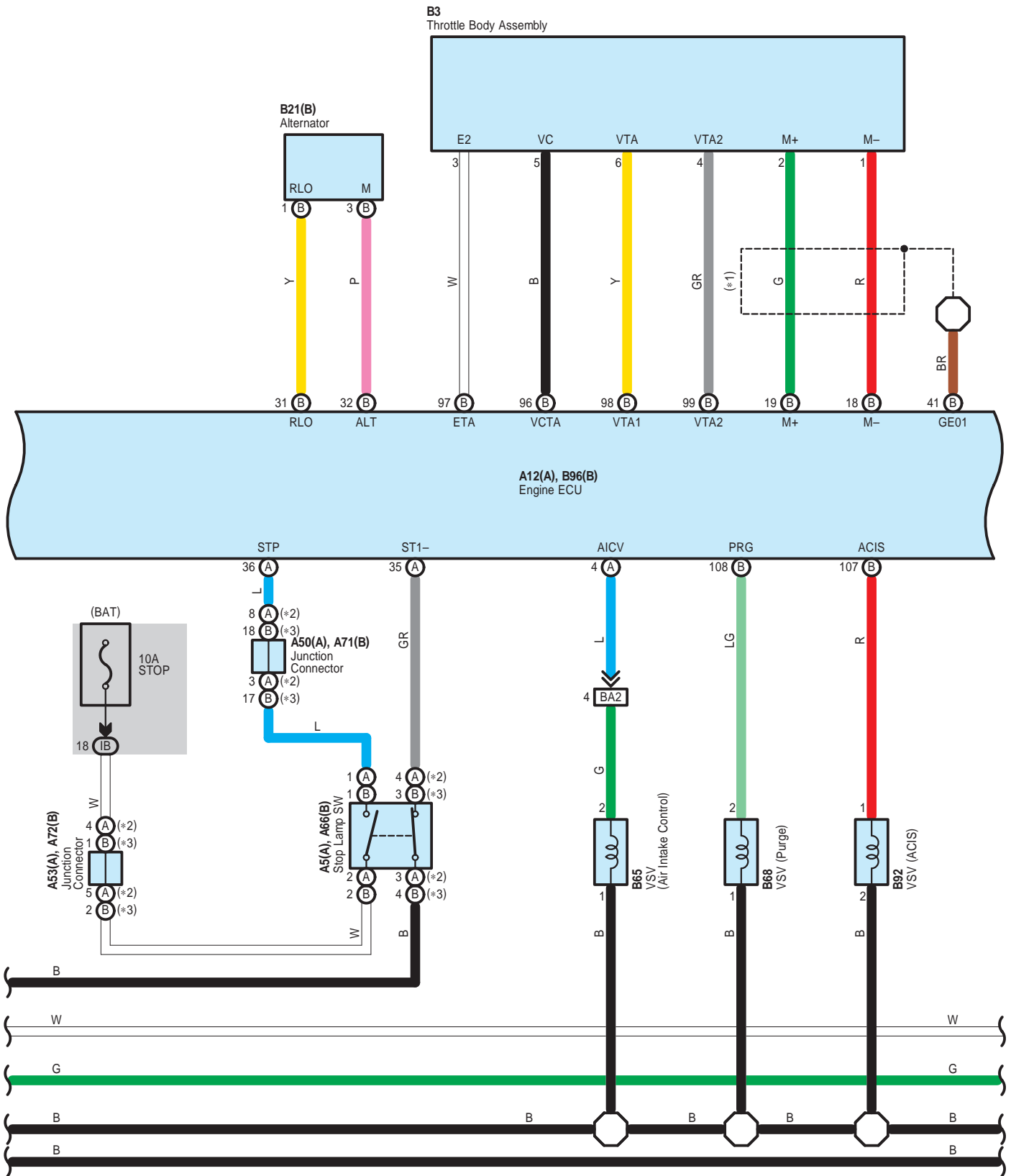

Engine Control <2GR-FE>

- * 1 : Shielded
- * 2 : Before Aug. 2008 Production
- * 3 : From Aug. 2008 Production

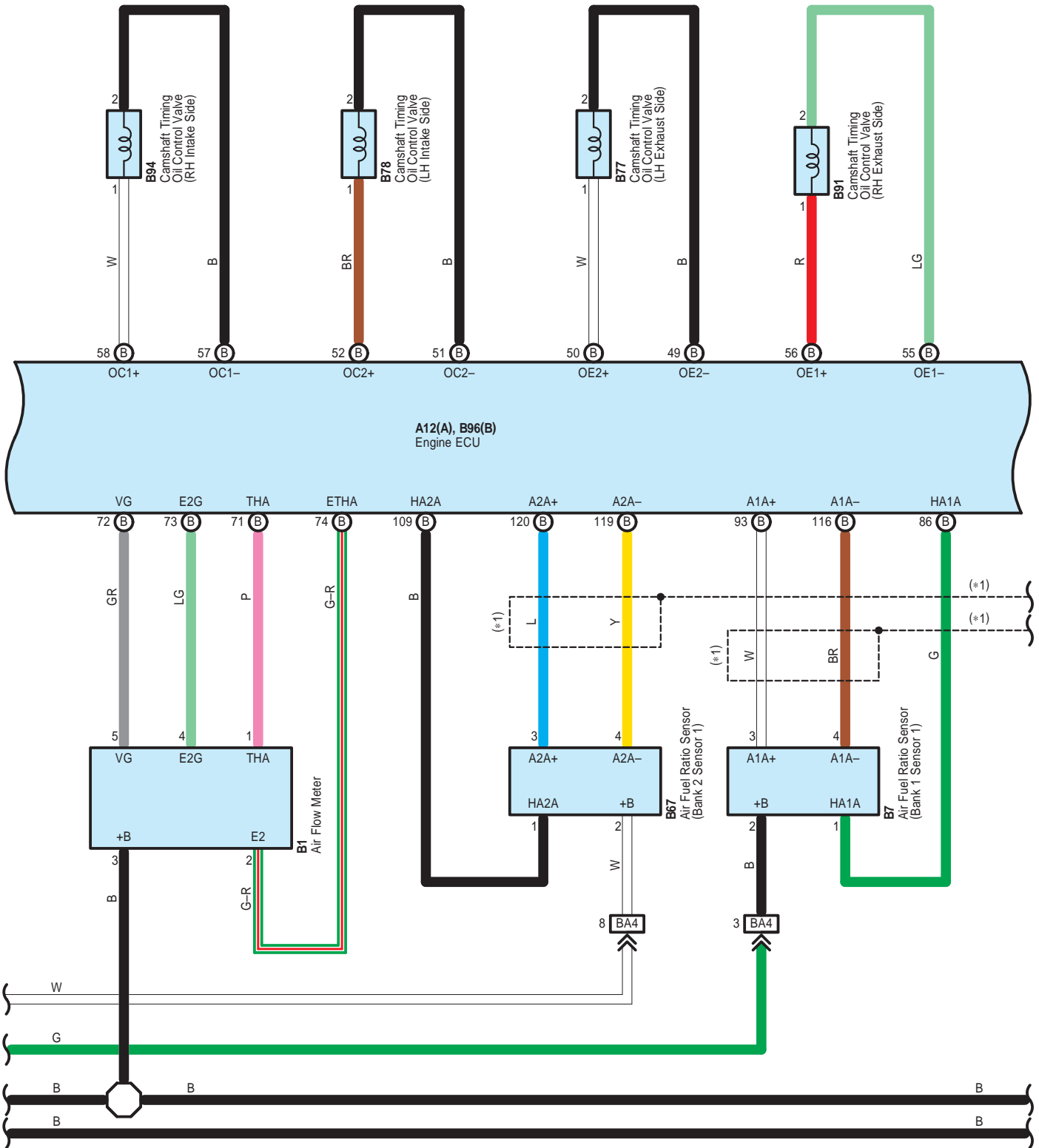

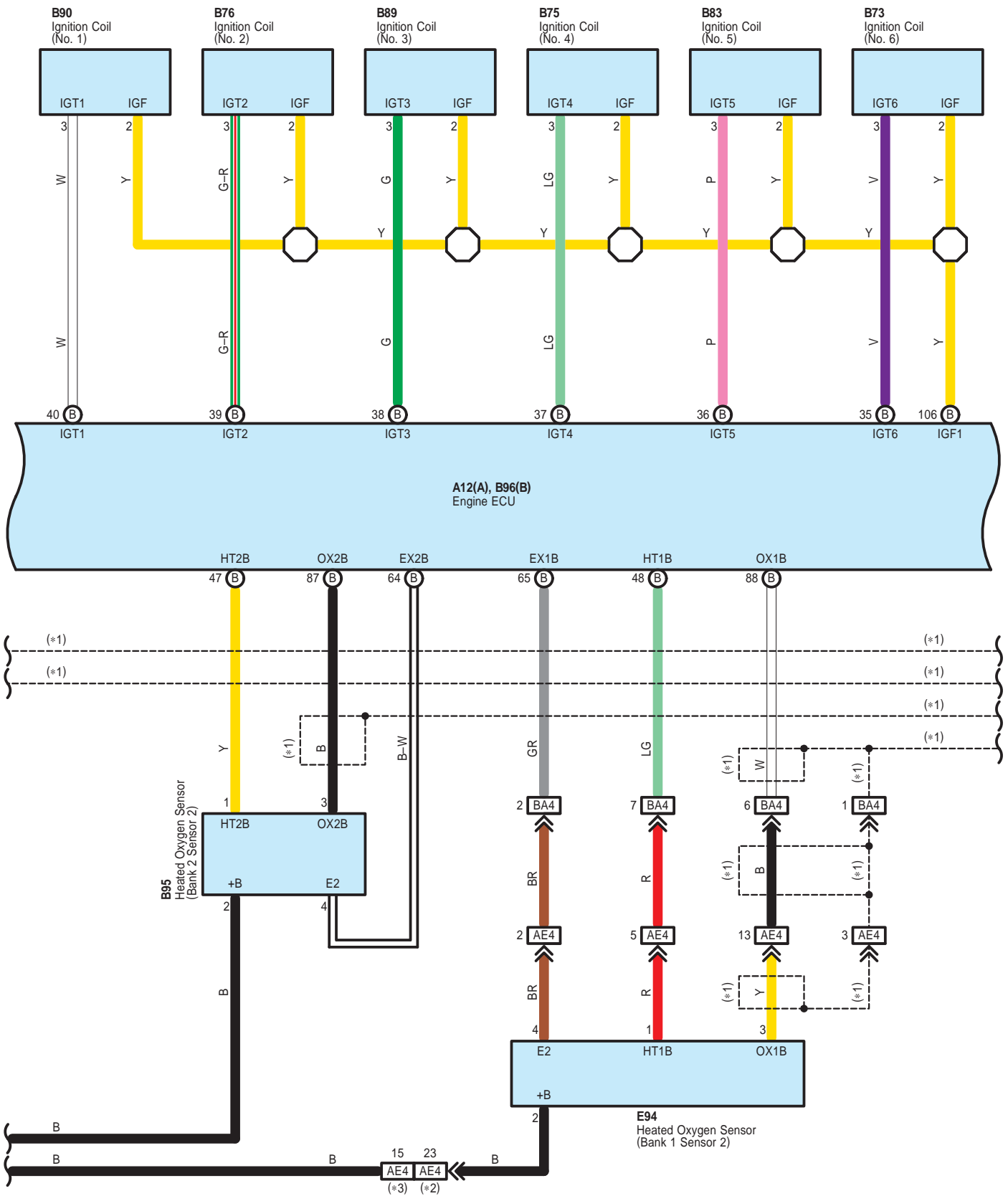

- * 1 : Shielded
- * 2 : Before Aug. 2008 Production
- * 3 : From Aug. 2008 Production

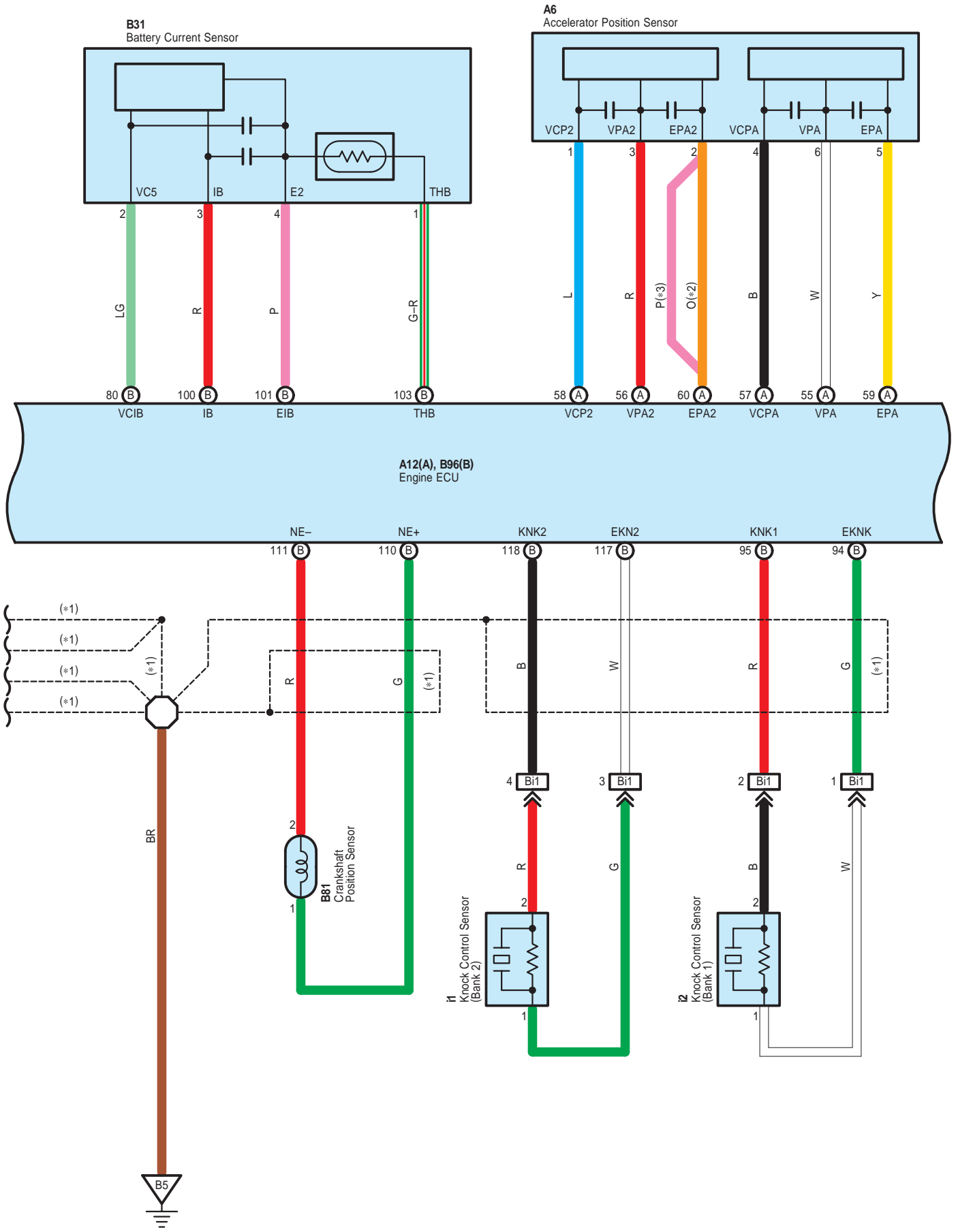

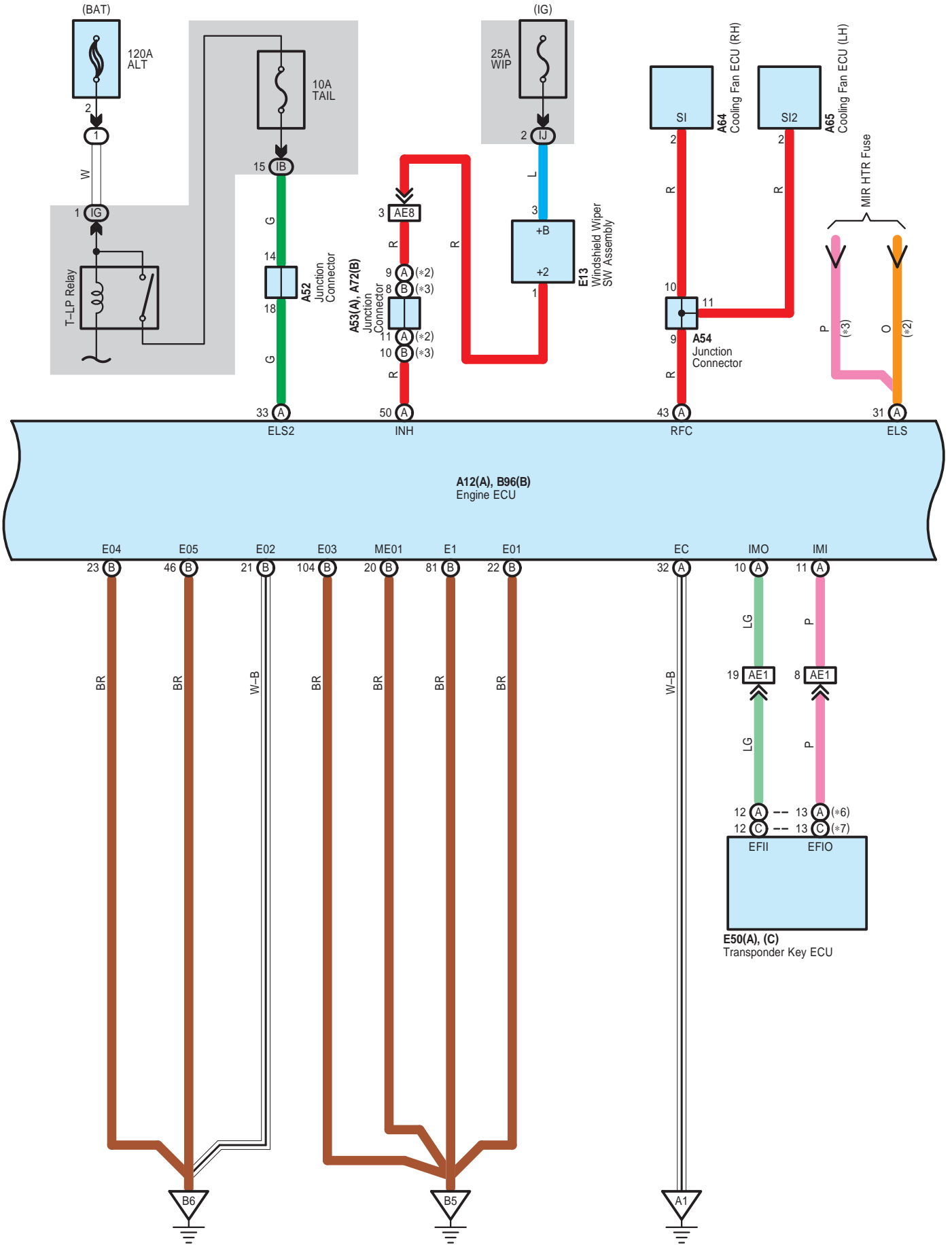

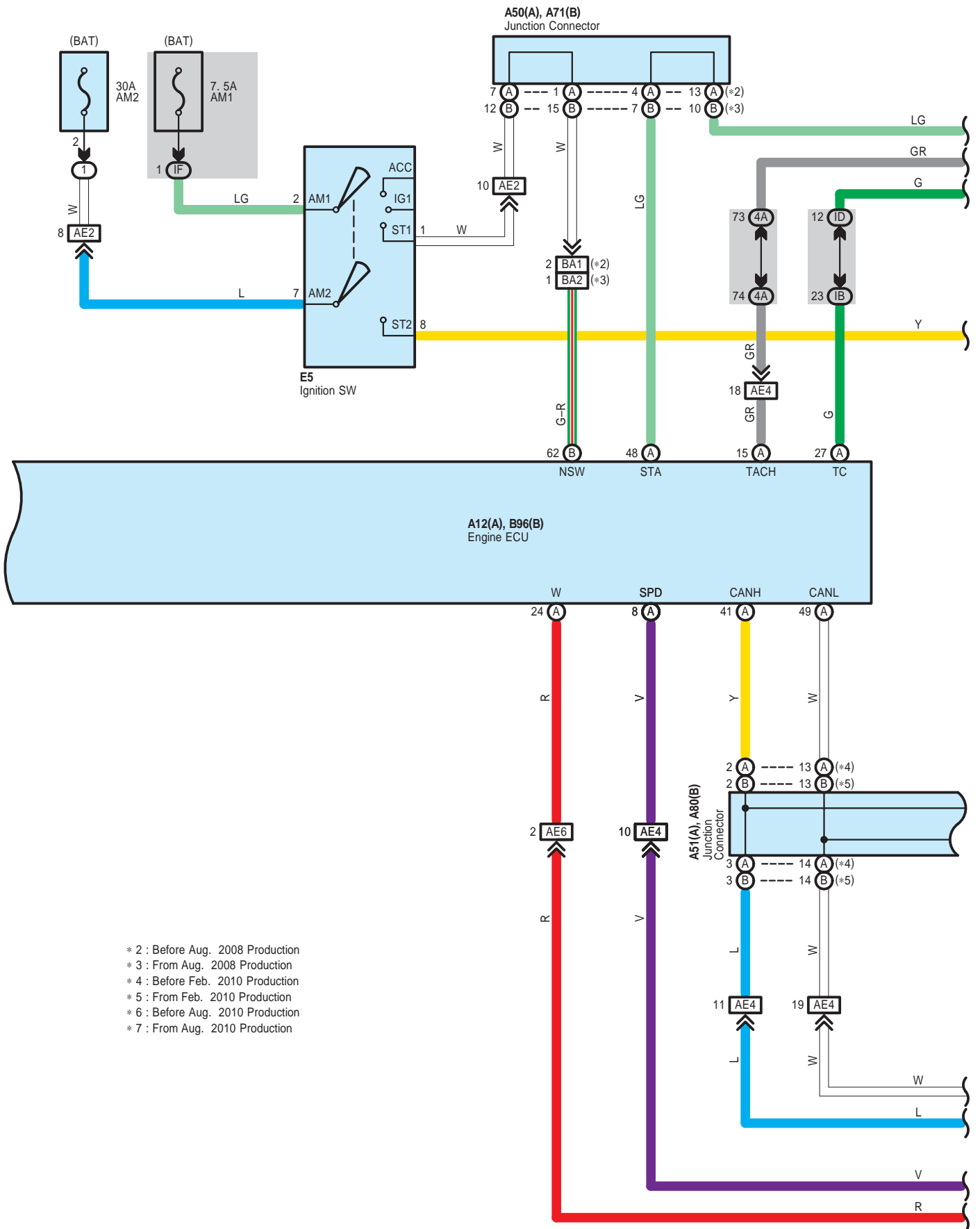

- * 2 : Before Aug. 2008 Production
- * 3 : From Aug. 2008 Production
- * 4 : Before Feb. 2010 Production
- * 5 : From Feb. 2010 Production
- * 6 : Before Aug. 2010 Production
- * 7 : From Aug. 2010 Production

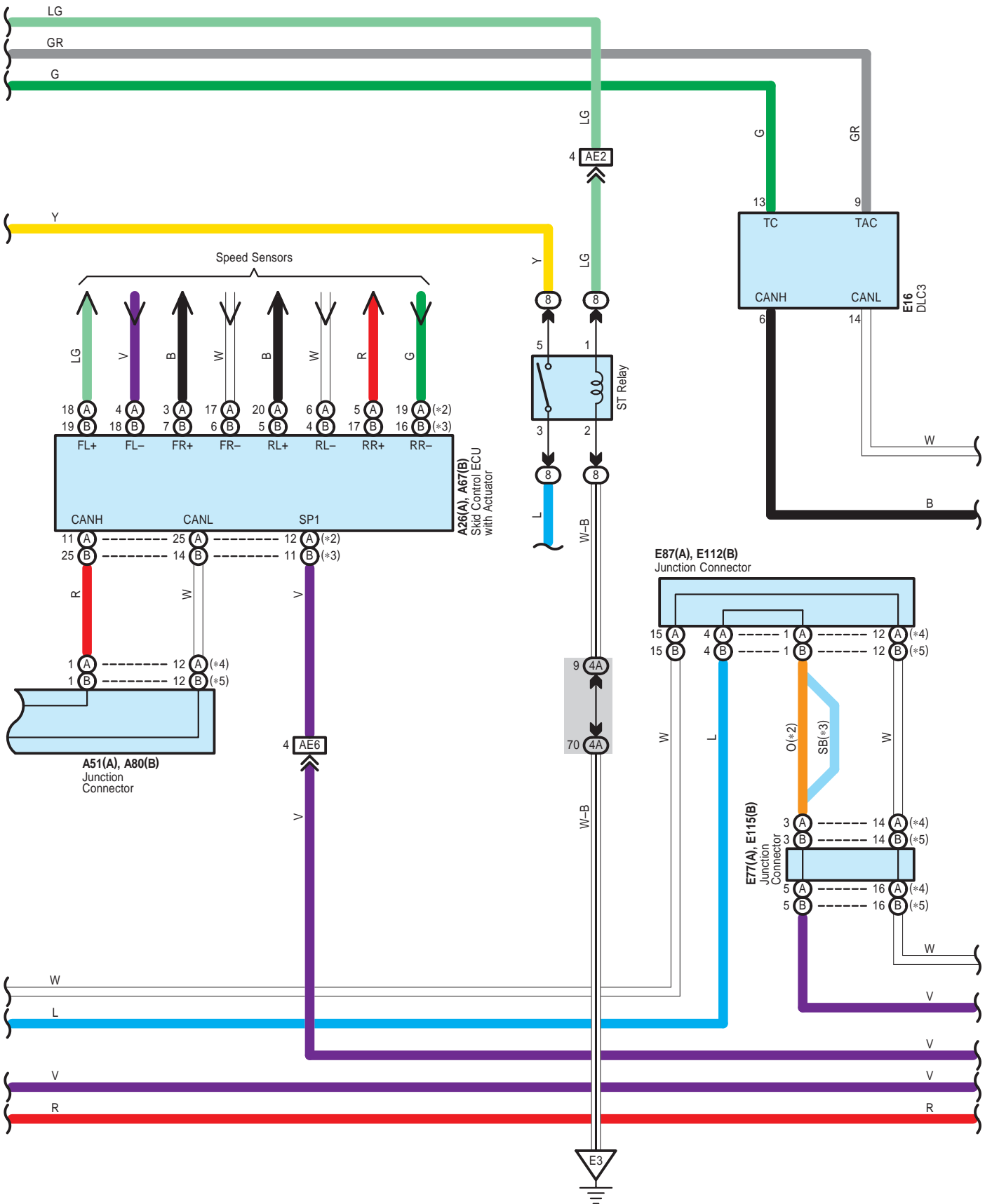

- * 2 : Before Aug. 2008 Production
- * 3 : From Aug. 2008 Production
- * 4 : Before Feb. 2010 Production
- * 5 : From Feb. 2010 Production

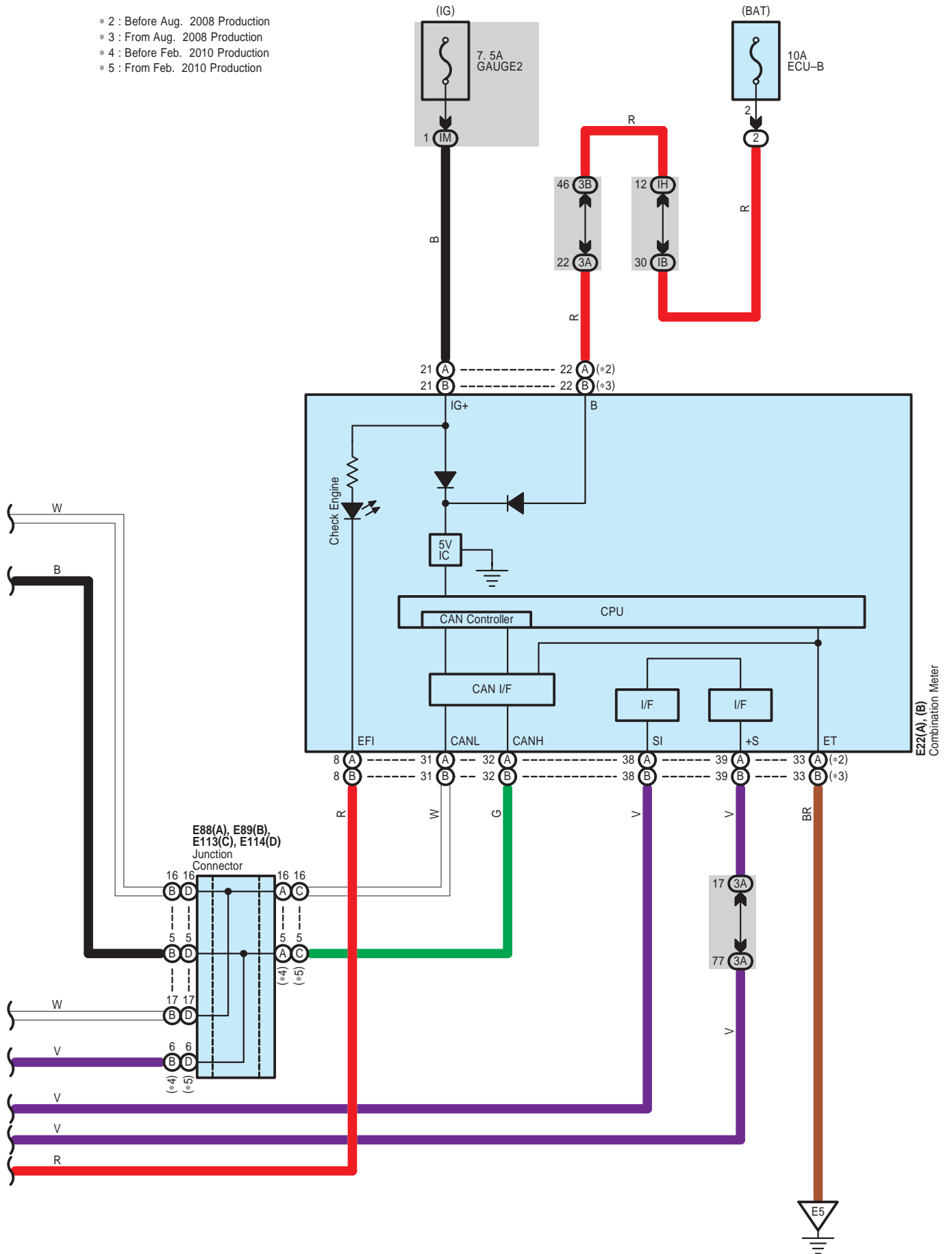

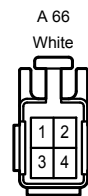
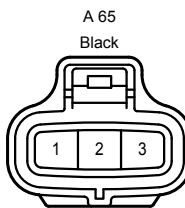
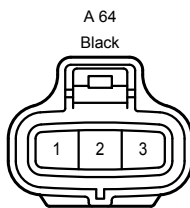
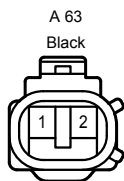
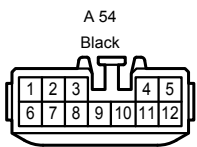
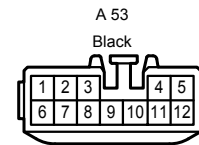
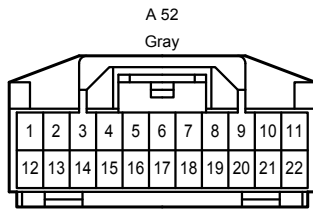
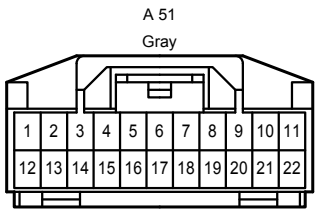
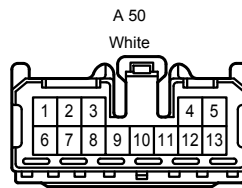
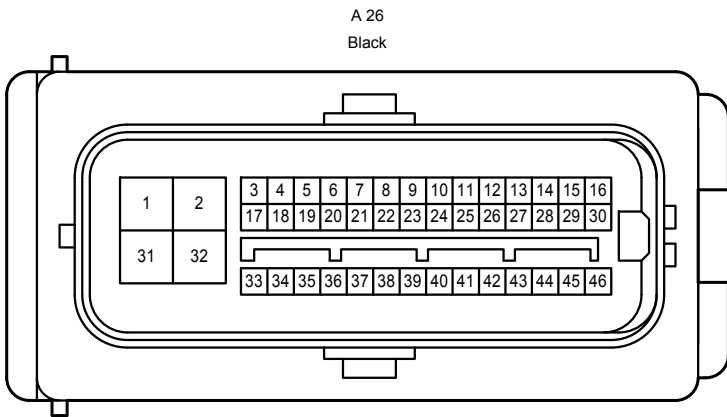
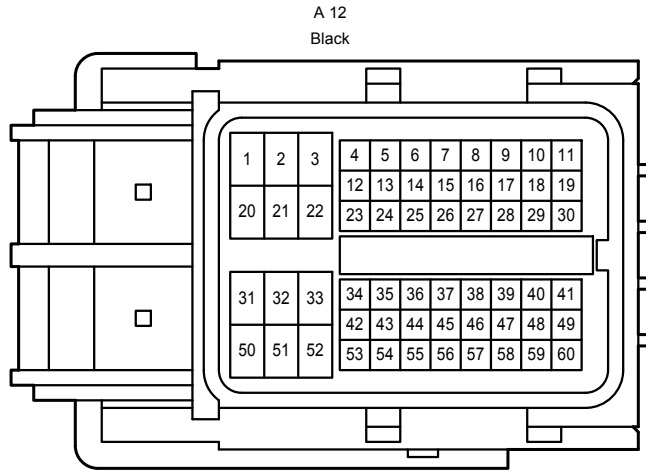
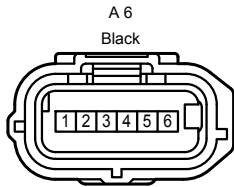
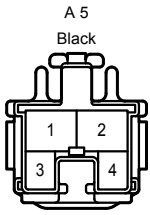

A 67
Black

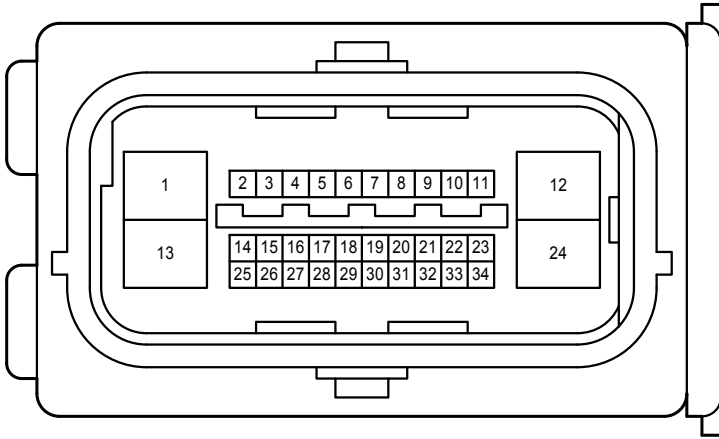

A 71
White

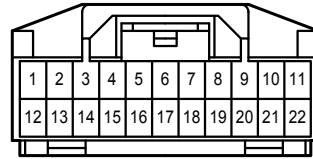

A 72
Gray

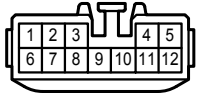

A 80
Gray

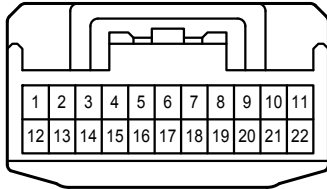

B 1
Black

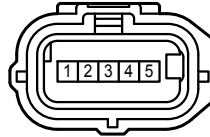

B 3
Black

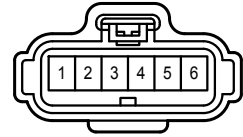

B 4
Gray



B 7
Dark Gray



B 21
Black



B 31
Gray

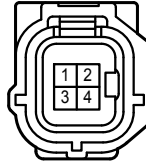

B 65
Black

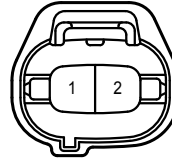

B 67
Dark Gray



B 68
Black

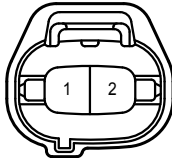

B 69
Gray

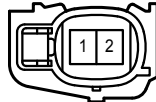

B 70
Black

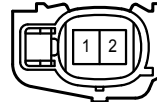

B 71
Gray

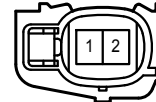

B 73
Black

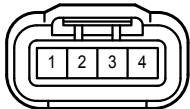

B 74
Black

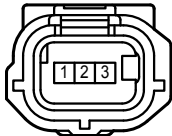

B 75
Brown

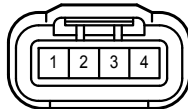

B 76
Black

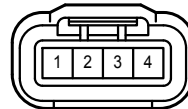

B 77
Black



B 78
Black



B 79
Black



B 81
Black

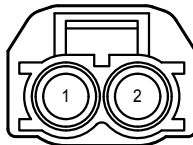

B 83
Black

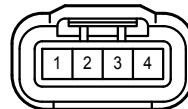

B 85
Gray

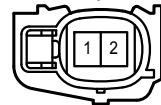

Engine Control <2GR-FE>

B 86
Black

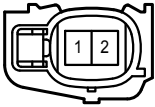

B 87
Gray

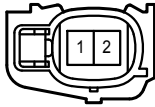

B 88
Black

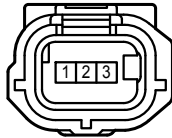

B 89
Brown

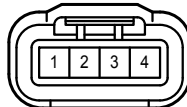

B 90
Black

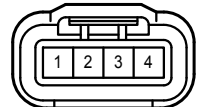

B 91
Black



B 92
Gray



B 93
Black

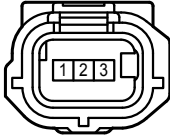

B 94
Black



B 95
Dark Gray



B 96
Black

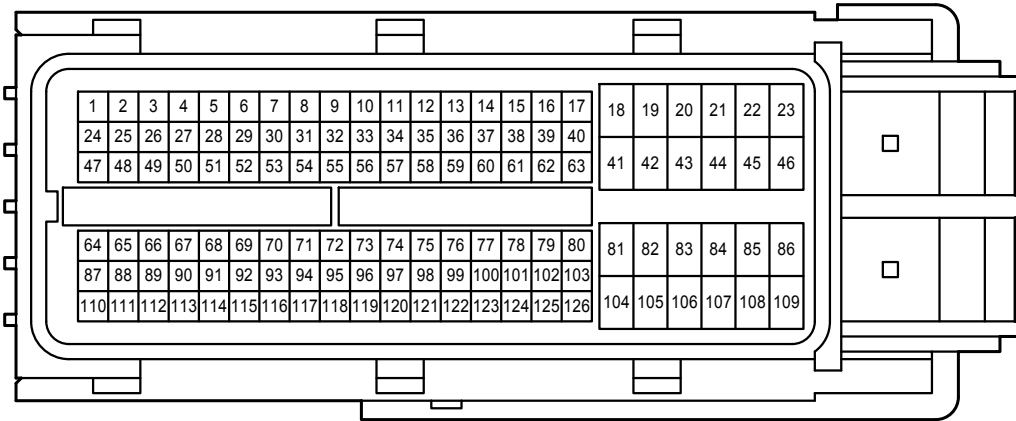

B109
Black



E 5
White

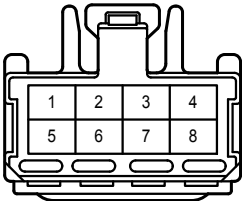

E 13
White

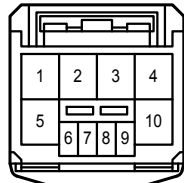

E 16
White

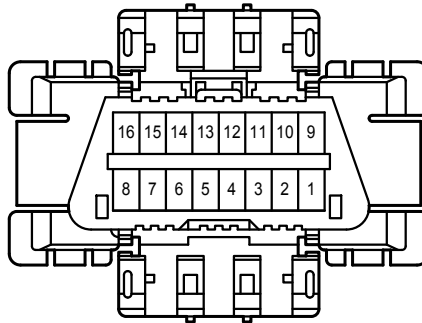

E 22
White

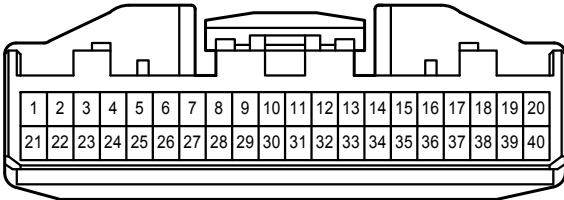

E 50
White

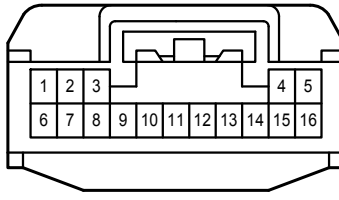

(Before Aug. 2010 Production)

Engine Control <2GR-FE>

E 50
Black

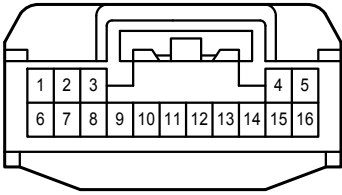

(From Aug. 2010 Production)

E 77
Gray

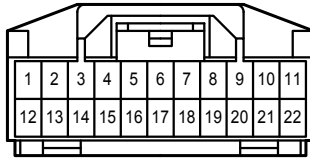

E 87
Gray

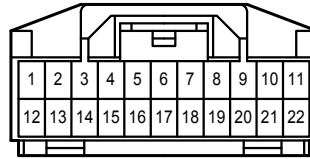

E 88
Blue

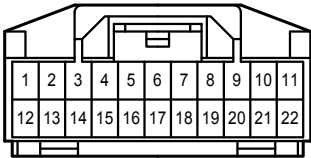

E 89
Blue

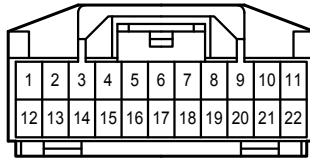

E 94
Gray



E112
Gray

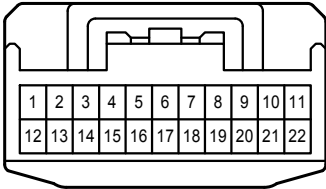

E113
Black

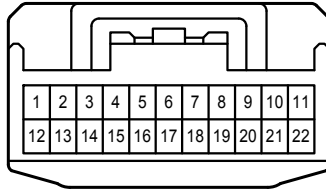

E114
Black

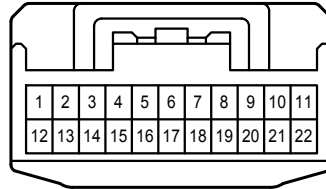

E115
Gray

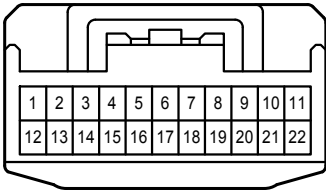

T 1
White



i 1
Gray

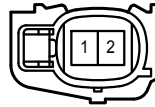

i 2
Black

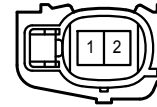

1A
White

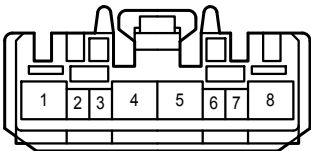

1B
White

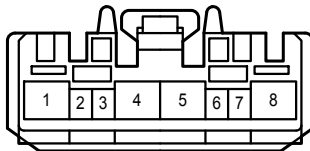

3A
White

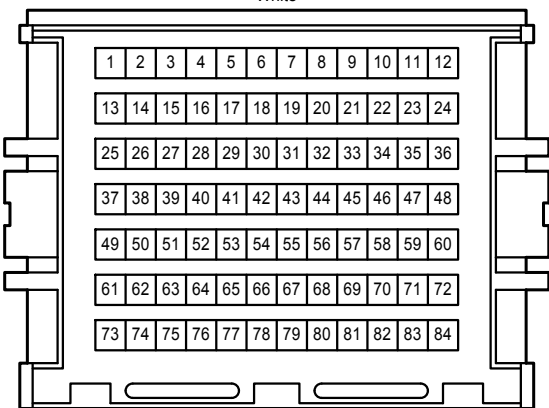

3B
White

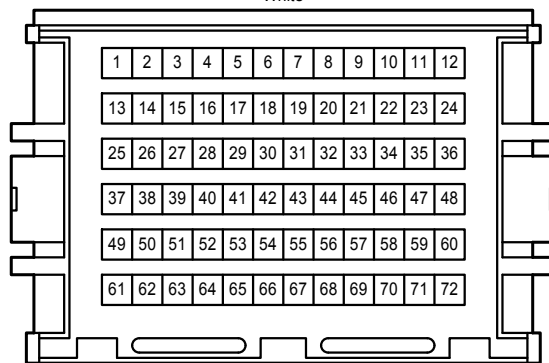

4A
White

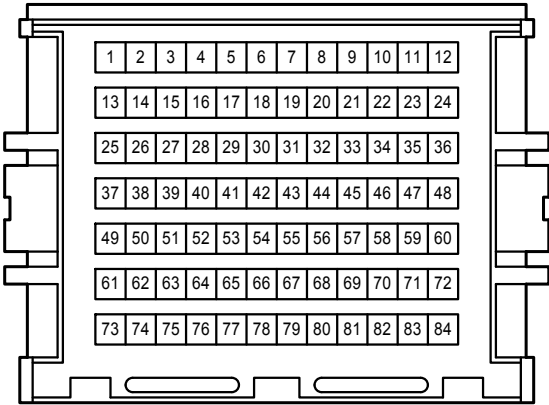

IA
White

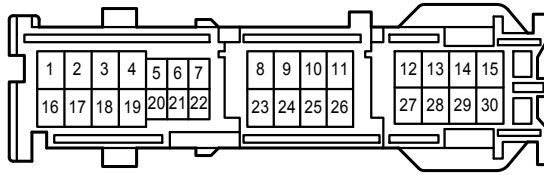

IB
White

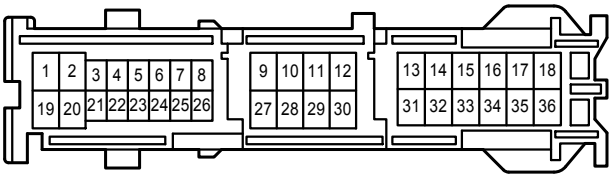

ID
White

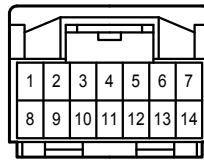

IE
White

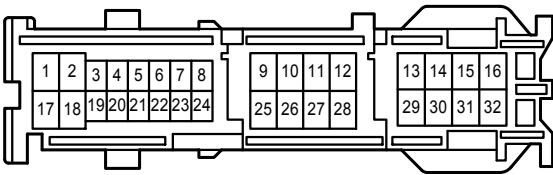

IF
White

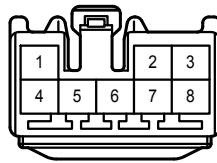

IG
White



IH
White

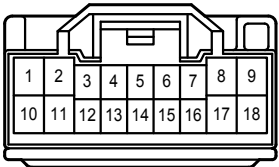

IJ
White

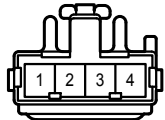

IM
White

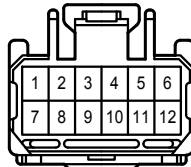

AE1
White

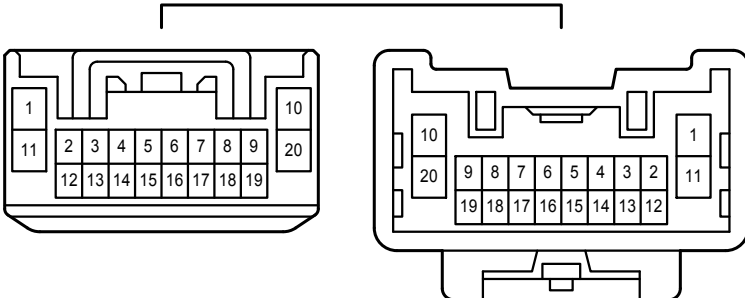

AE2
White

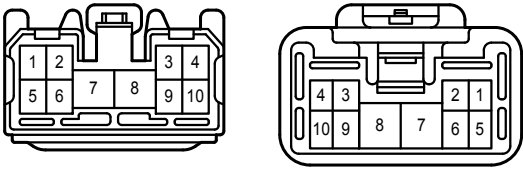

AE4
Gray

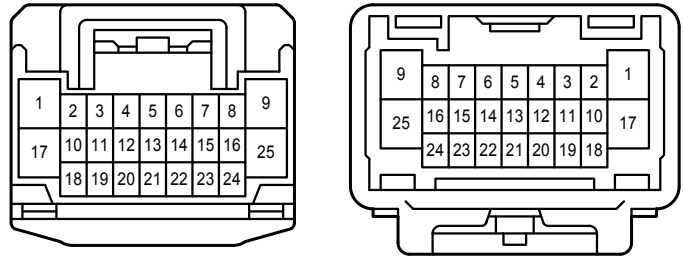

AE6
White

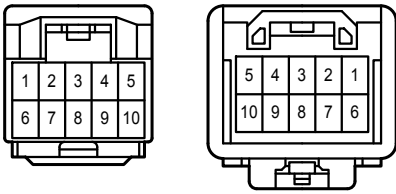

AE8
White

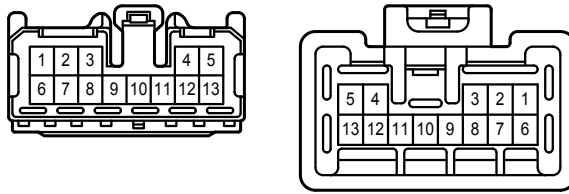

AK1
White

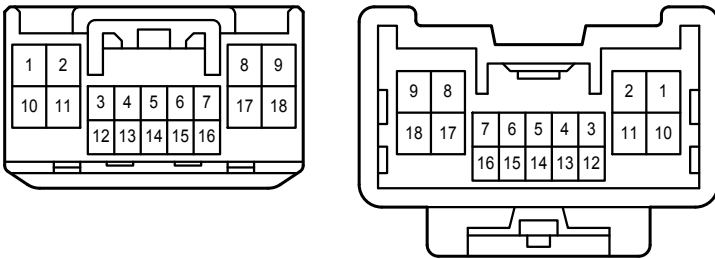

BA1
White

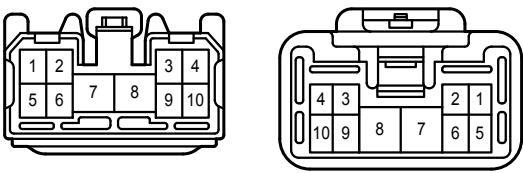

BA2
Gray

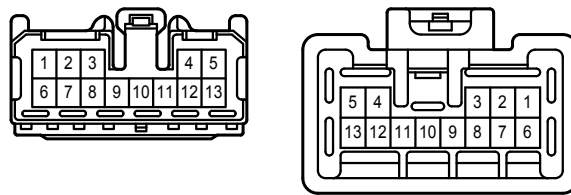

BA4
White

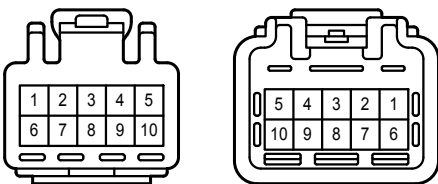

Bi1
Gray

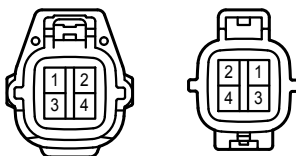

TK1
White

