

- * 1 : Gasoline
- * 2 : Diesel
- *11 : Before Dec. 2008 Production
- *12 : From Dec. 2008 Production
- *13 : 3ZR-FAE
- *14 : Except 3ZR-FAE
- *15 : 3ZR-FAE, Diesel
- *16 : Except *15

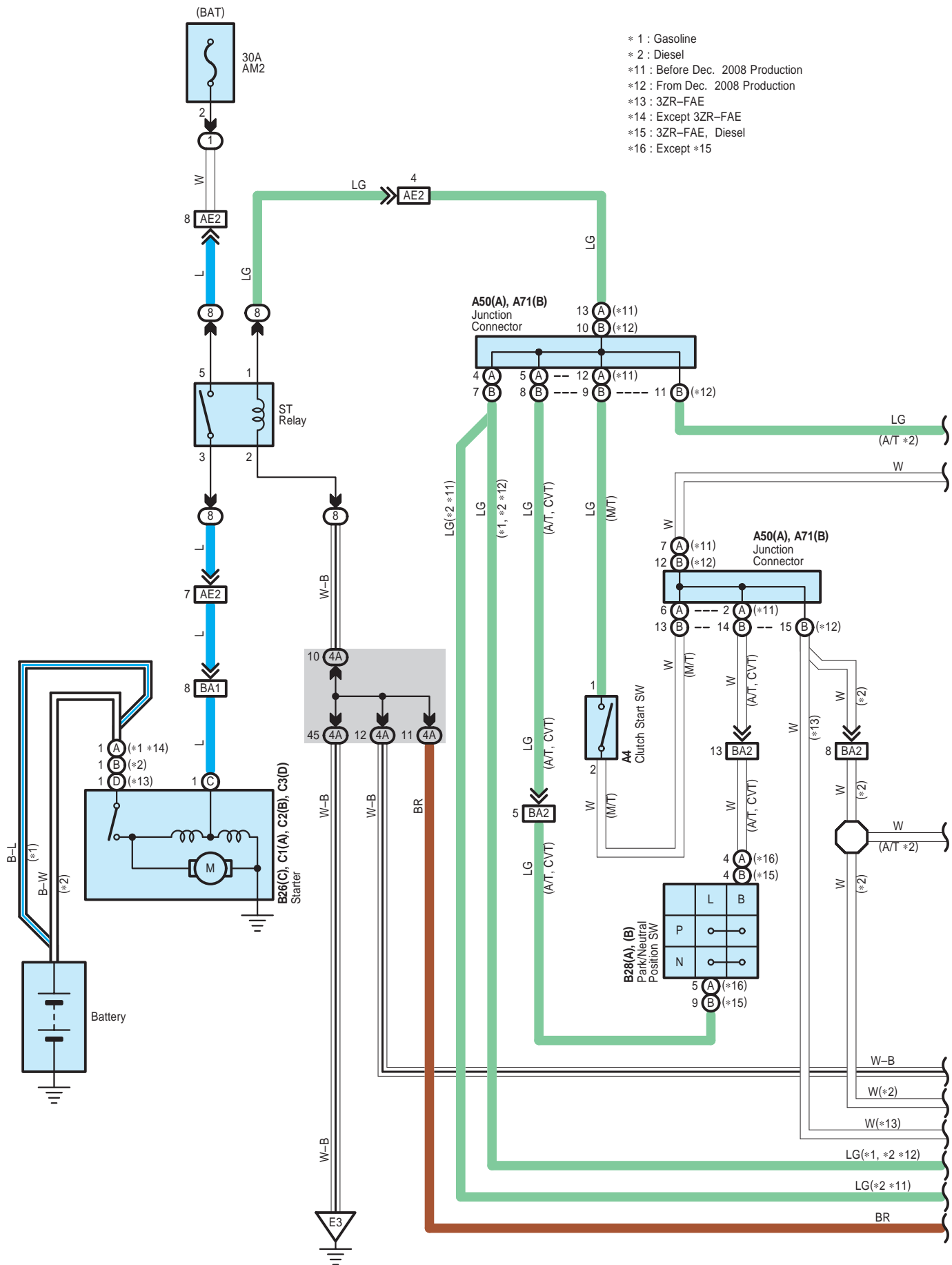

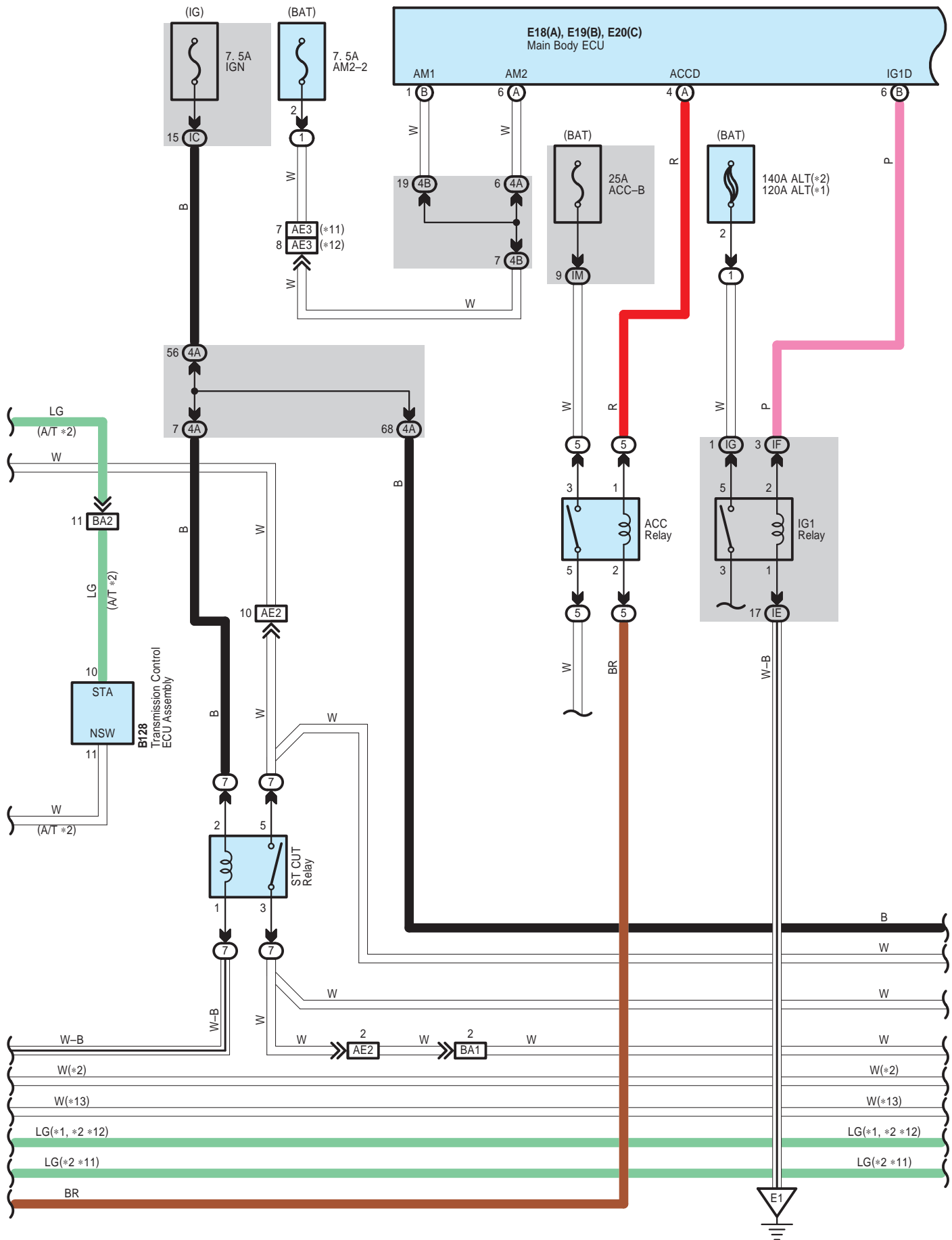

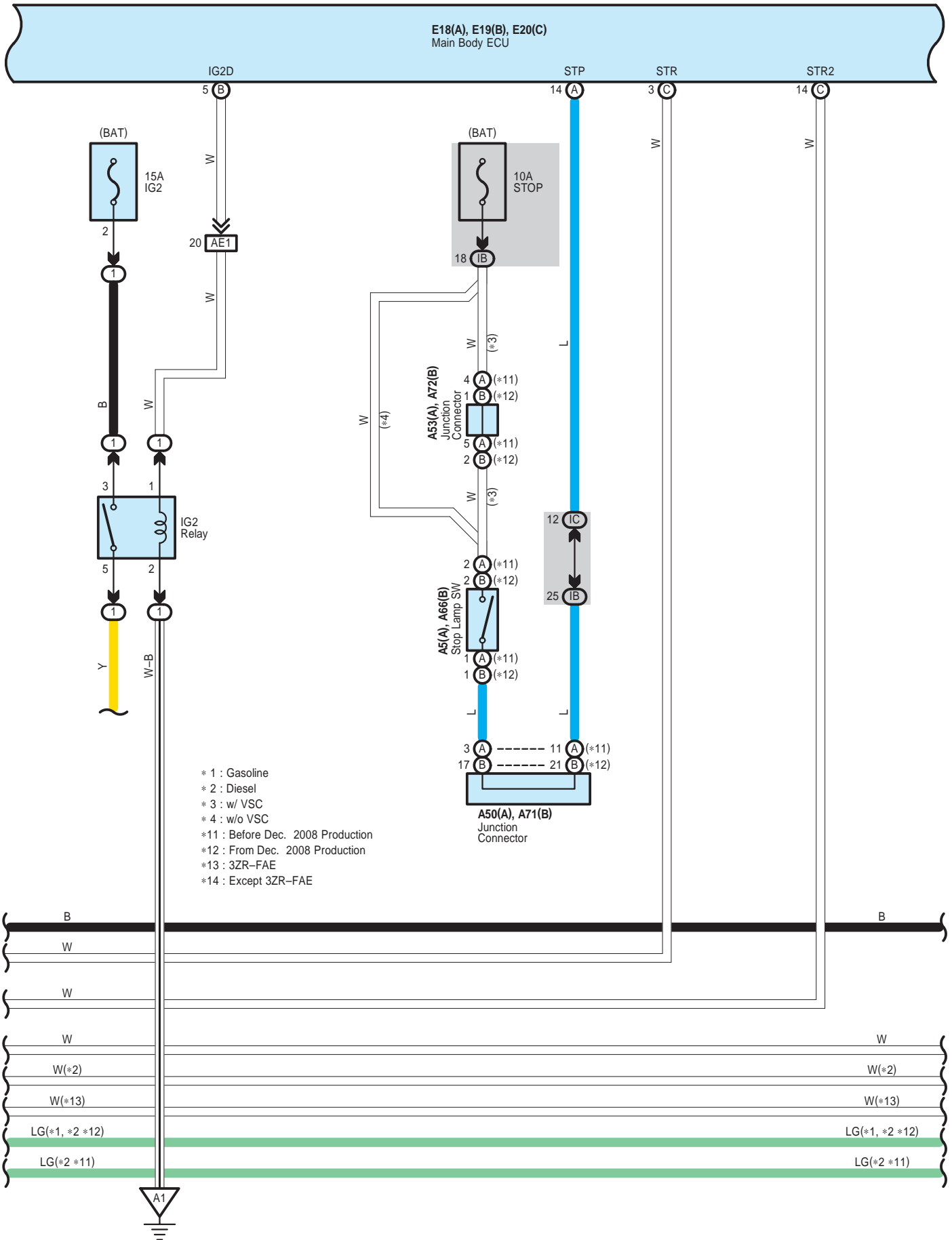

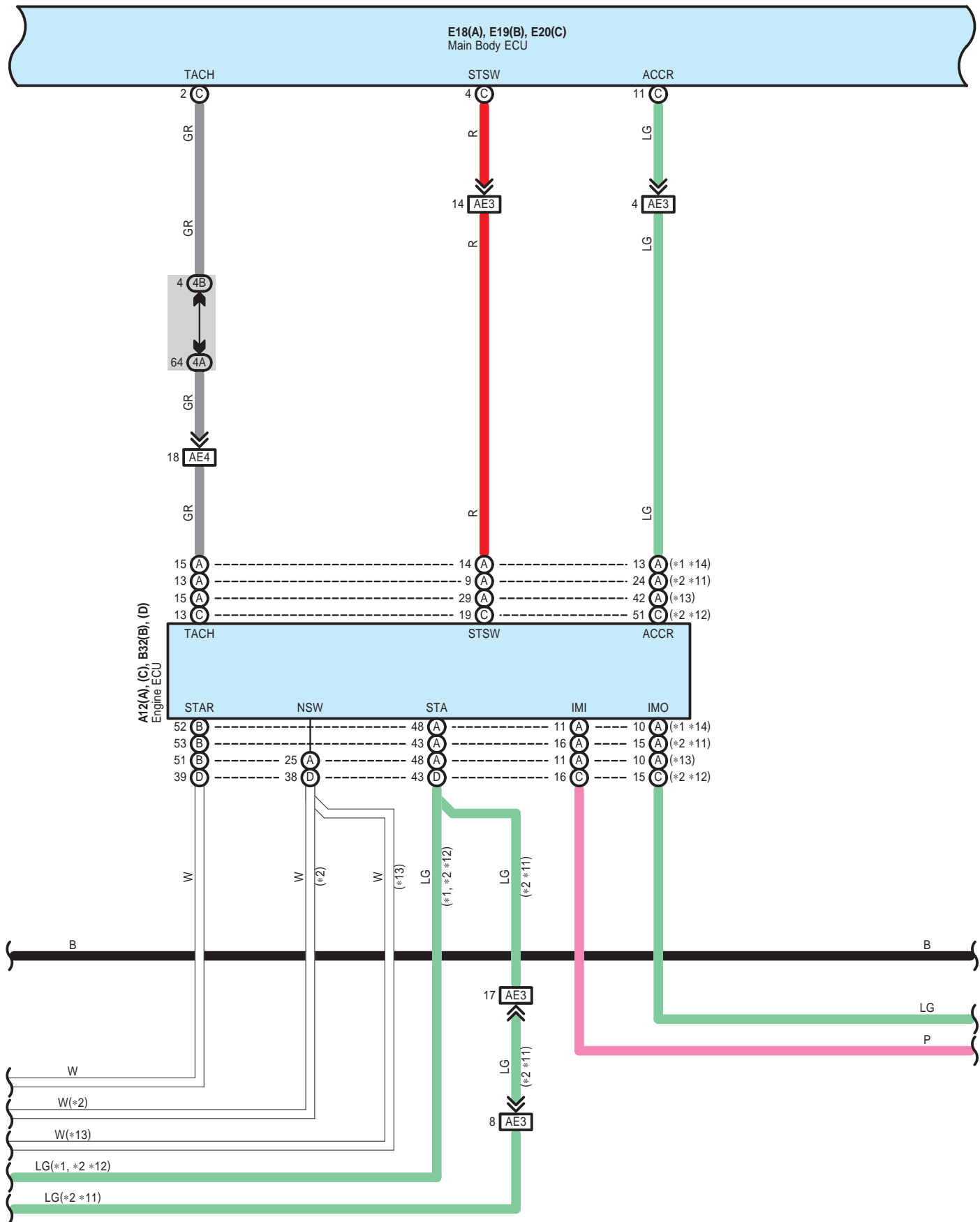

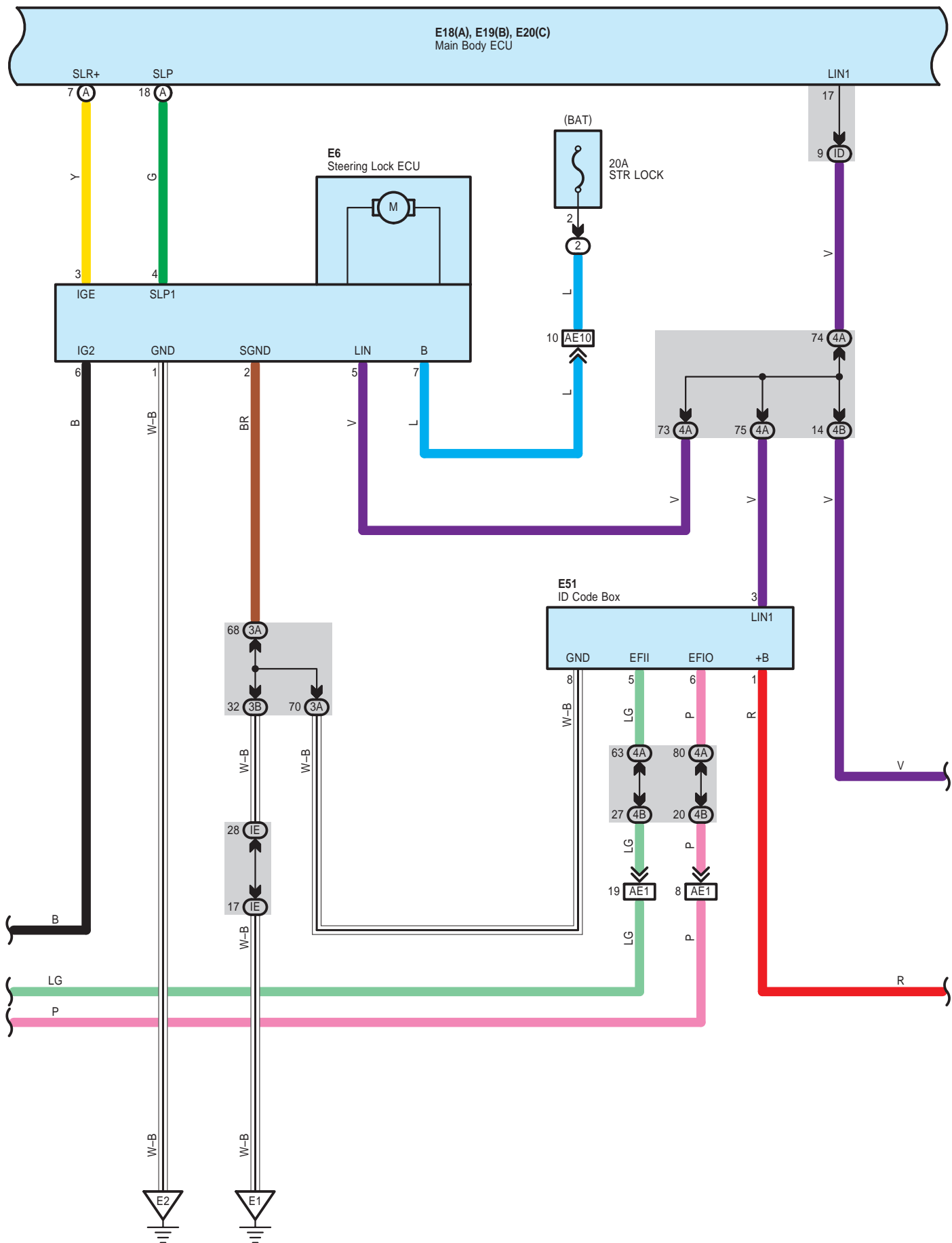

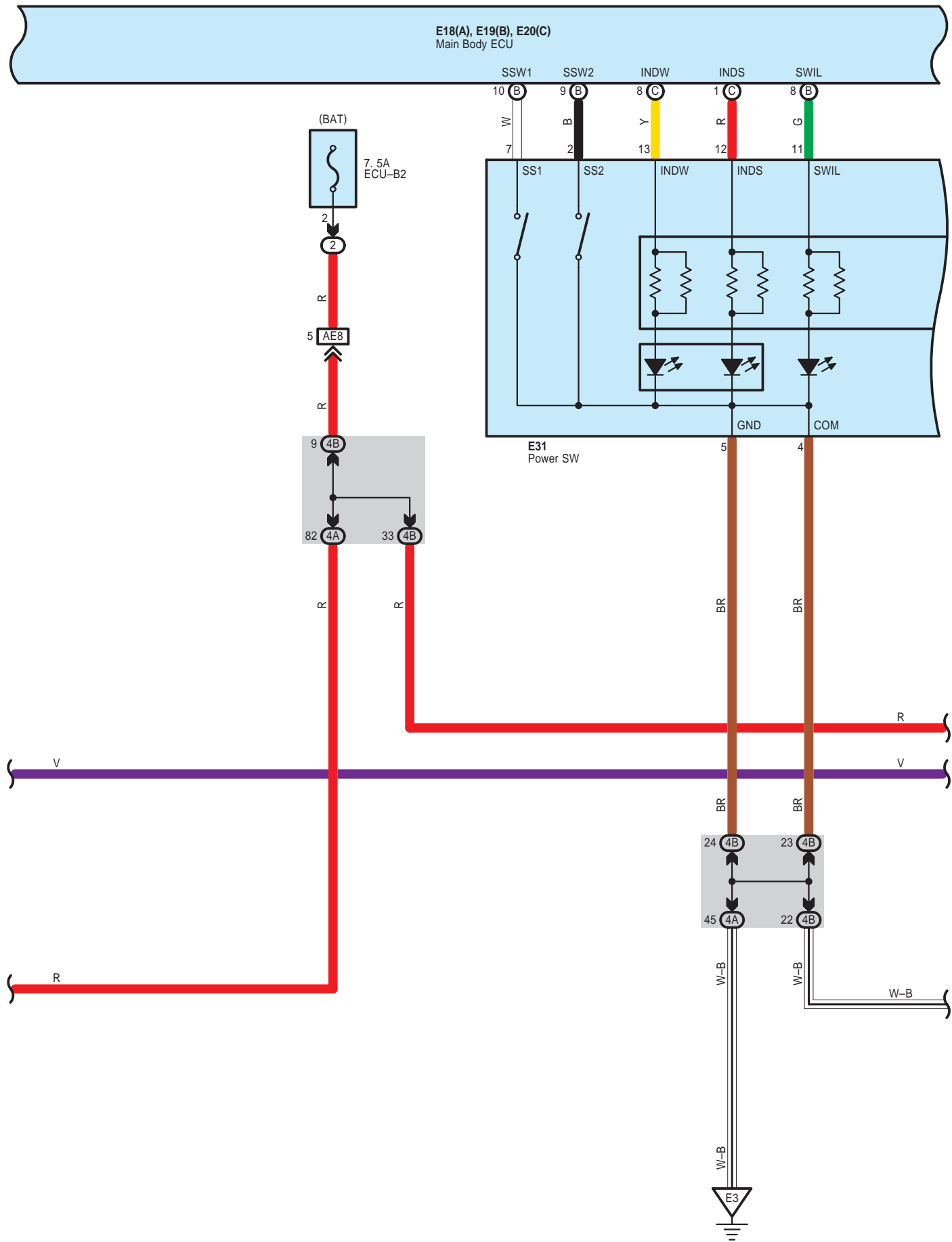

E18(A), E19(B), E20(C)
Main Body ECU

- * 9 : Before Aug. 2007 Production
- * 10 : From Aug. 2007 Production
- * 11 : Before Dec. 2008 Production
- * 12 : From Dec. 2008 Production
- * 21 : Before Aug. 2010 Production
- * 22 : From Aug. 2010 Production

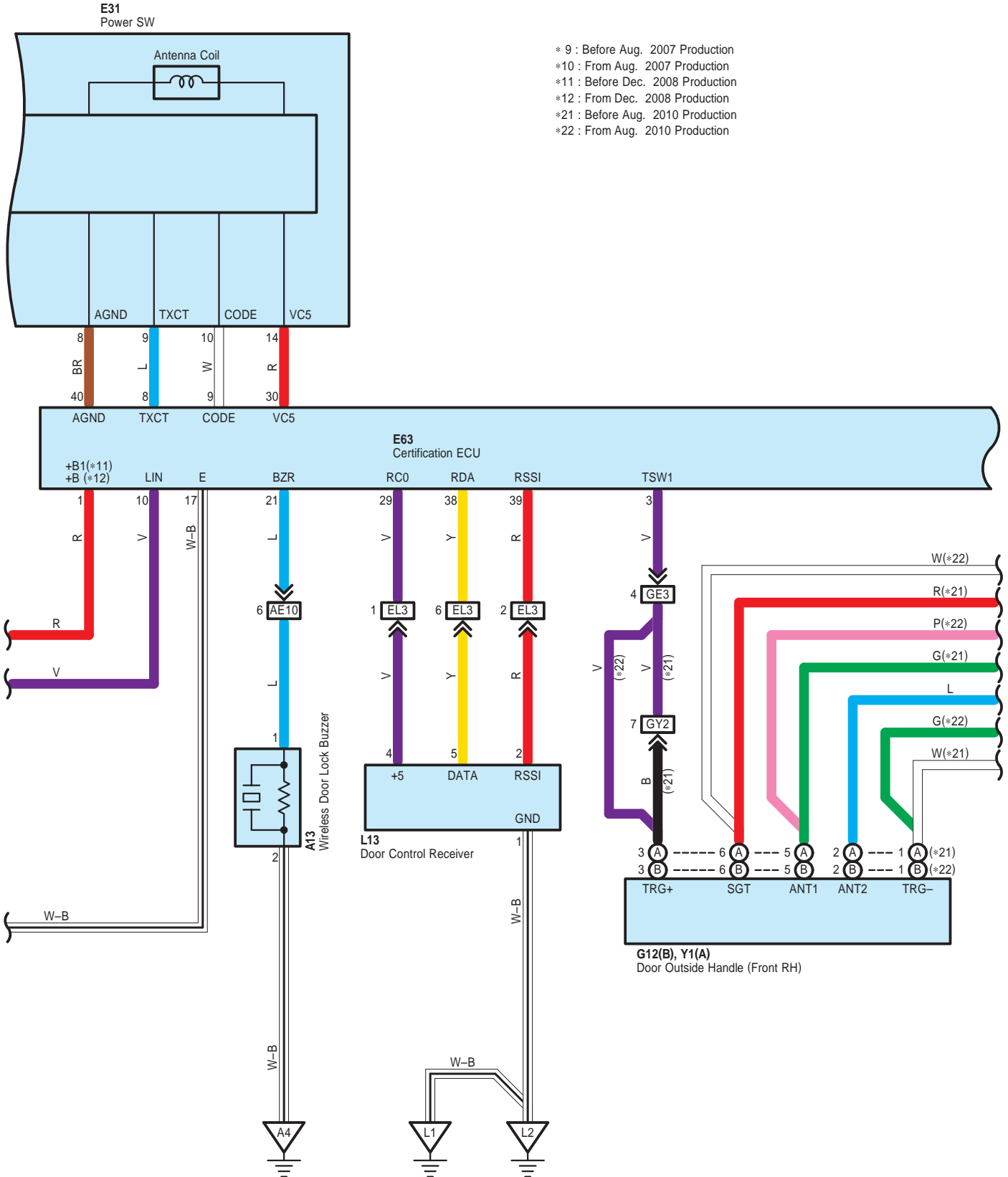

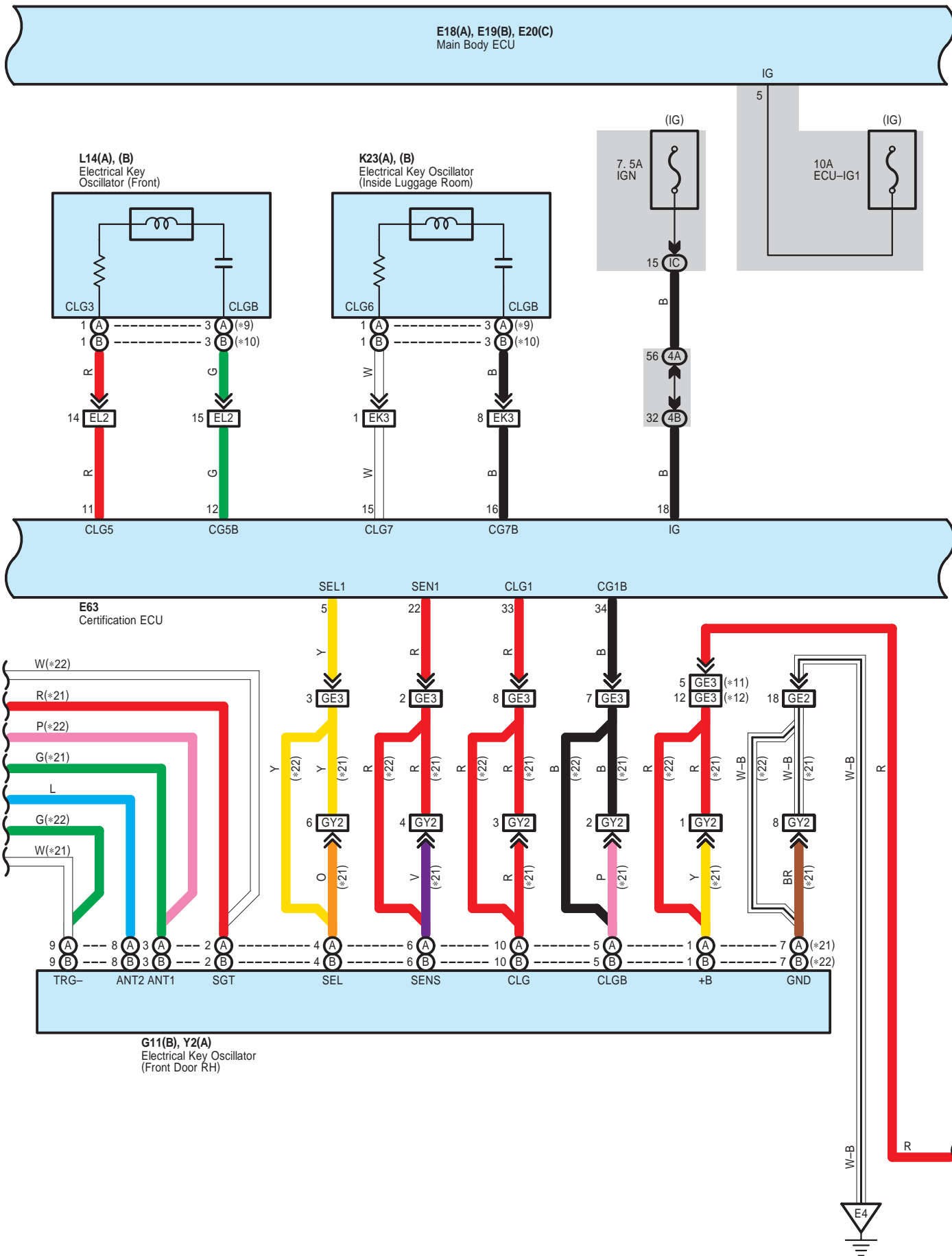

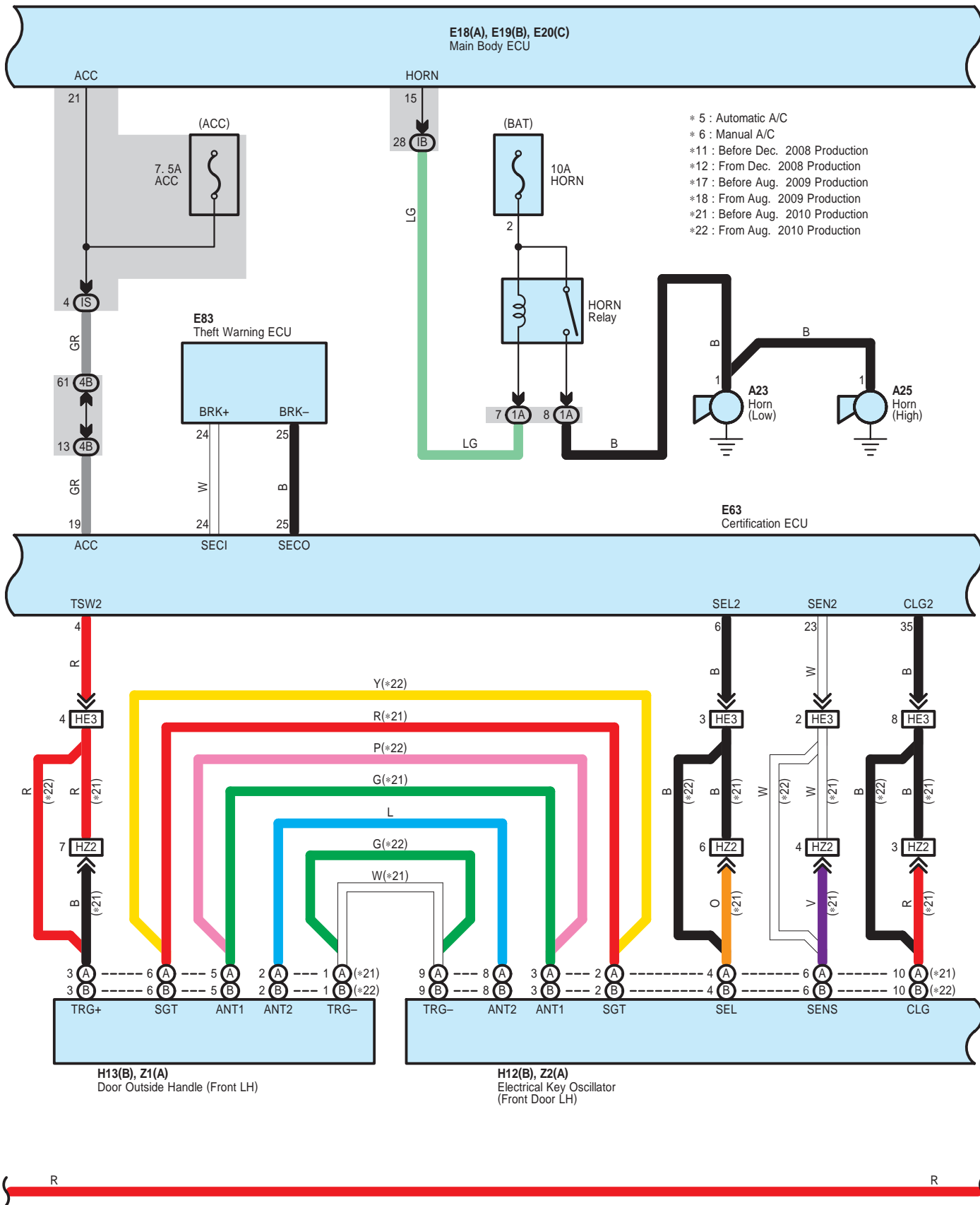

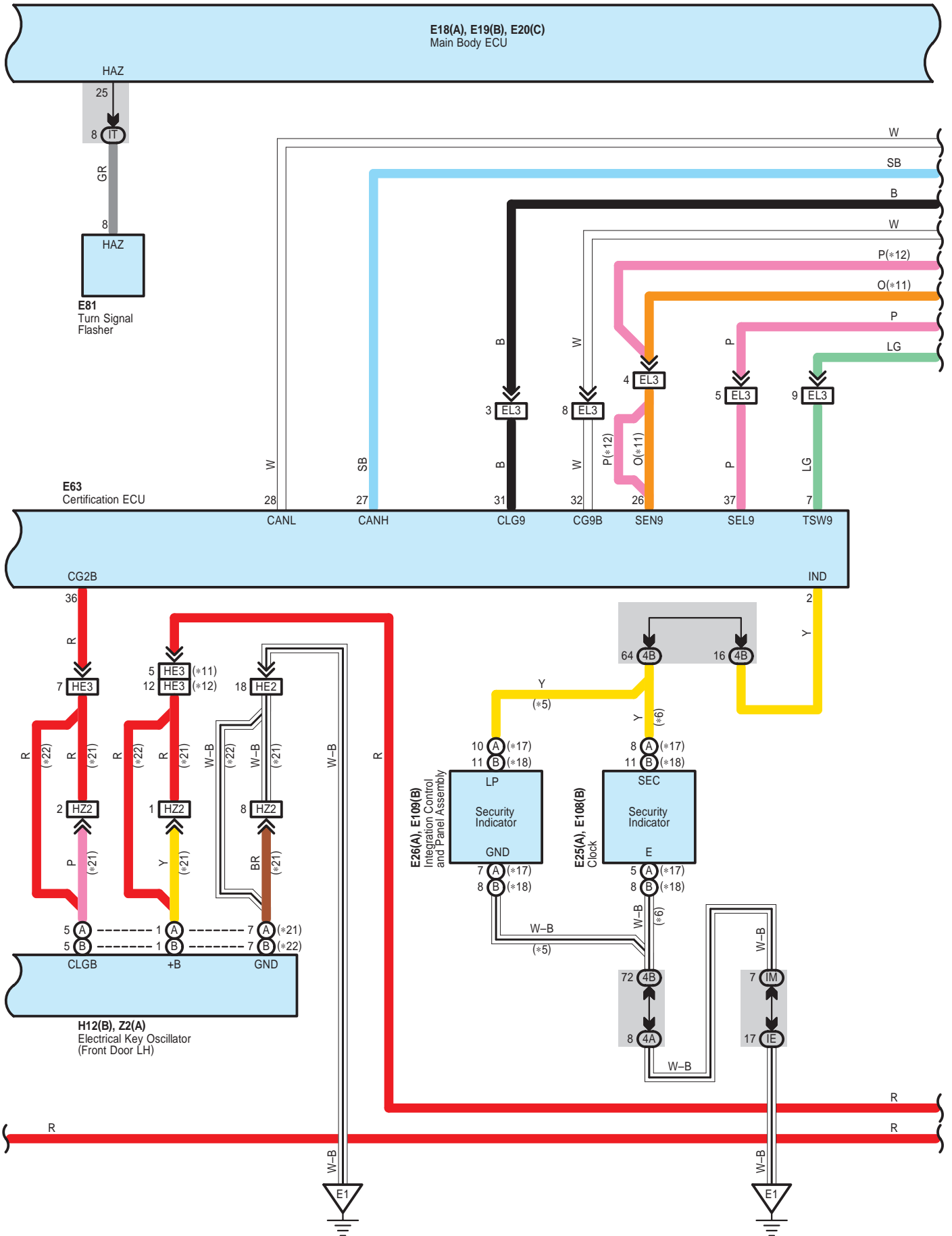

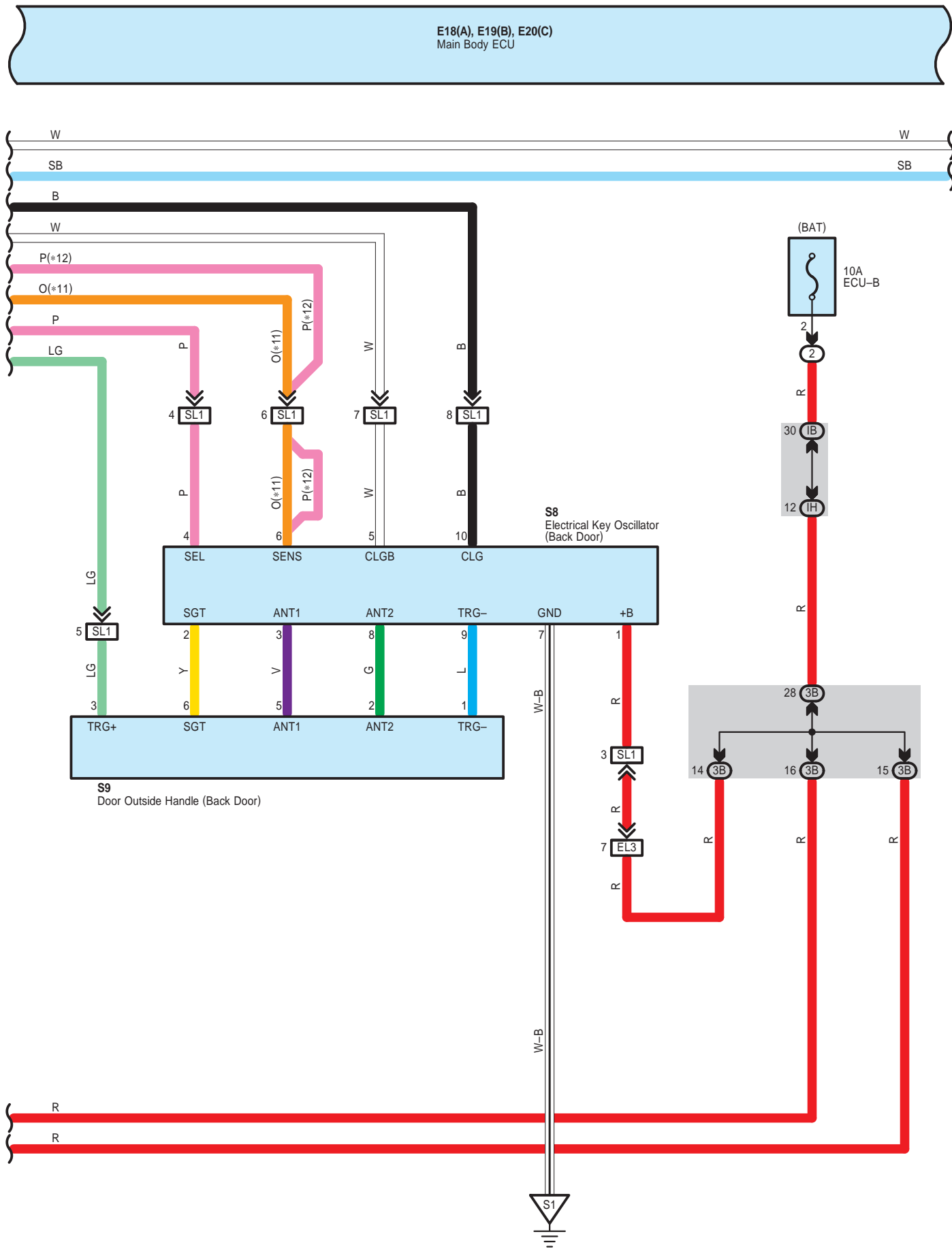

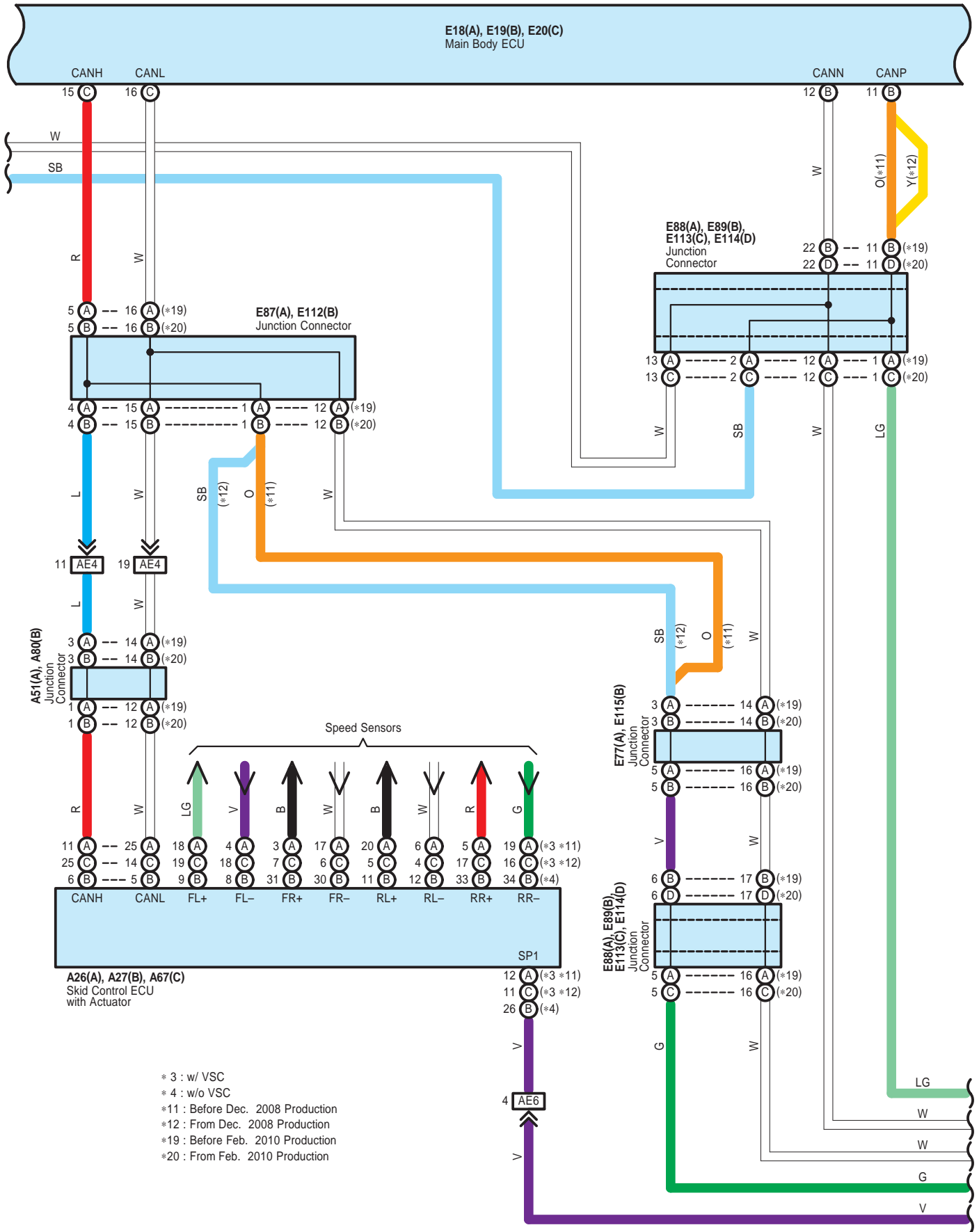

* 3 : w/ VSC
 * 4 : w/o VSC
 *11 : Before Dec. 2008 Production
 *12 : From Dec. 2008 Production
 *19 : Before Feb. 2010 Production
 *20 : From Feb. 2010 Production

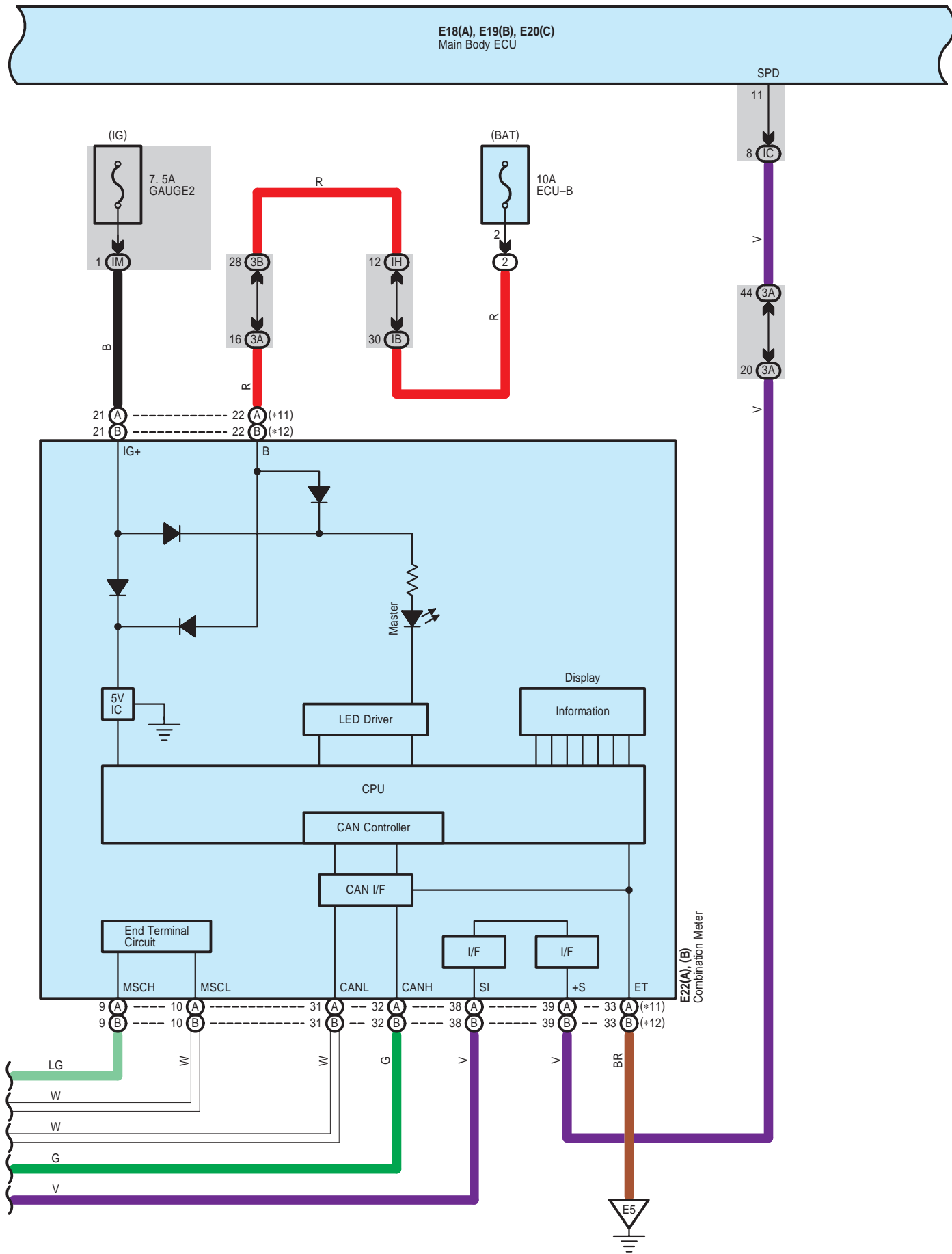

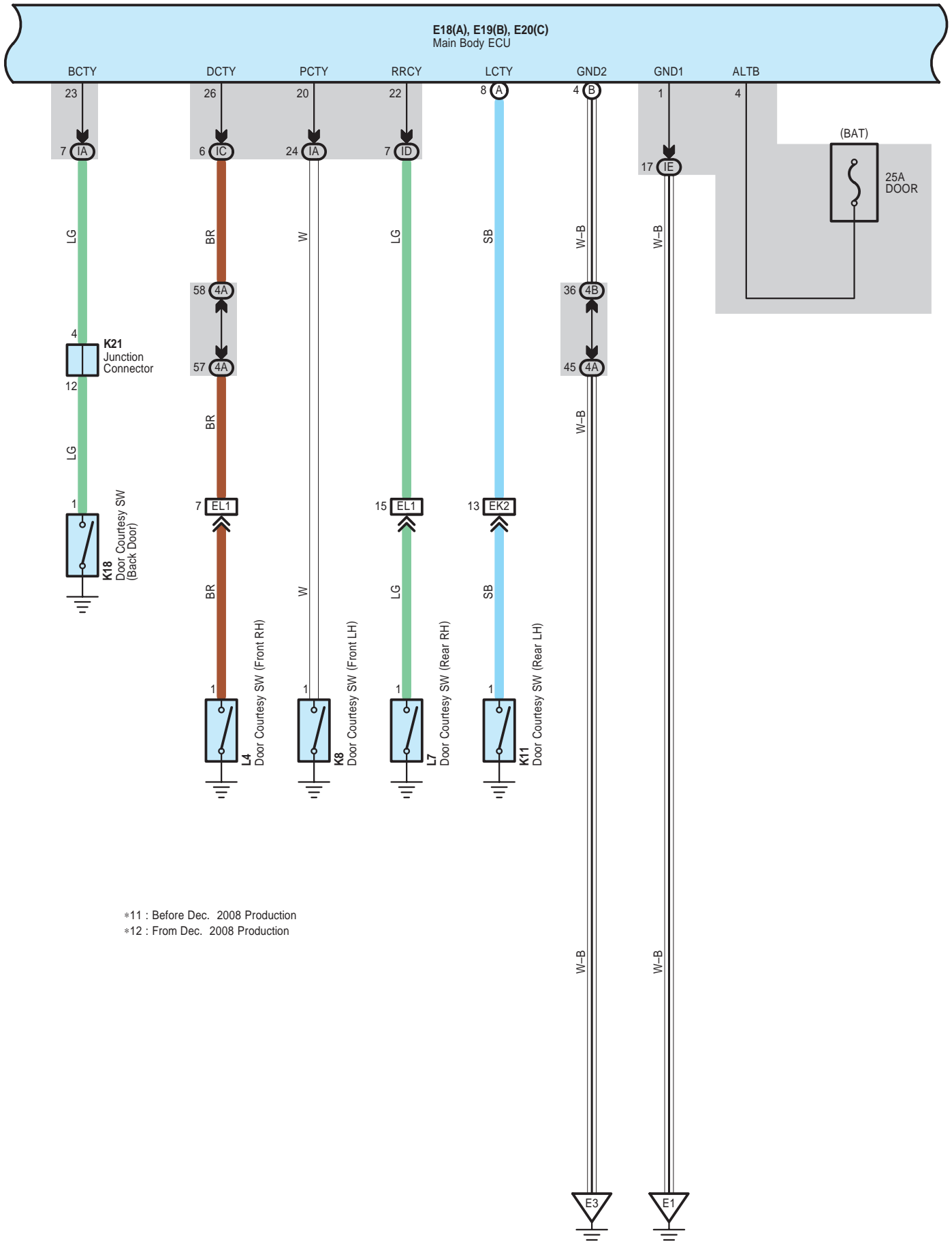

*11 : Before Dec. 2008 Production
 *12 : From Dec. 2008 Production

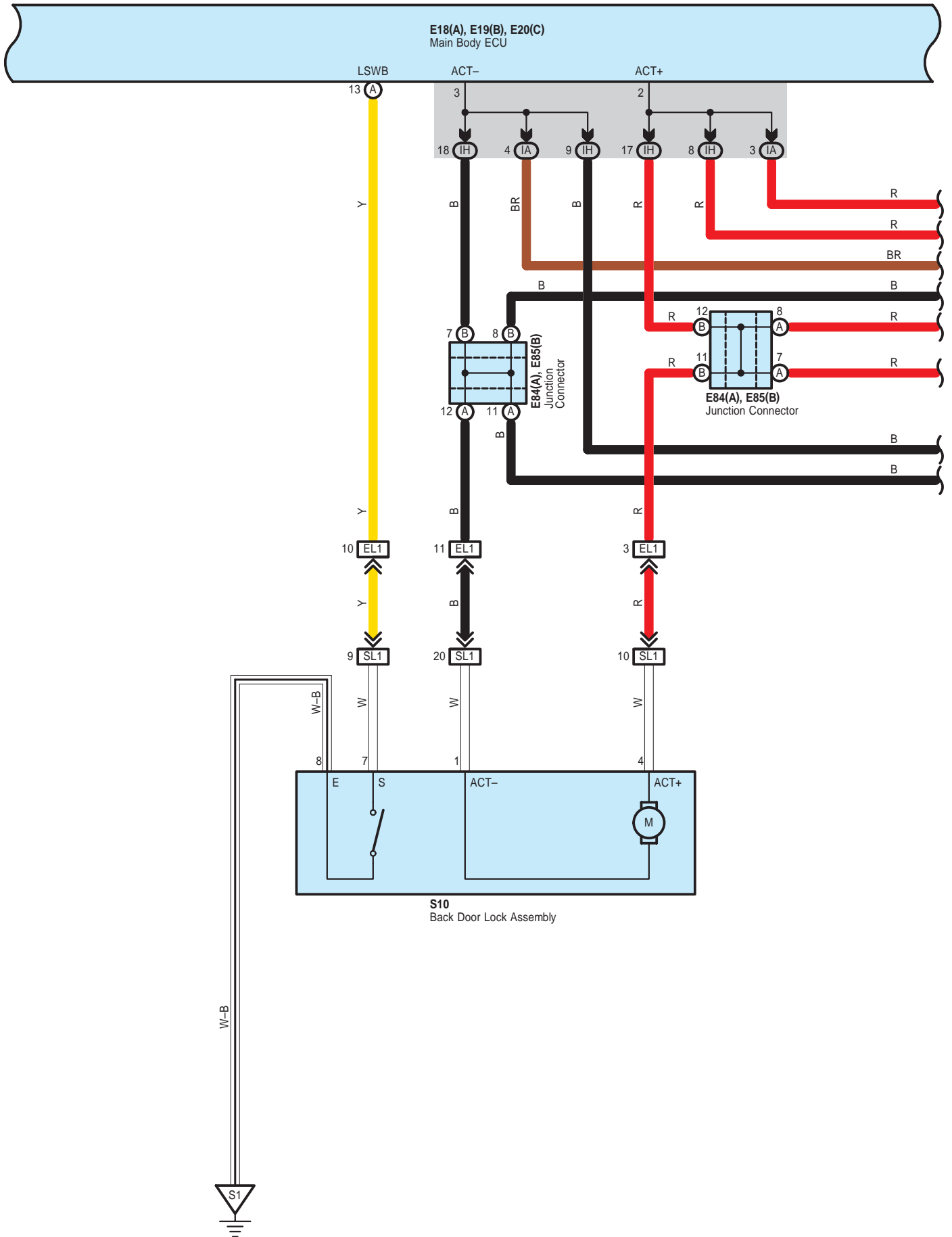

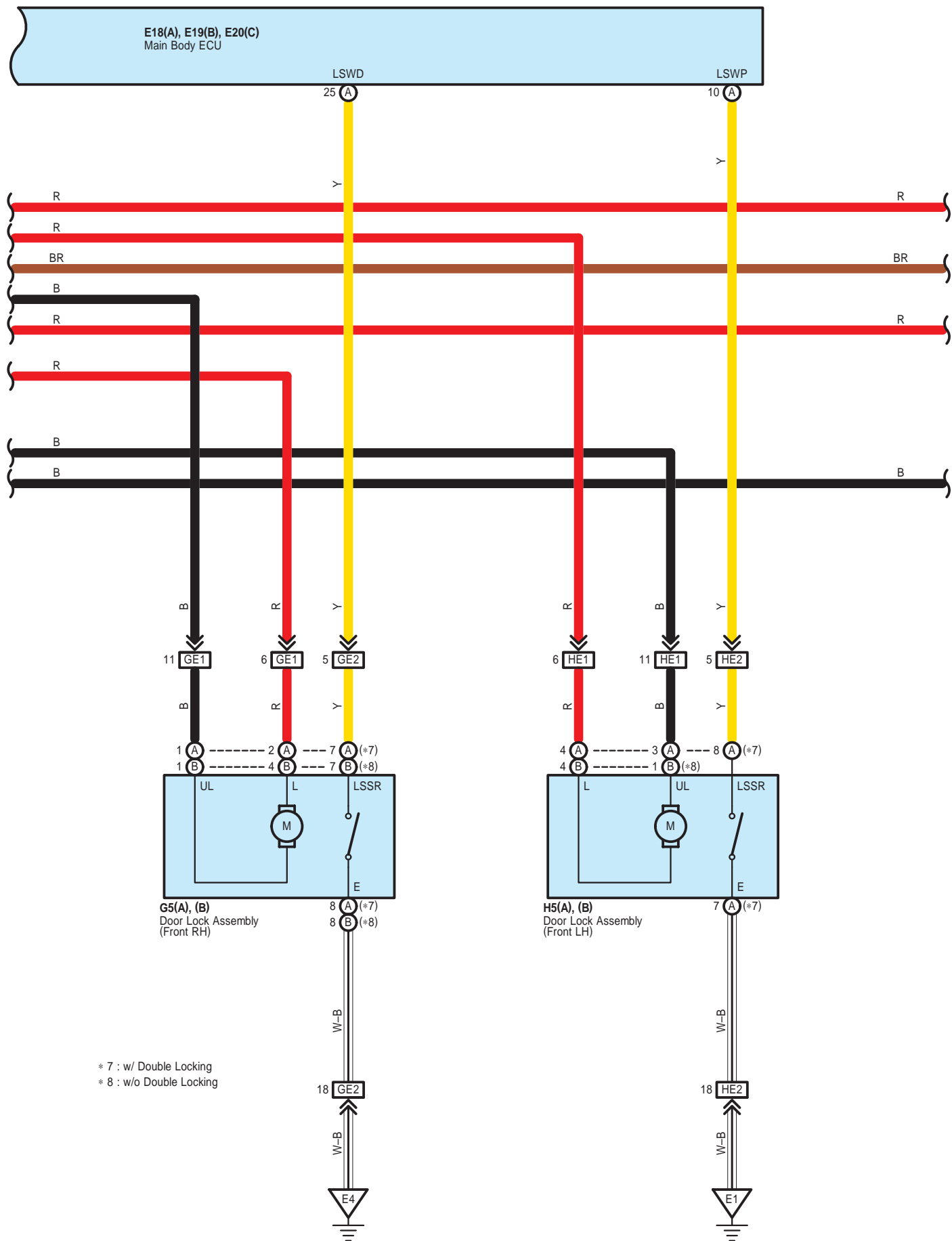

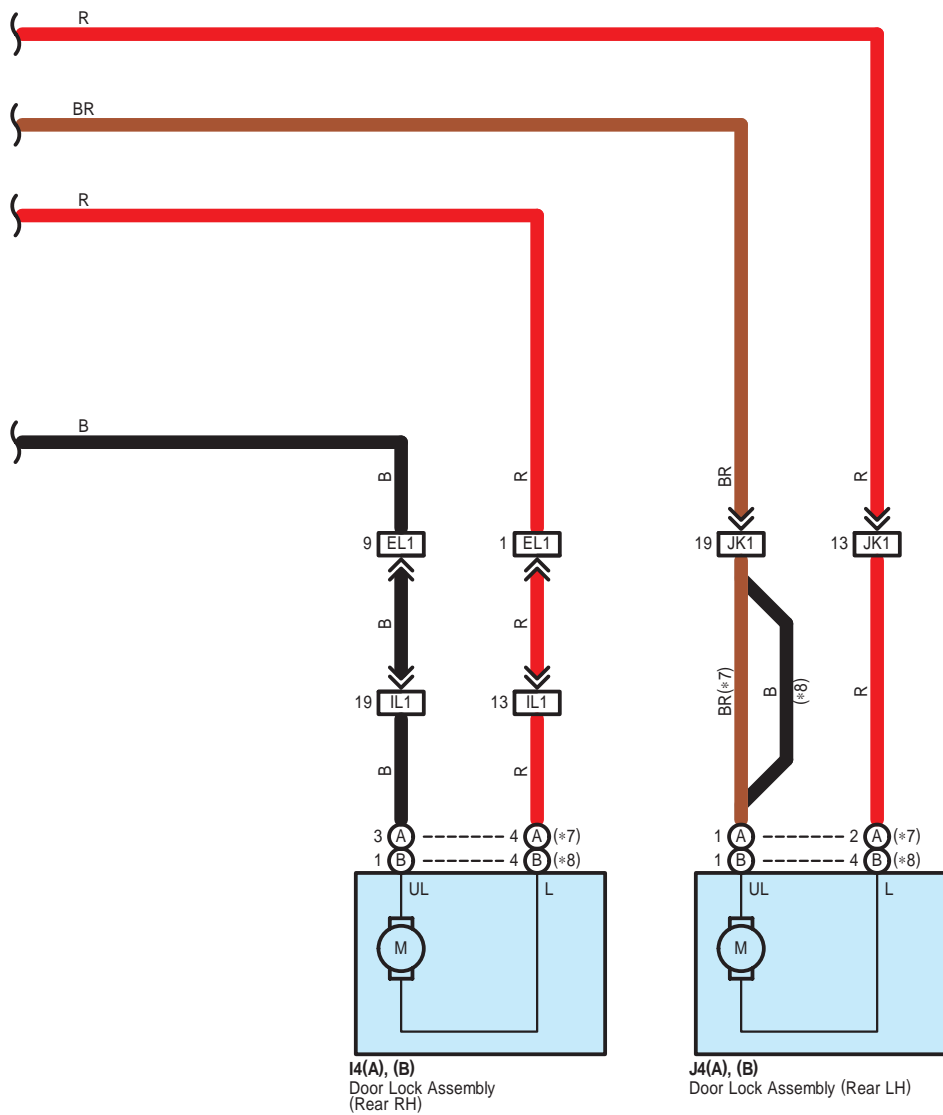

* 7 : w/ Double Locking
 * 8 : w/o Double Locking

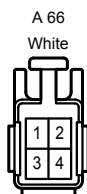
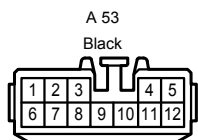
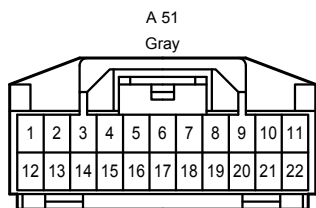
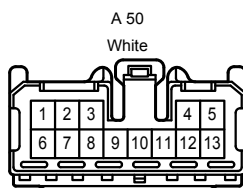
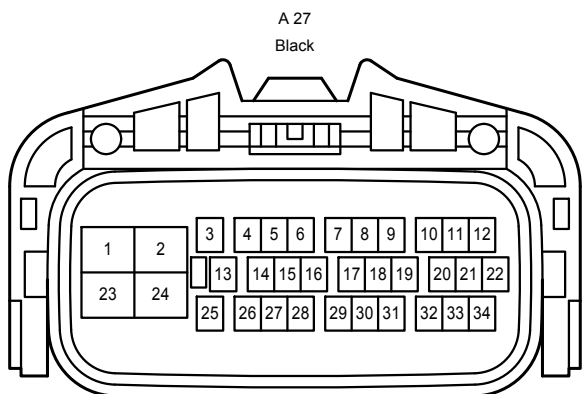
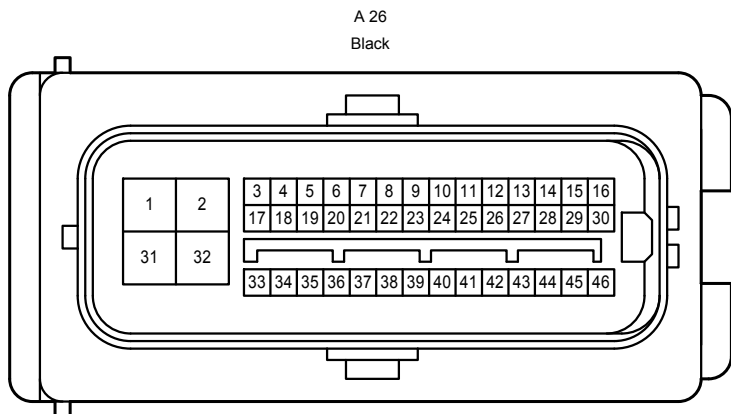
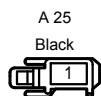
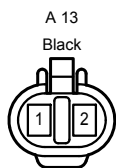
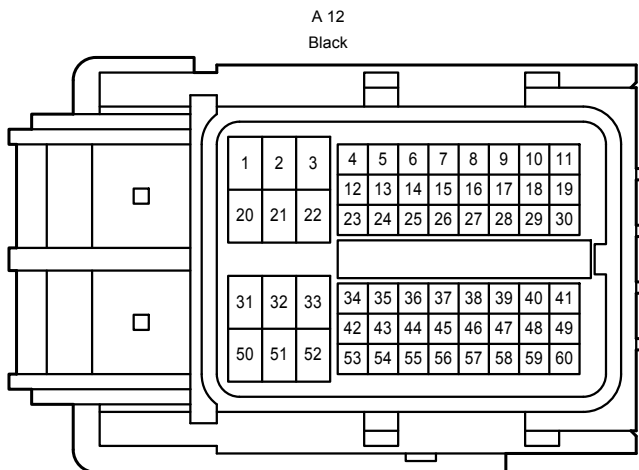
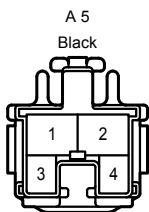
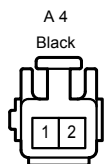

A 67
Black

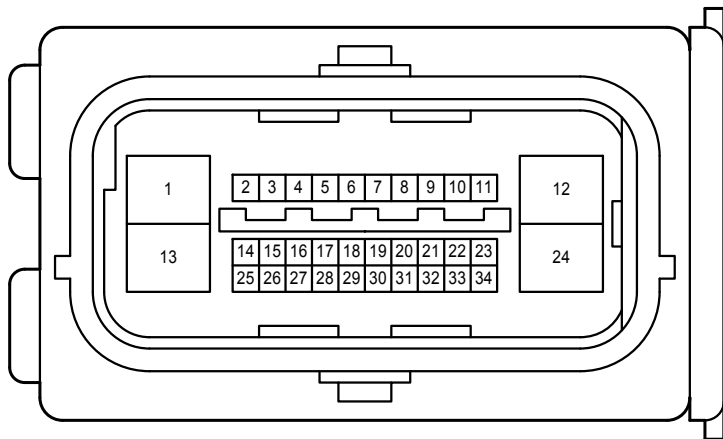

A 71
White

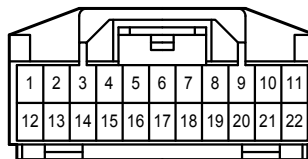

A 72
Gray

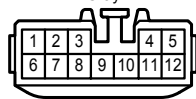

A 80
Gray

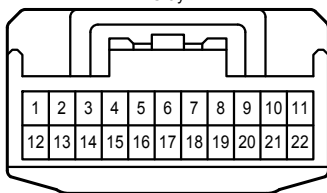

B 26
Black



B 28
Gray

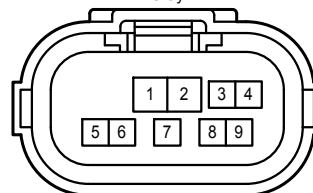

B 32
Black

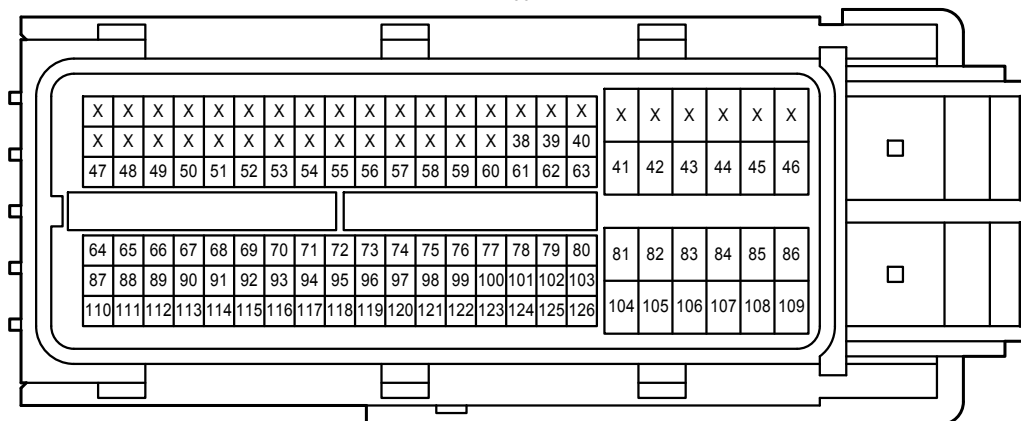

B128
Gray

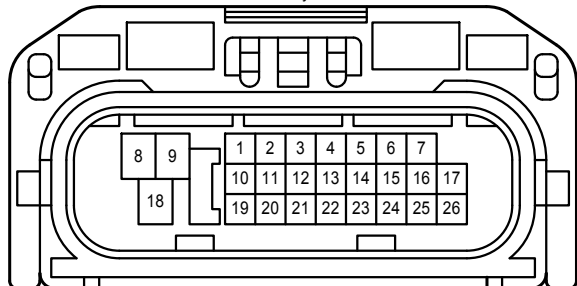

C 1

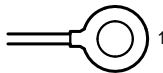

C 2

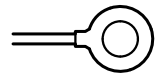

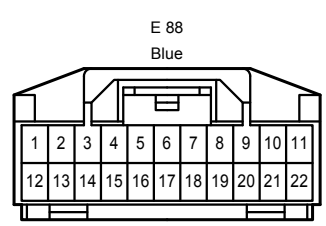
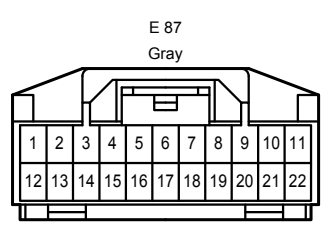
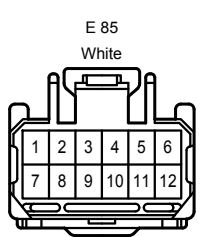
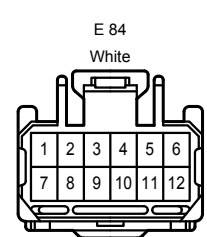
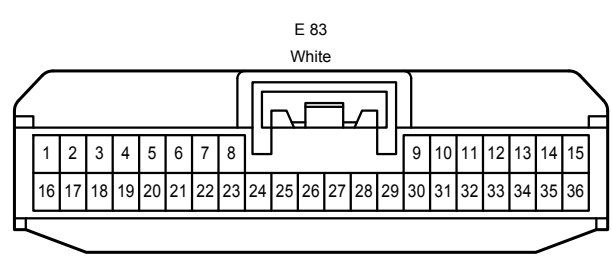
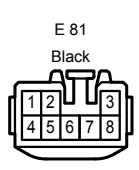
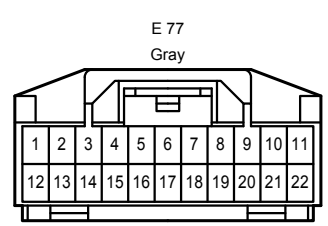
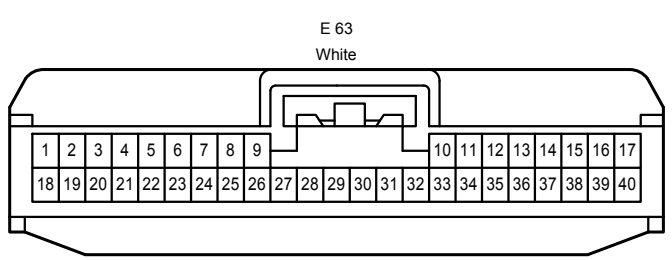
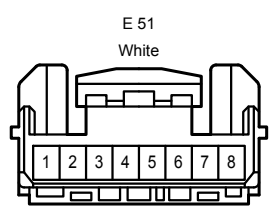
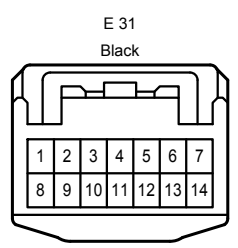
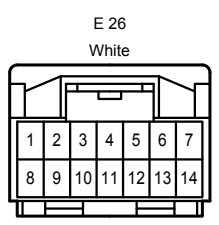
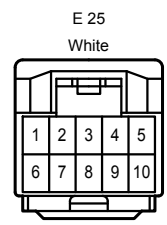
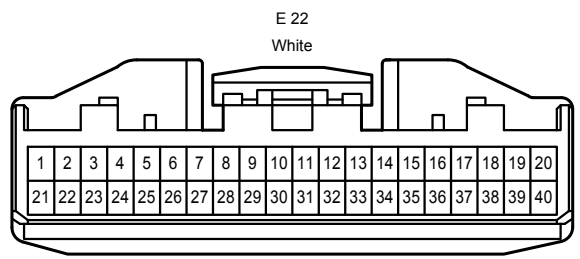
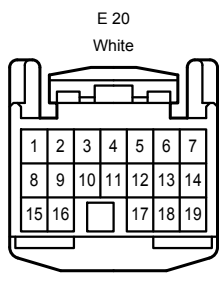
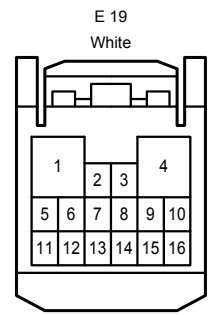
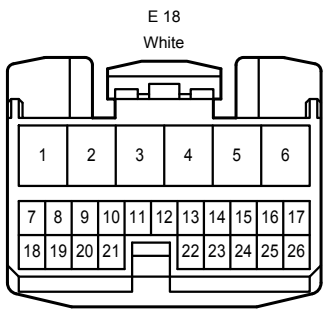
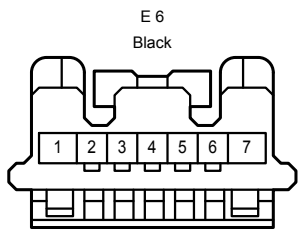
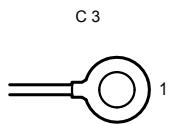

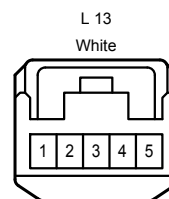
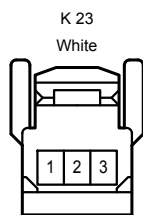
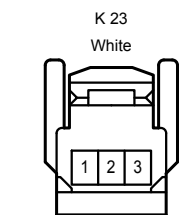
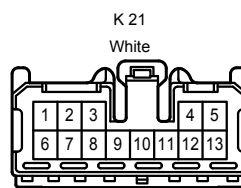
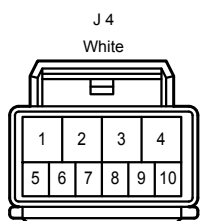
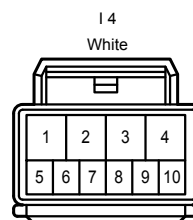
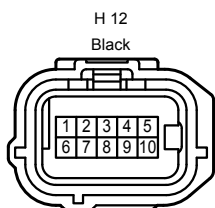
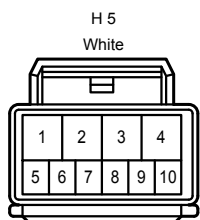
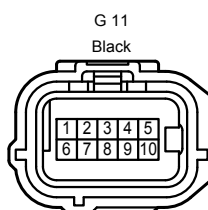
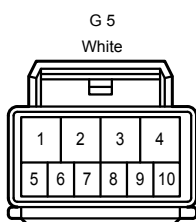
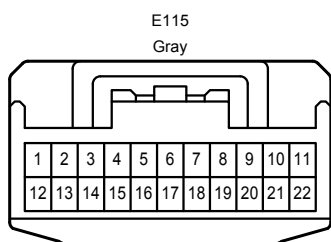
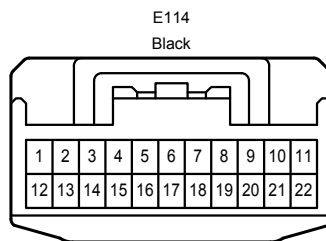
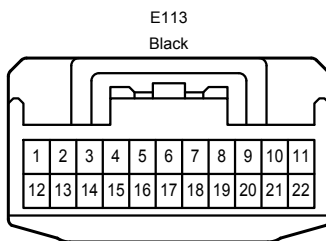
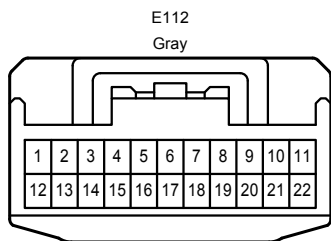
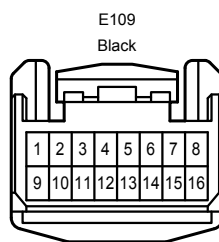
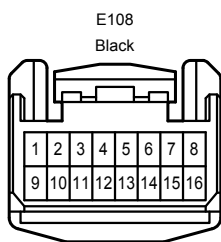
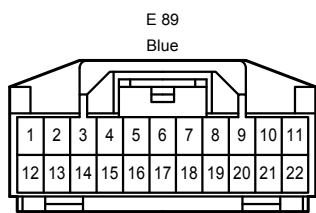

(From Aug. 2007 Production)

(Before Aug. 2007 Production)

L 14

Black

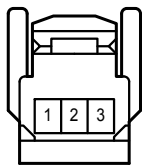

(From Aug. 2007 Production)

L 14

White

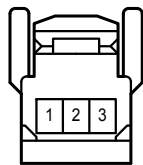

(Before Aug. 2007 Production)

S 8

Black



S 9

White

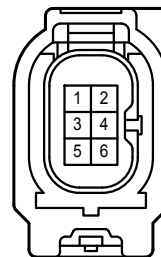

S 10

White

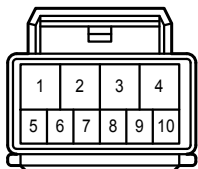

Y 1

White

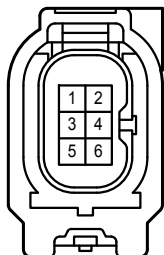

Y 2

Black



Z 1

White

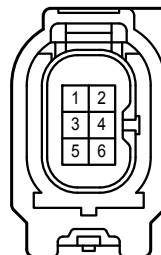

Z 2

Black



1A

White

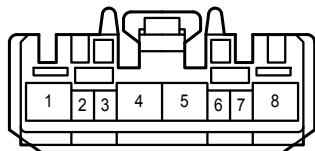

3A

White

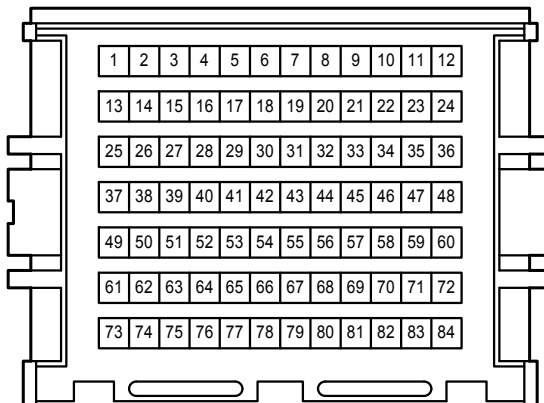

3B

White

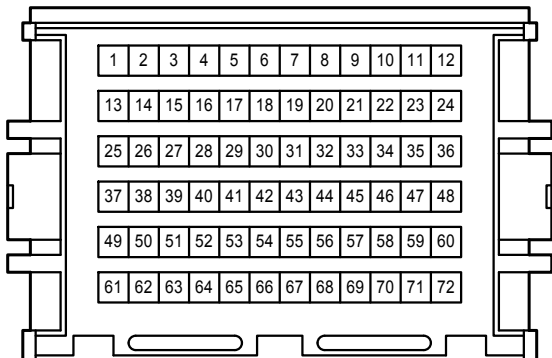

4A

White

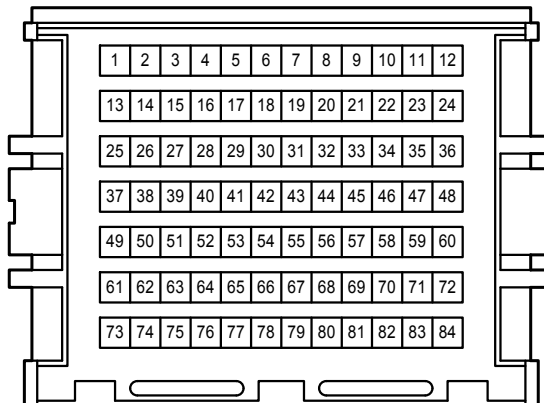

4B
White

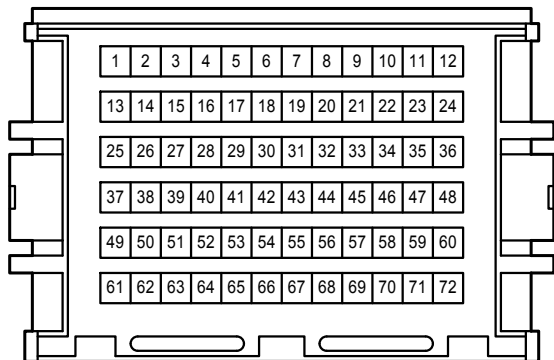

IA
White

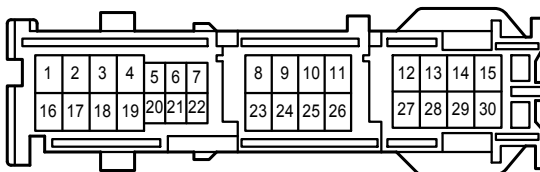

IB
White

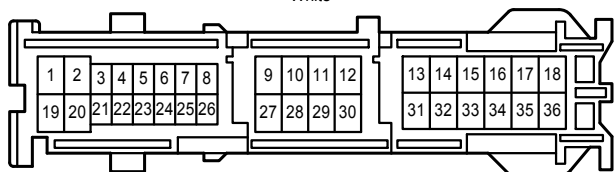

IC
White

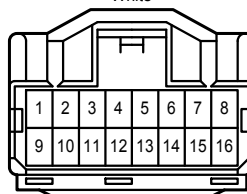

ID
White

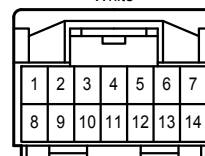

IE
White

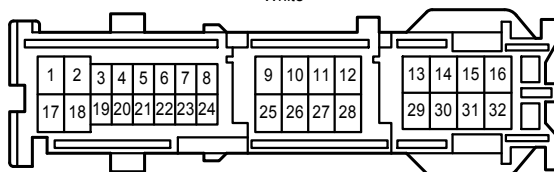

IF
White

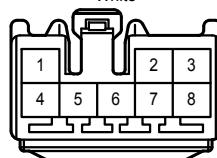

IG
White

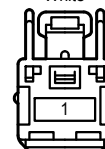

IH
White

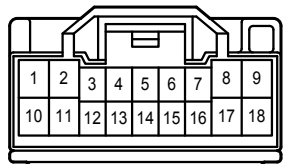

IM
White

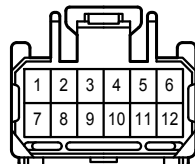

IS
White

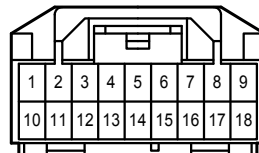

IT
White



AE1
White

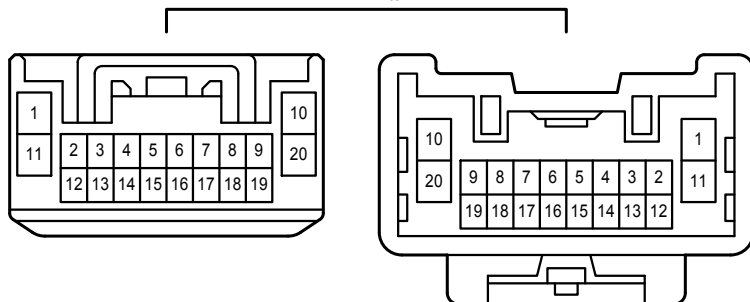

AE2
White

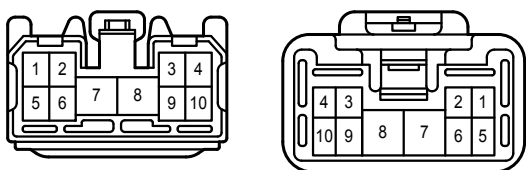

AE3
Black

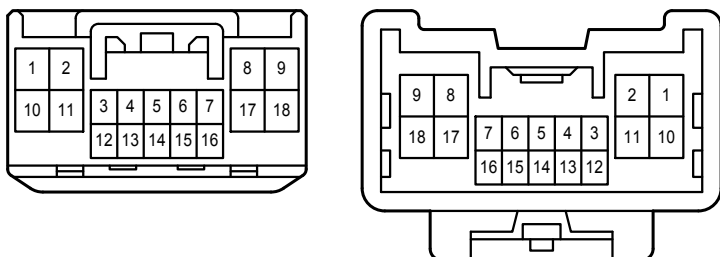

AE4
Gray

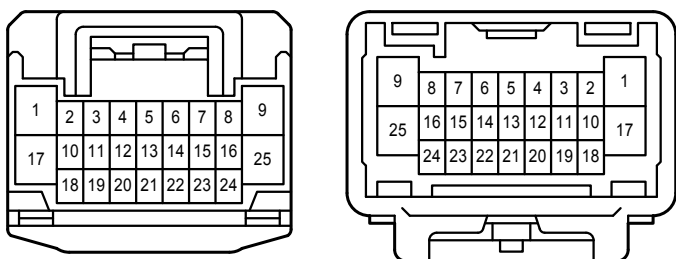

AE6
White

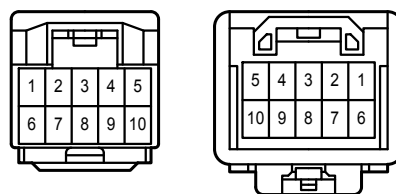

AE8
White

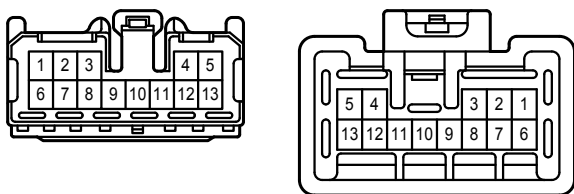

AE10
White

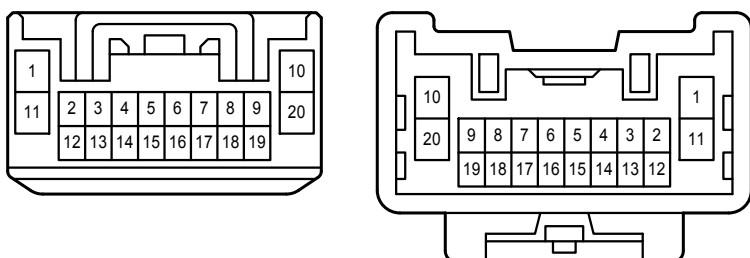

BA1
White

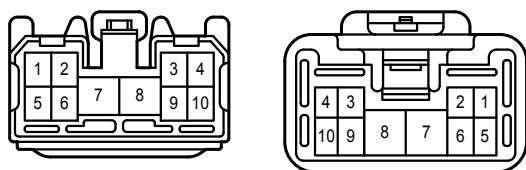

BA2
Gray

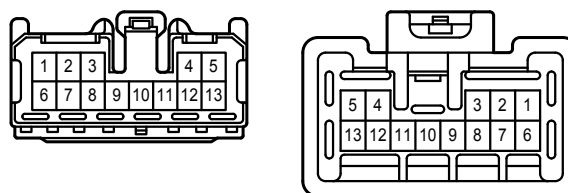

EK2
White

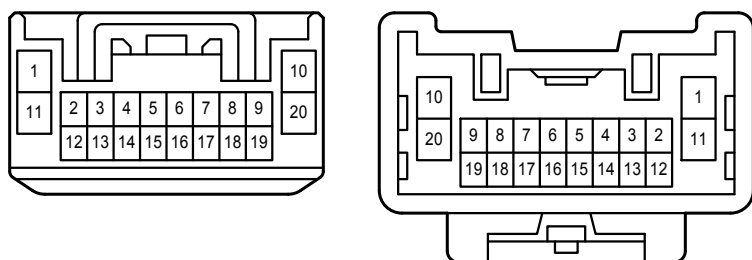

EK3
White

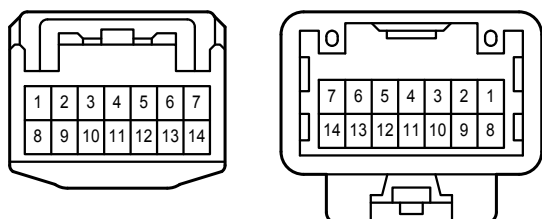

EL1
White

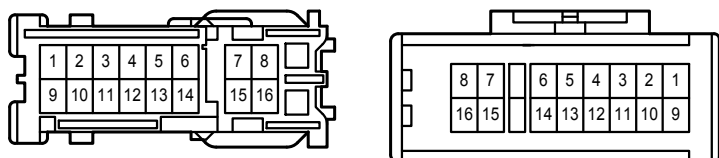

EL2
White

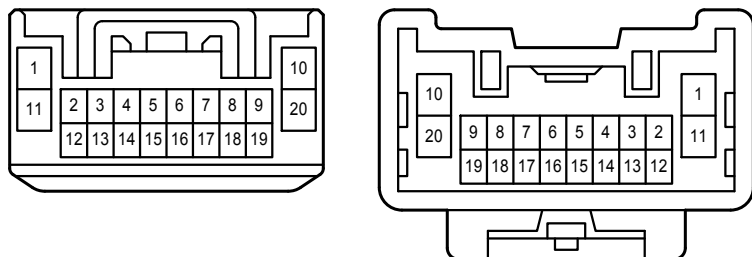

EL3
White

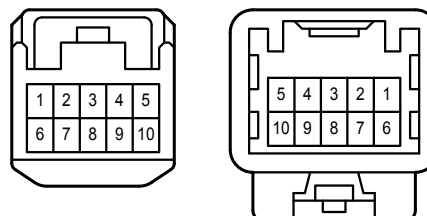

GE1
White

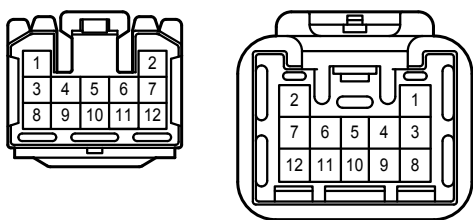

GE2
White

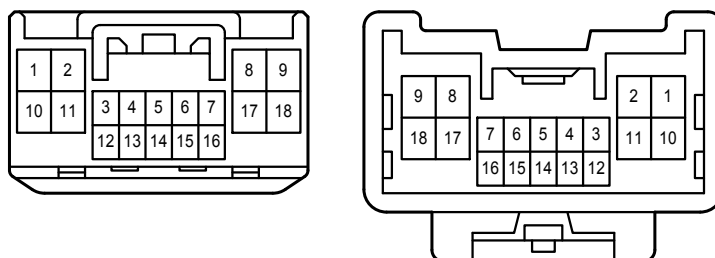

GE3
White

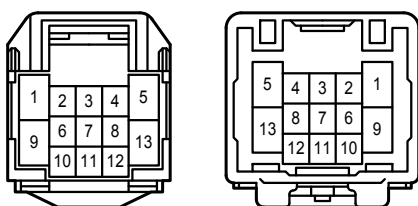

GY2
Gray

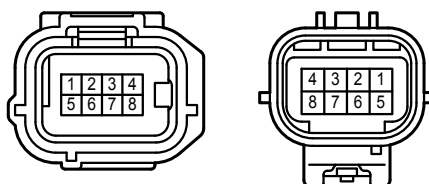

HE1
White

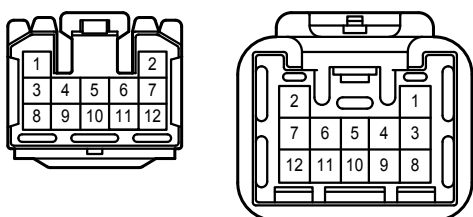

HE2
White

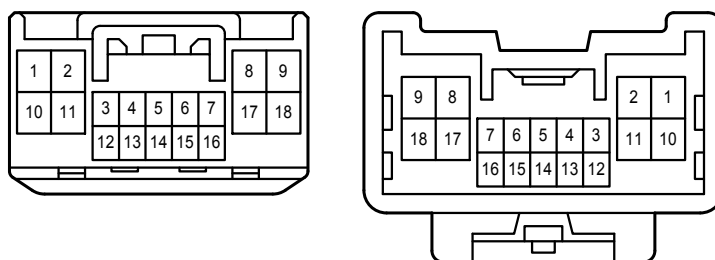

HE3
White

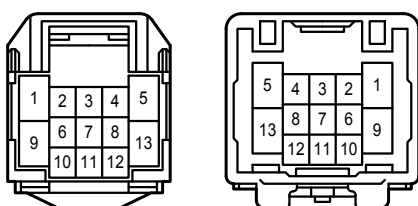

HZ2
Gray

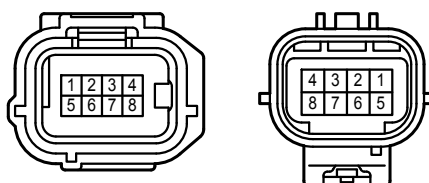

IL1
White

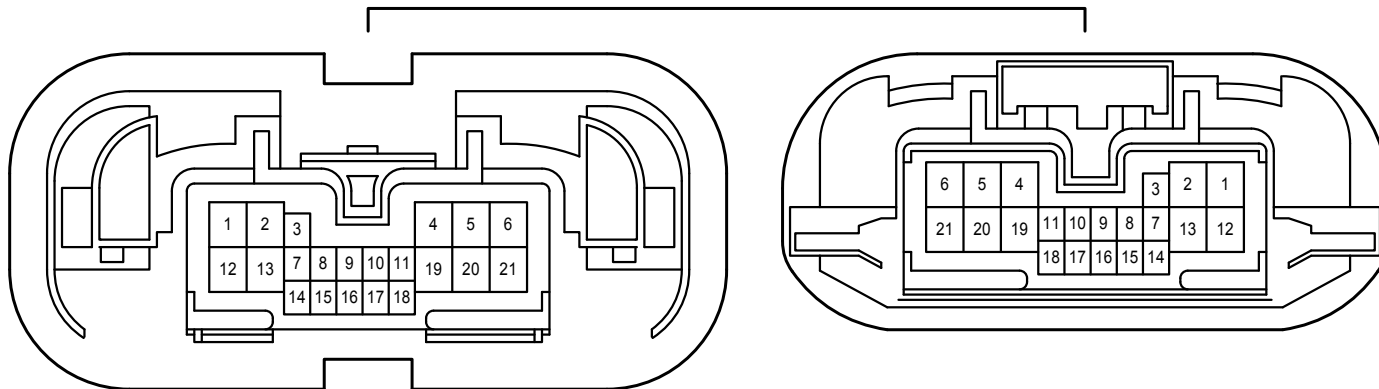

JK1
White

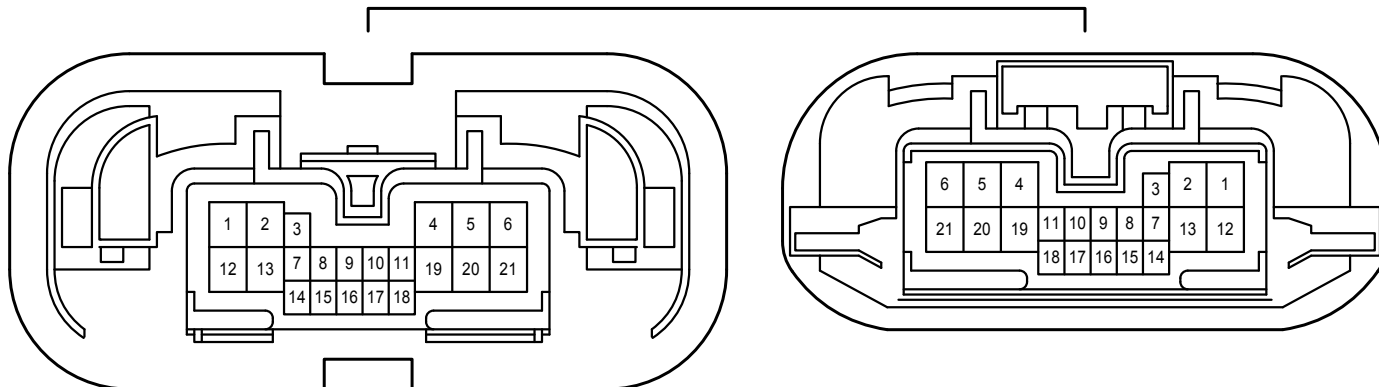

SL1
White

