

ECT and A/T Indicator <2AZ-FE, 1AZ-FE>

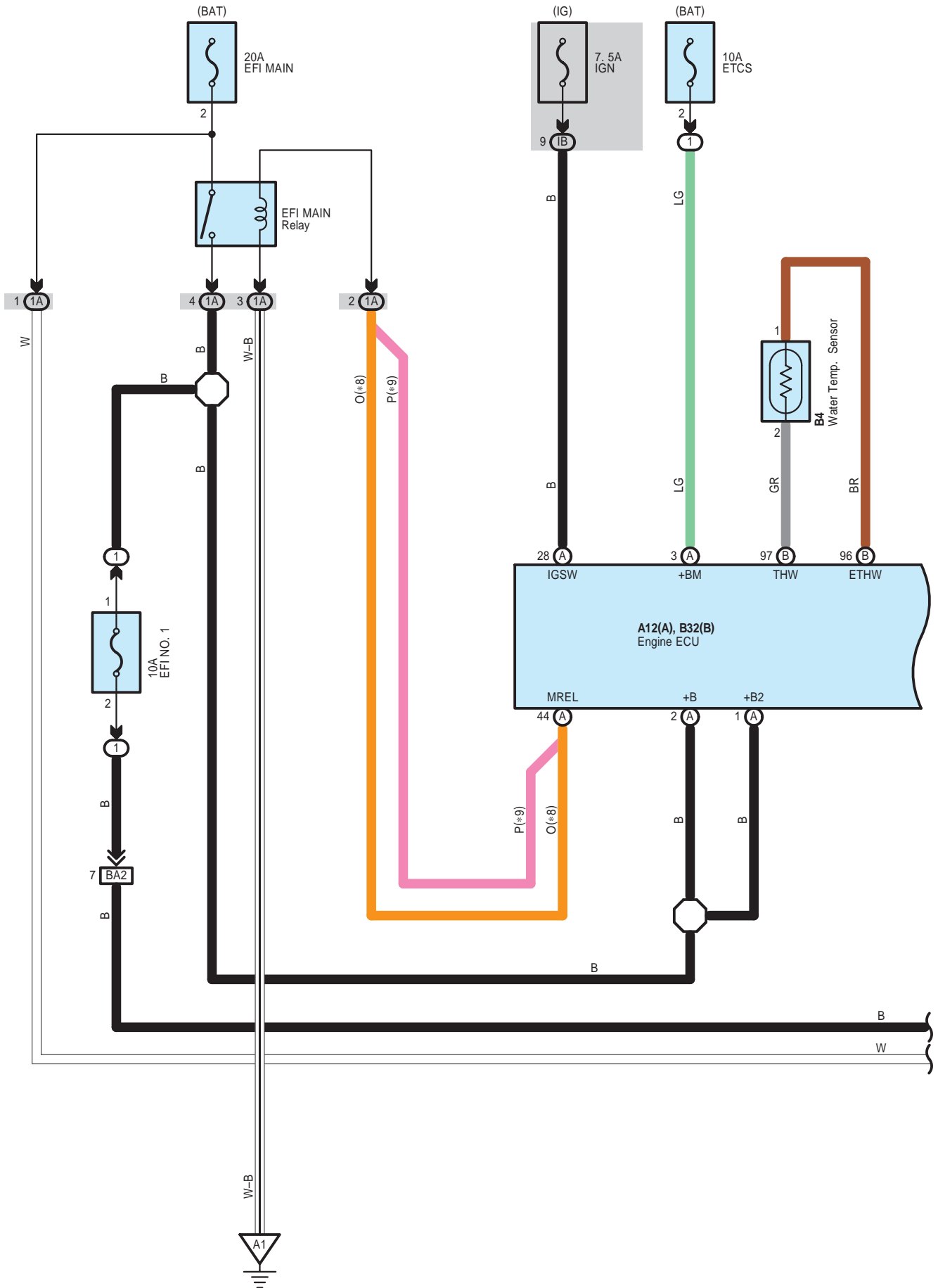

ECT and A/T Indicator <2AZ-FE, 1AZ-FE>

* 8 : Before Aug. 2008 Production Except Europe, Before Dec. 2008 Production Europe
 * 9 : From Aug. 2008 Production Except Europe, From Dec. 2008 Production Europe

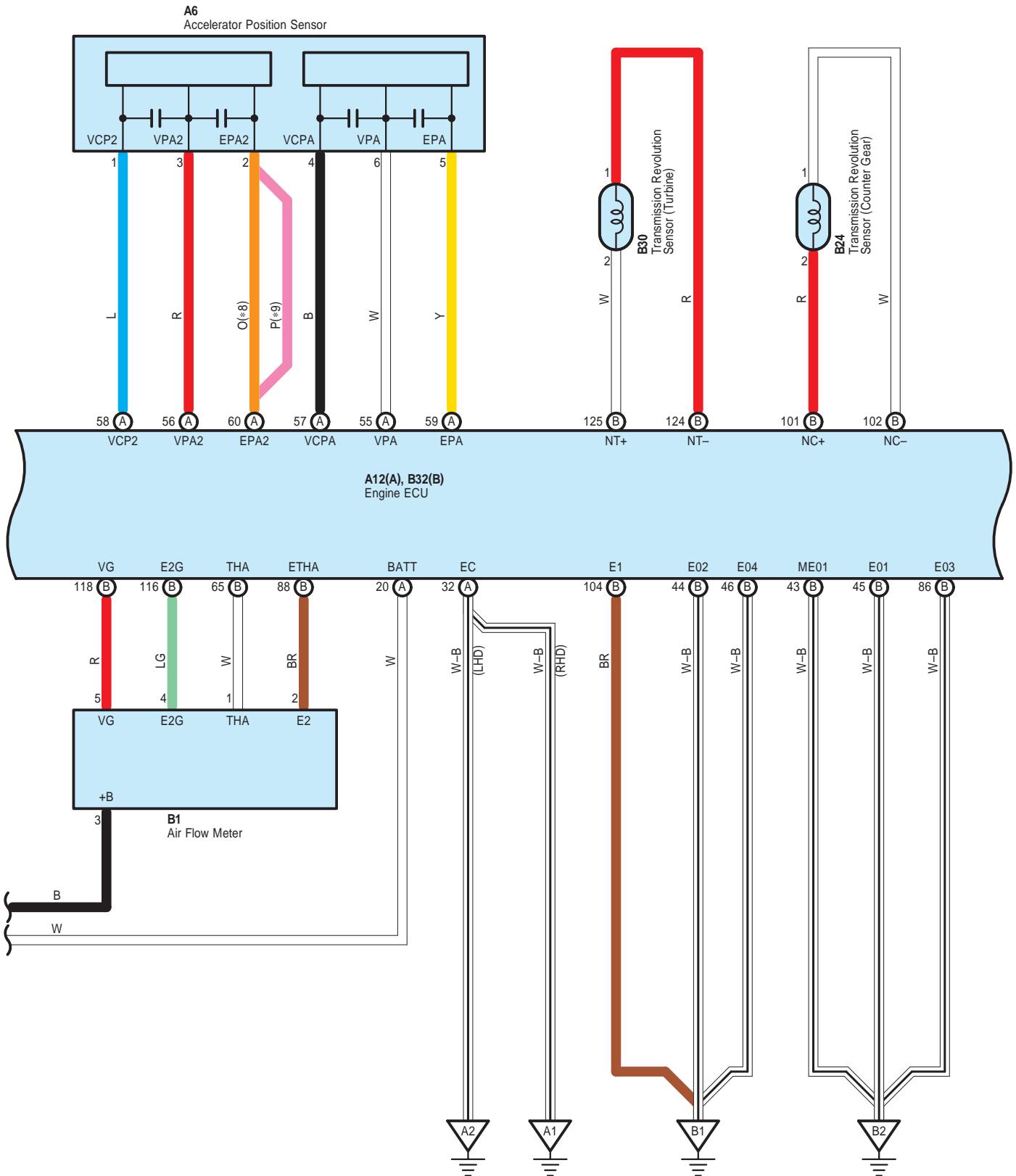

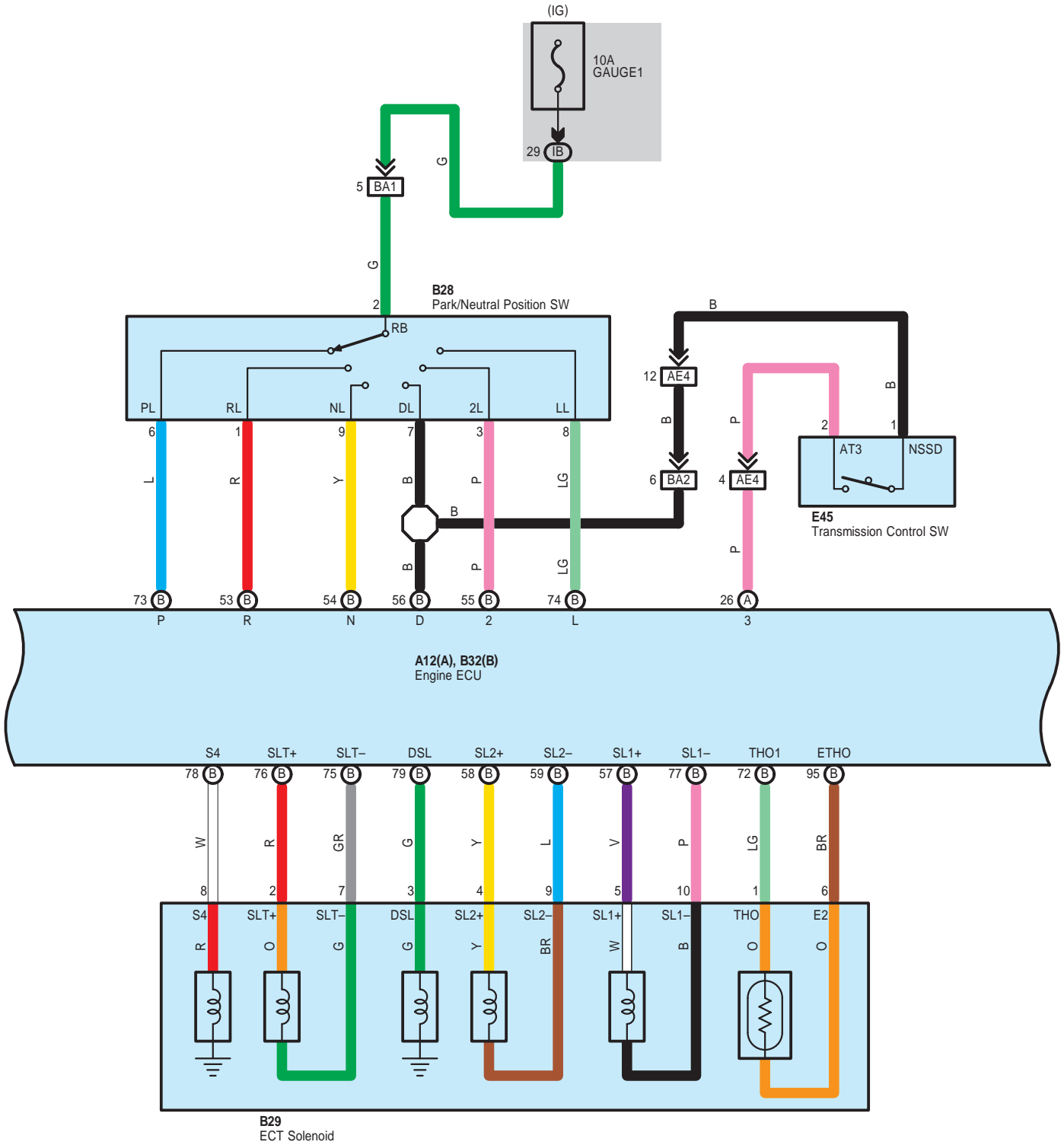

- * 1 : w/ VSC
- * 2 : w/o VSC
- * 3 : Shielded
- * 4 : Australia
- * 5 : RHD Except Australia
- * 8 : Before Aug. 2008 Production Except Europe, Before Dec. 2008 Production Europe
- * 9 : From Aug. 2008 Production Except Europe, From Dec. 2008 Production Europe
- * 10 : Before Feb. 2010 Production
- * 11 : From Feb. 2010 Production

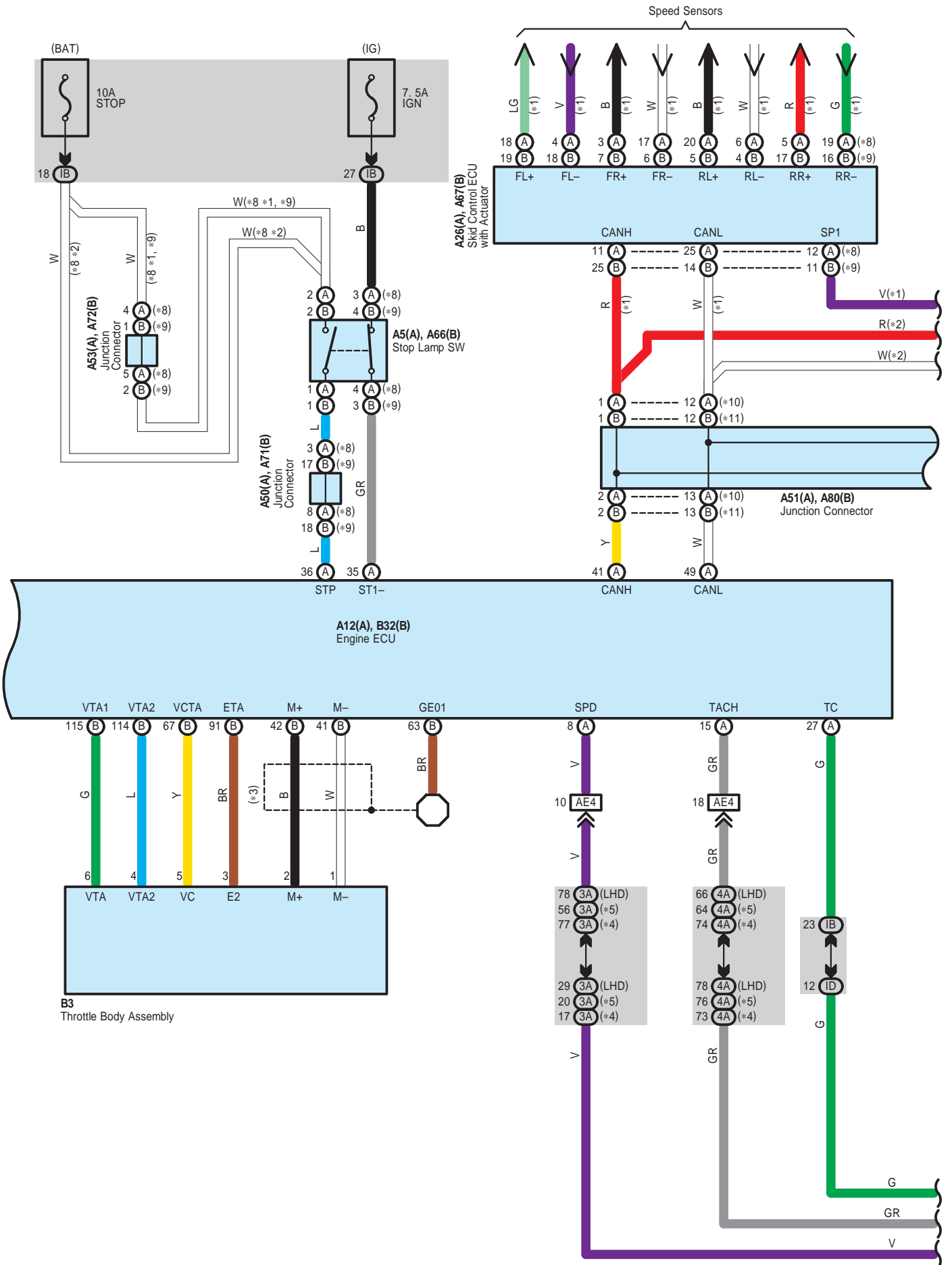

ECT and A/T Indicator <2AZ-FE, 1AZ-FE>

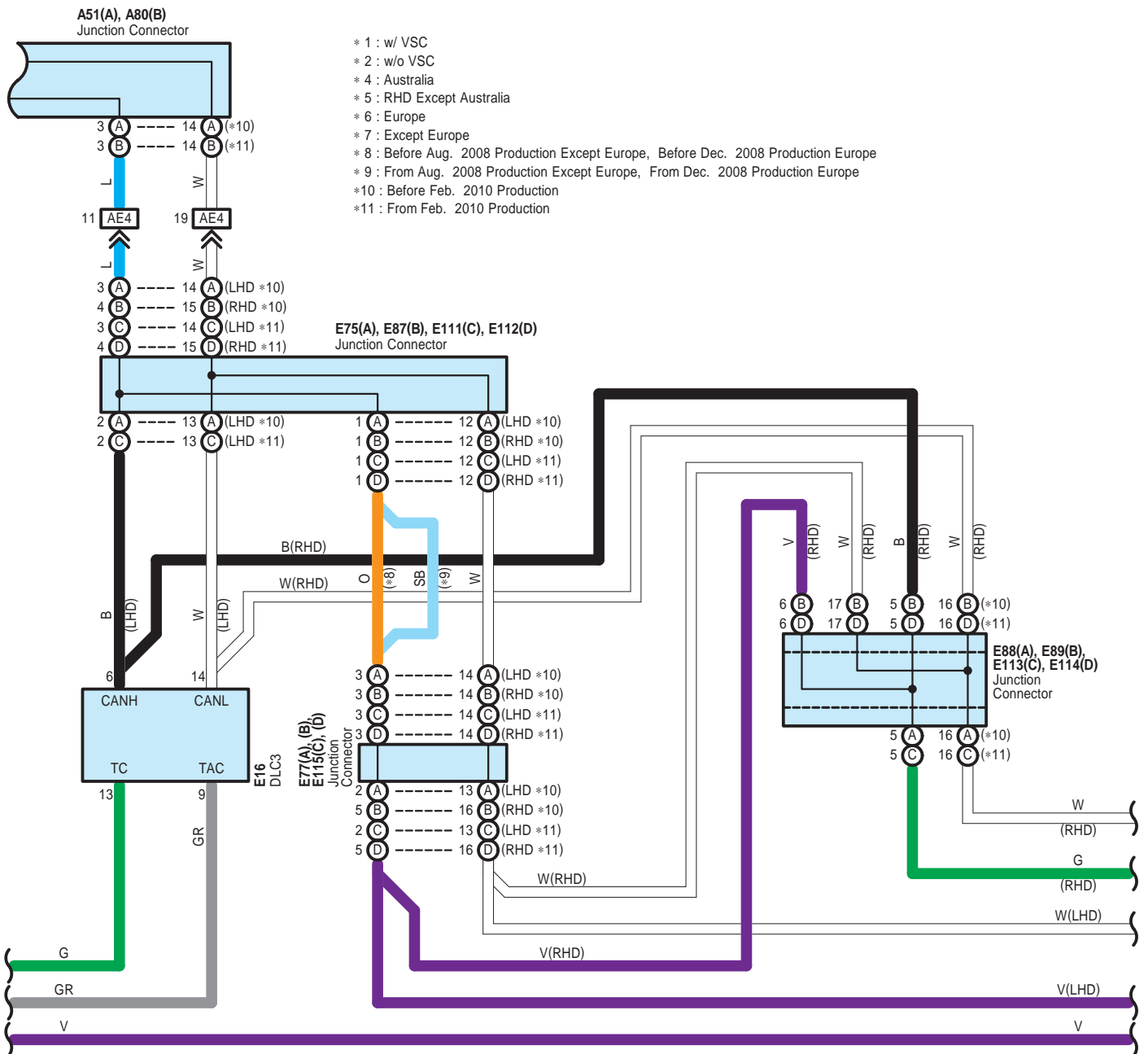
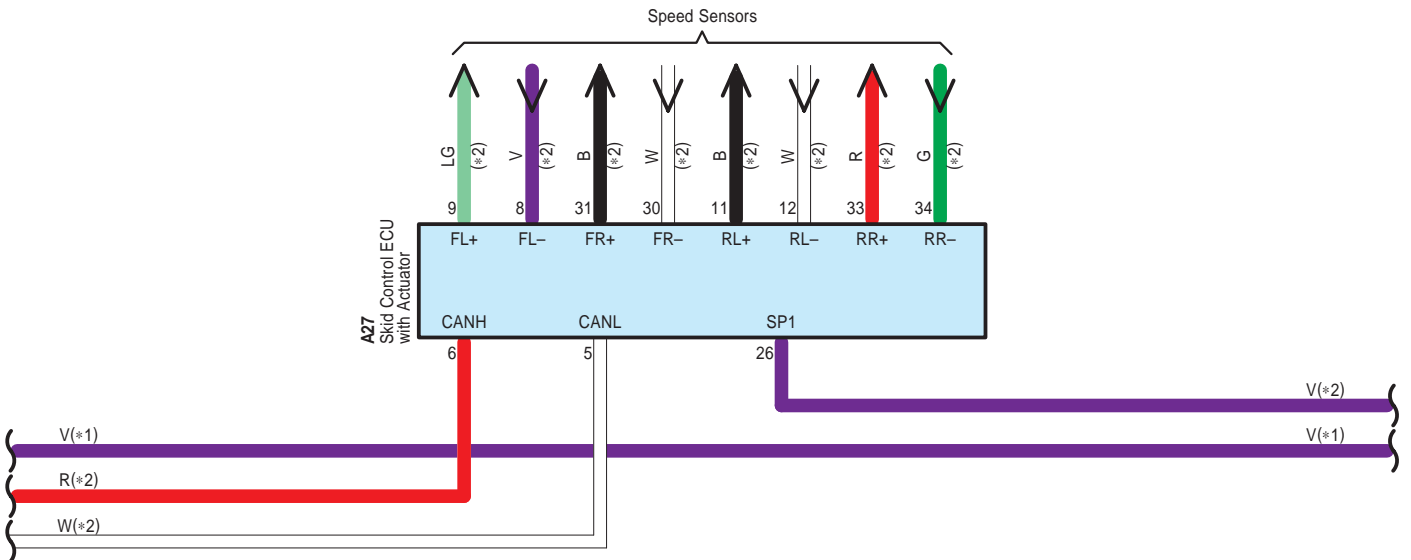

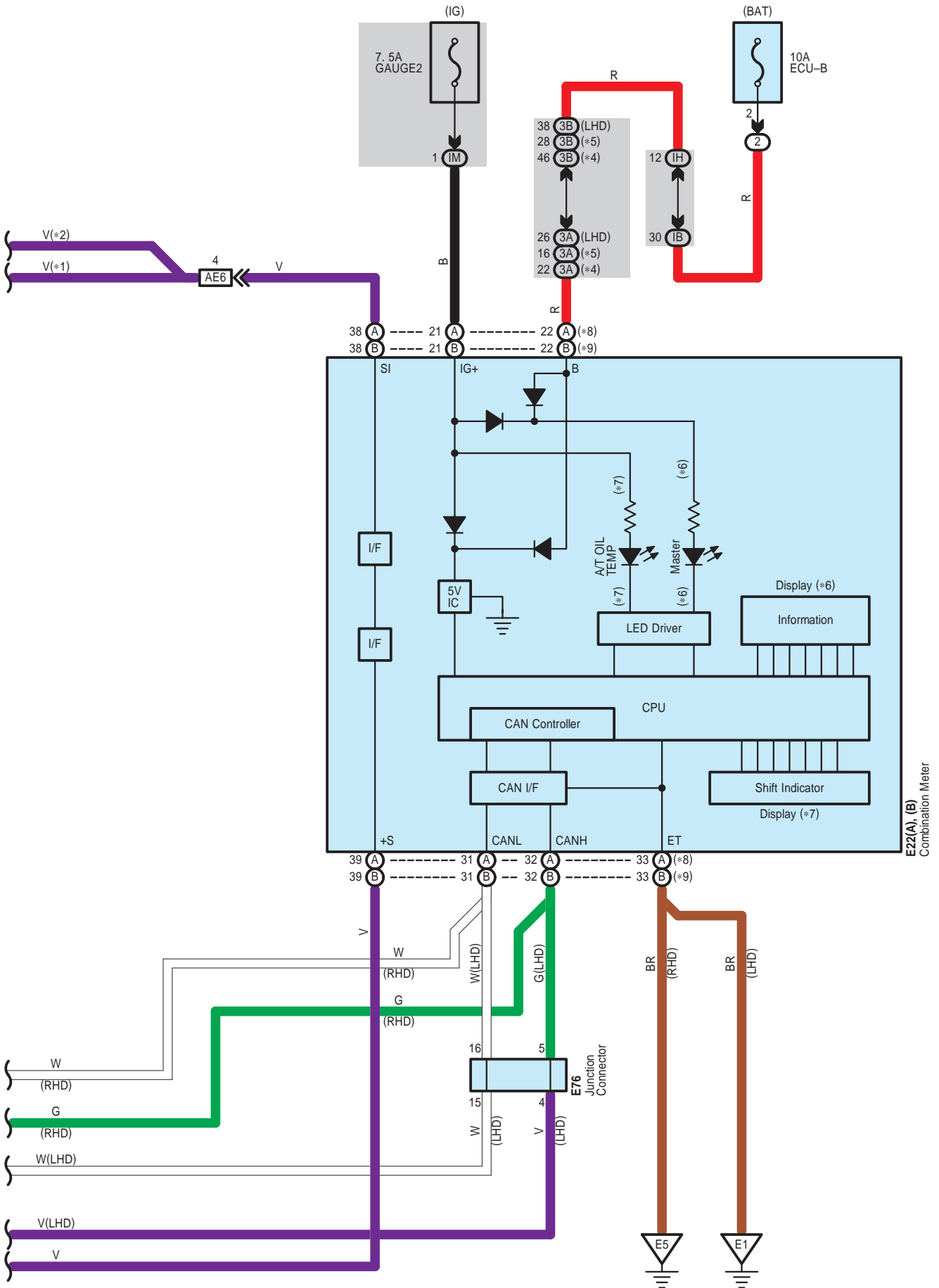

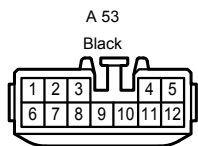
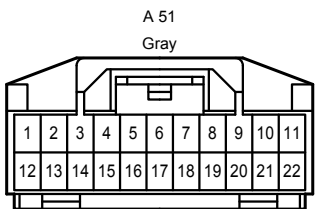
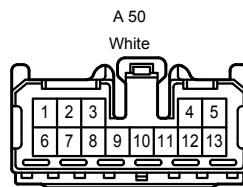
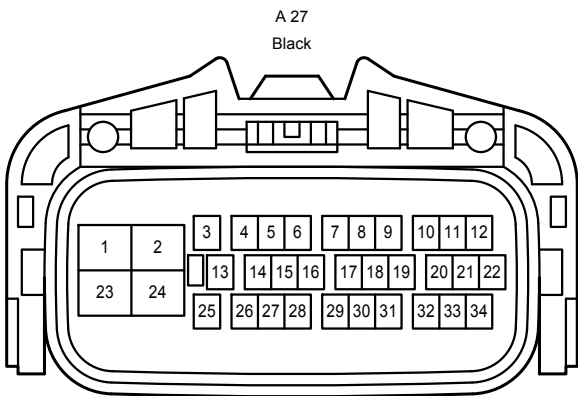
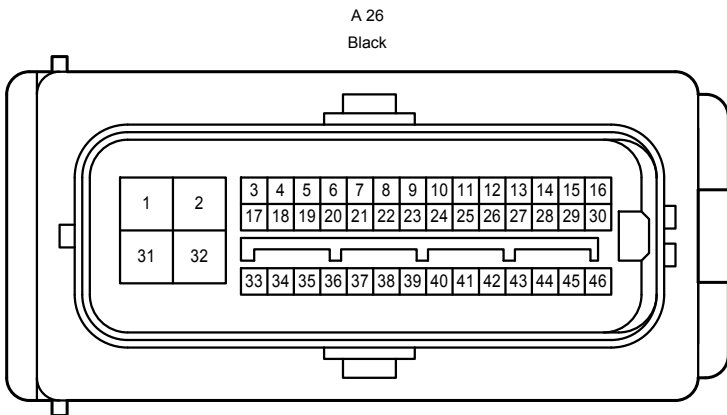
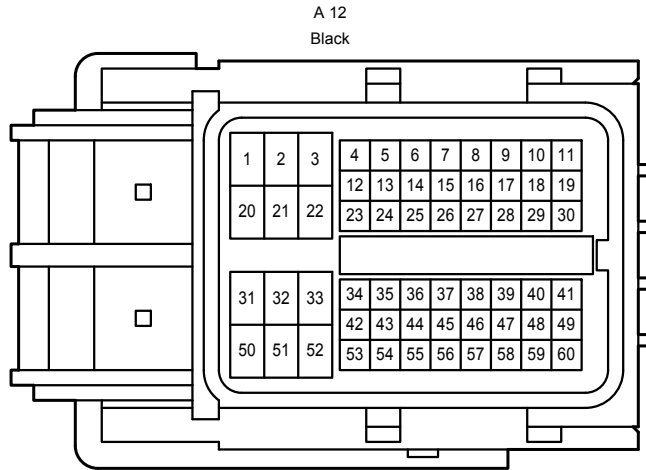
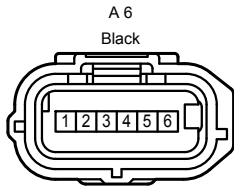
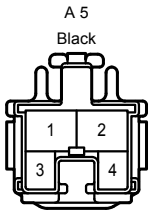

ECT and A/T Indicator <2AZ-FE, 1AZ-FE>

A 67
Black

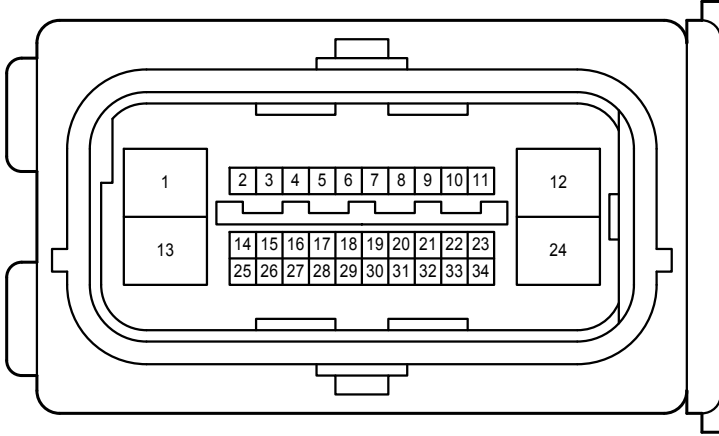

A 71
White

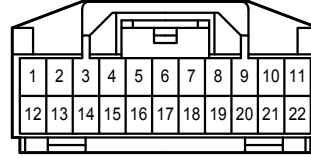

A 72
Gray

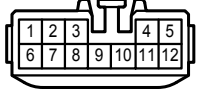

A 80
Gray

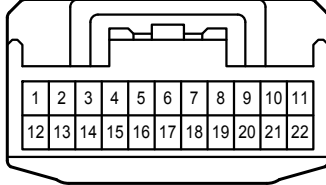

B 1
Black



B 3
Black

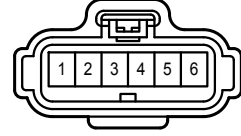

B 4
Gray



B 24
Black

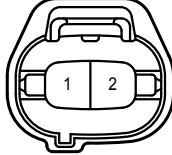

B 28
Gray

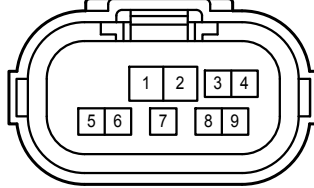

B 29
Gray

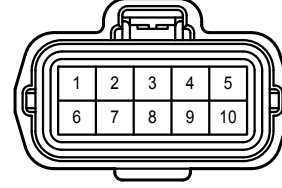

B 30
Black

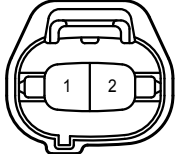

B 32
Black

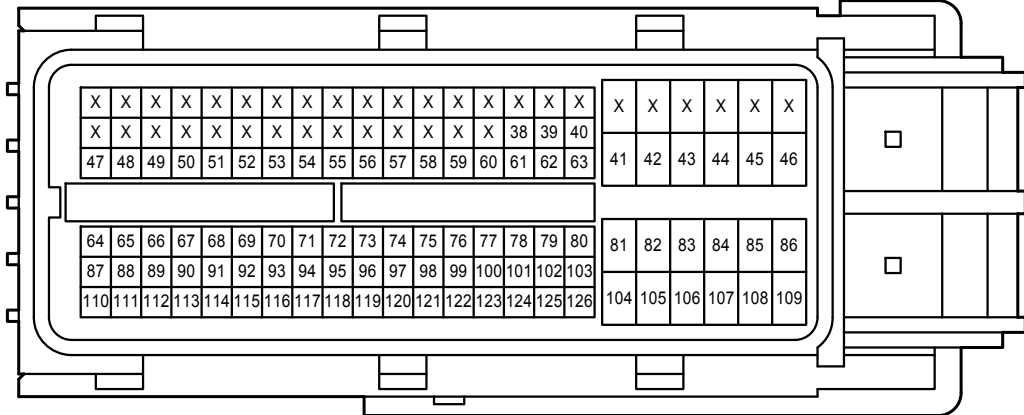

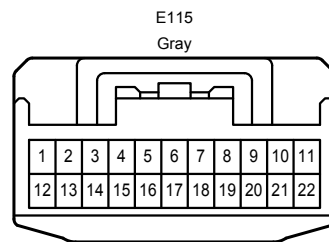
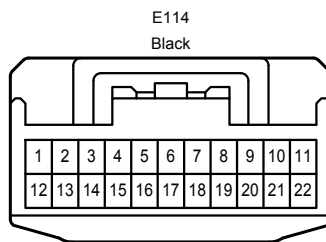
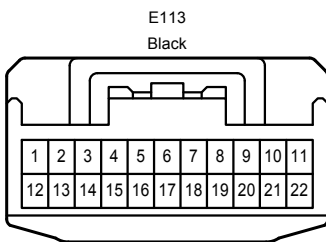
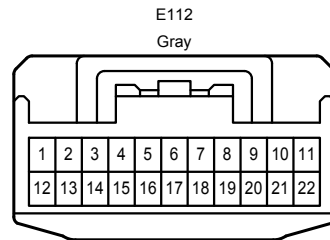
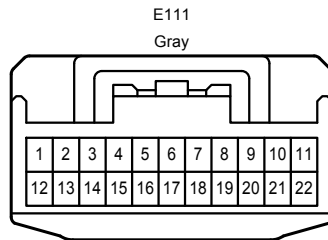
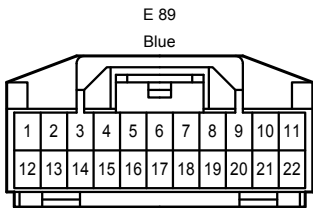
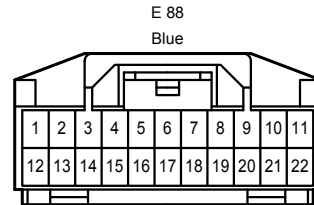
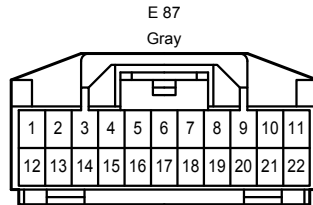
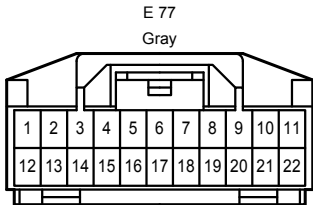
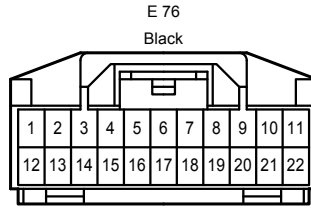
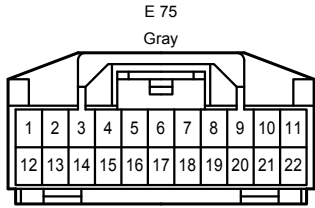
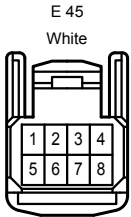
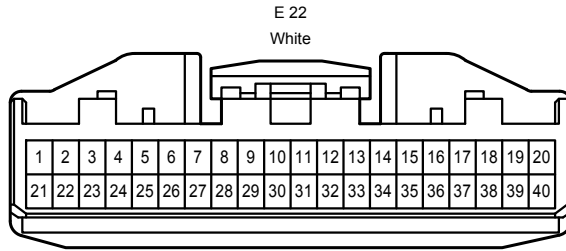
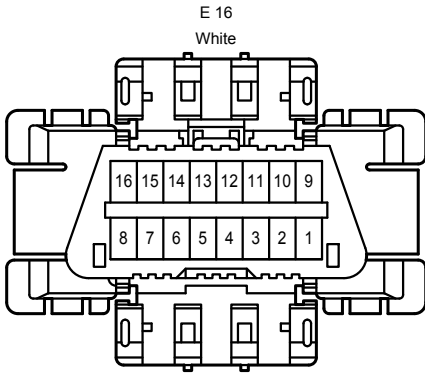

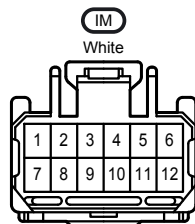
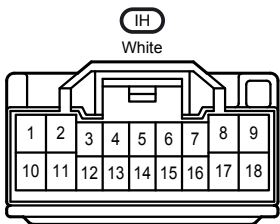
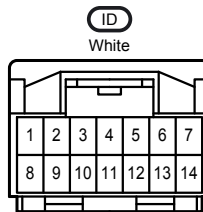
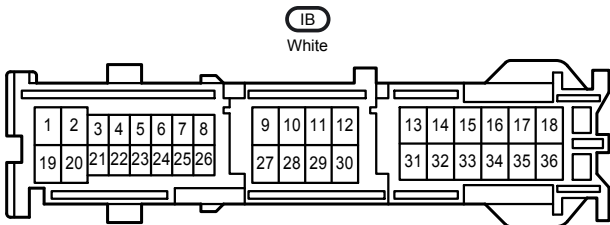
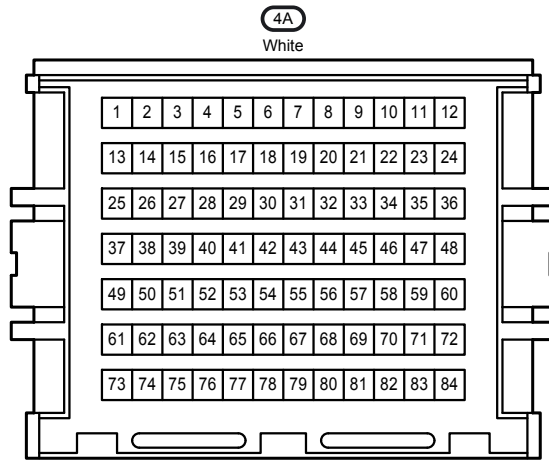
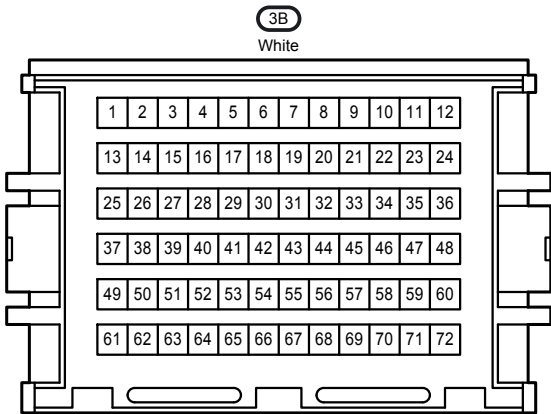
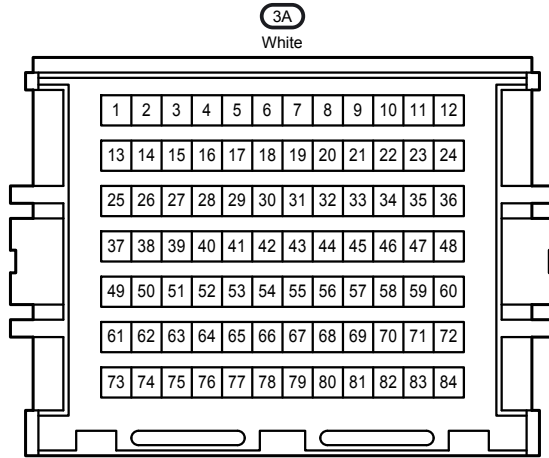
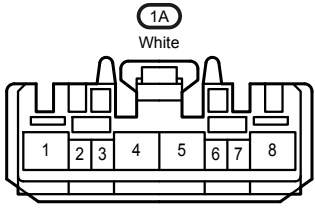

AE4
Gray

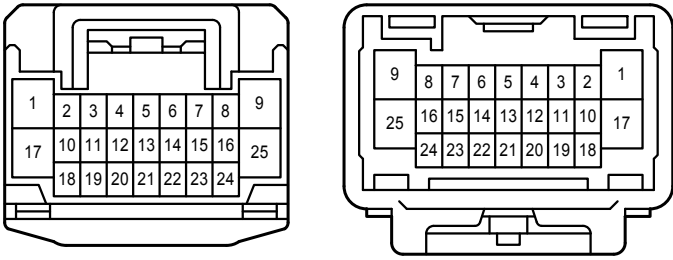

AE6
White

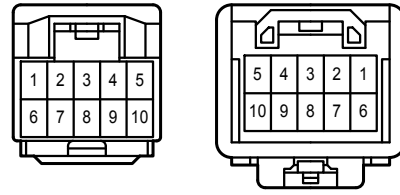

BA1
White

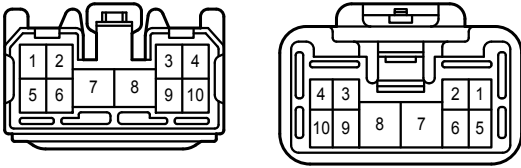

BA2
Gray

