

ECT and A/T Indicator <2GR-FE>

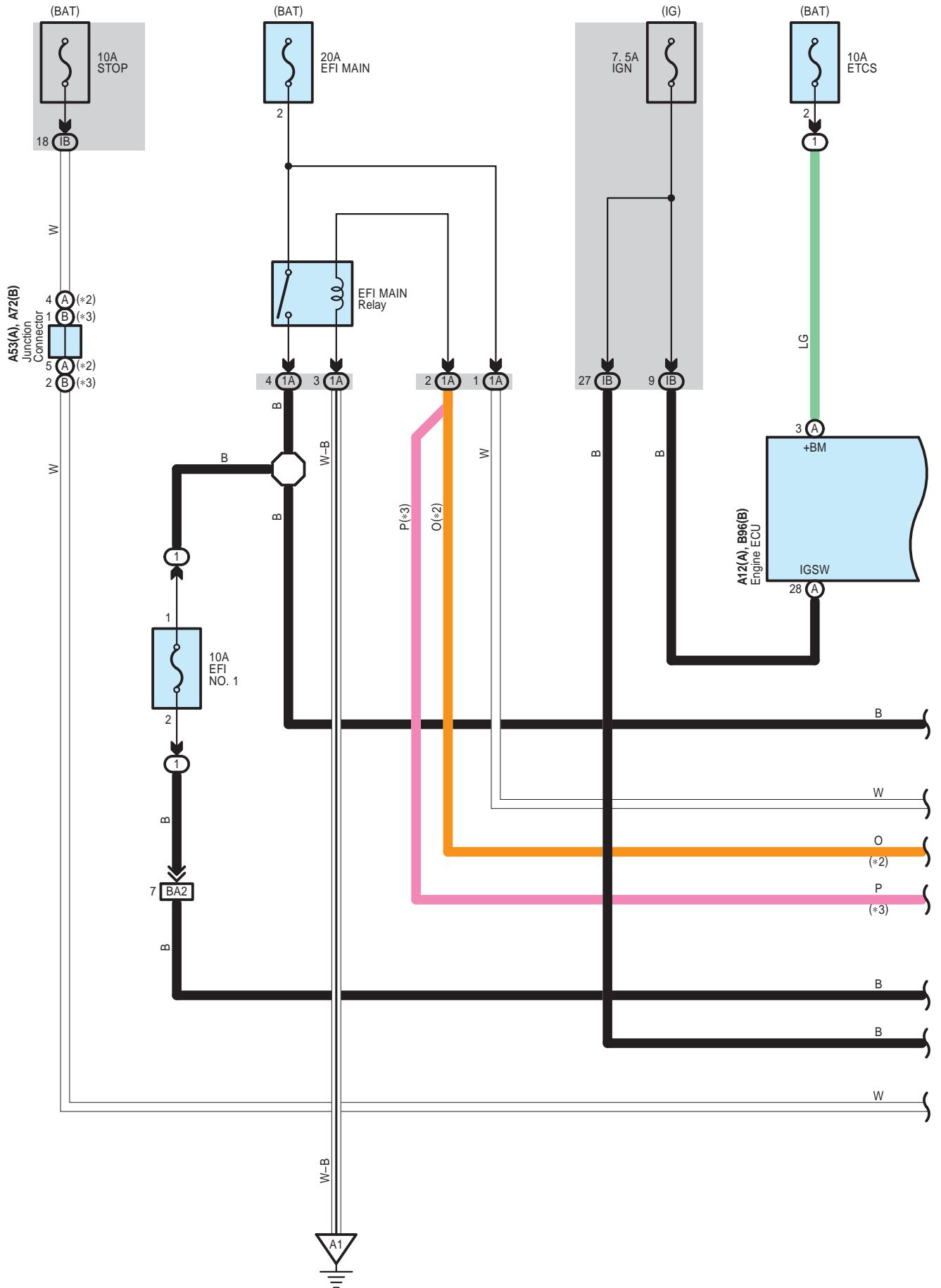

ECT and A/T Indicator <2GR-FE>

- * 1 : Shielded
- * 2 : Before Aug. 2008 Production
- * 3 : From Aug. 2008 Production

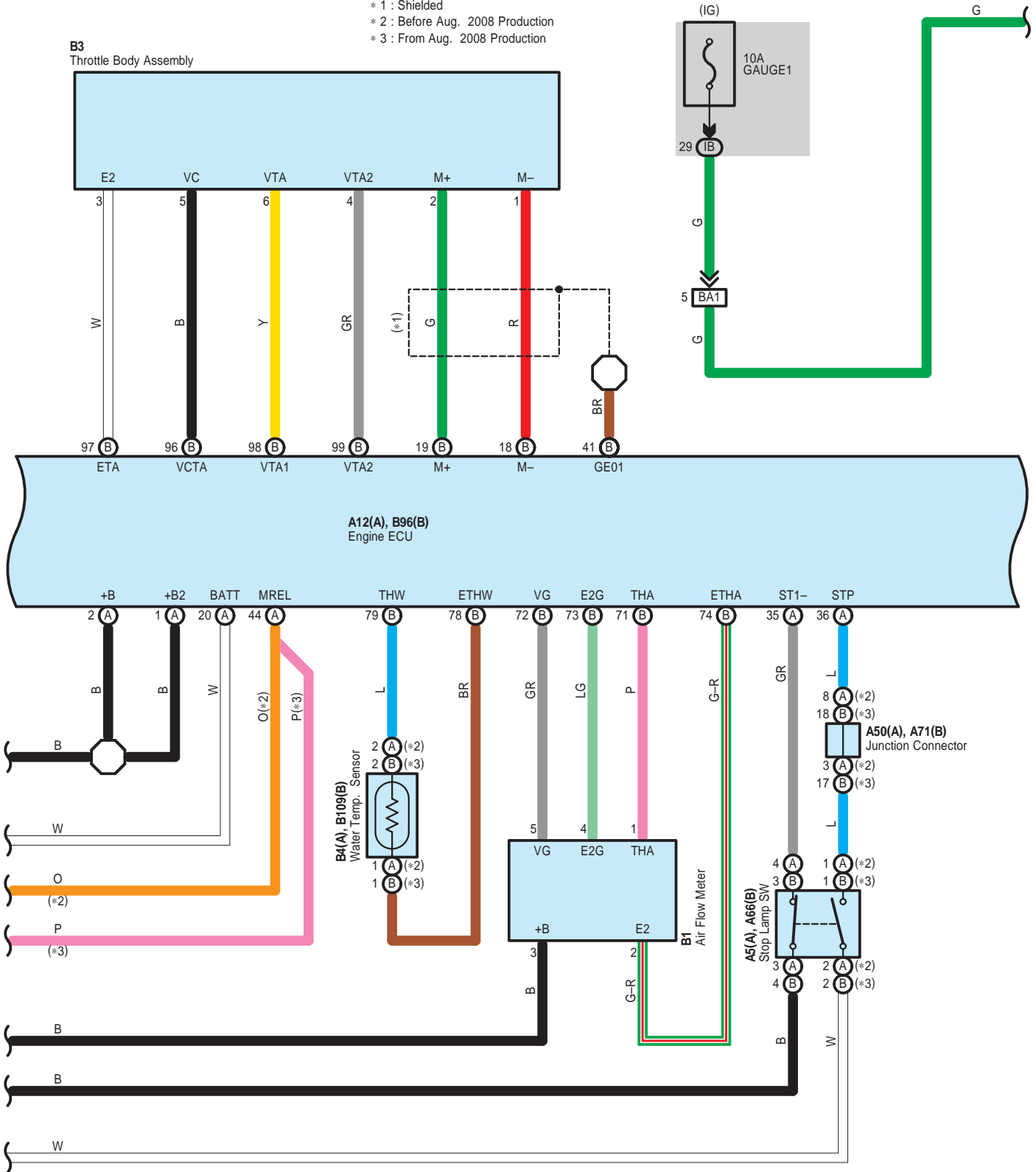

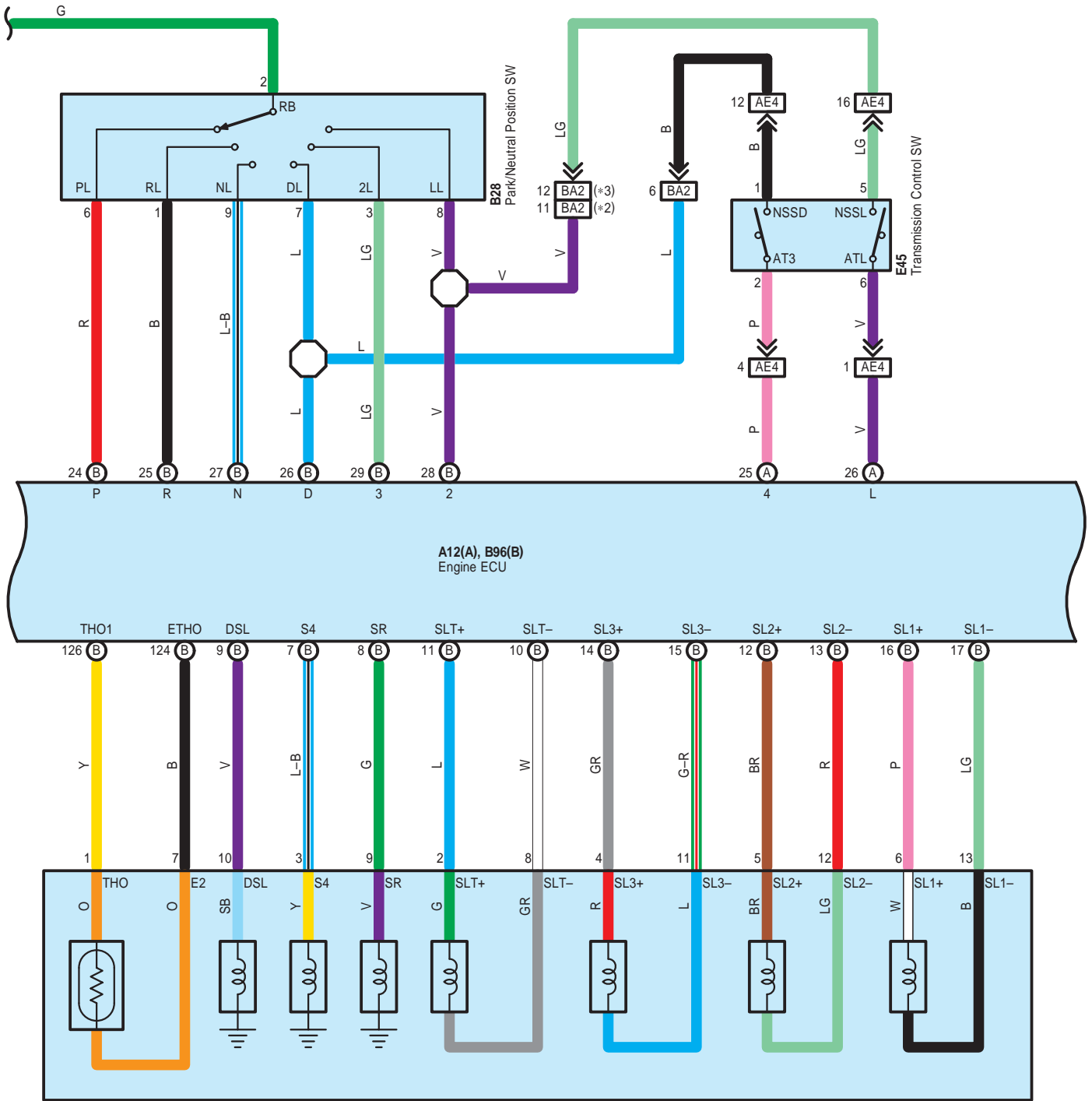

B66
ECT Solenoid

- * 2 : Before Aug. 2008 Production
- * 3 : From Aug. 2008 Production

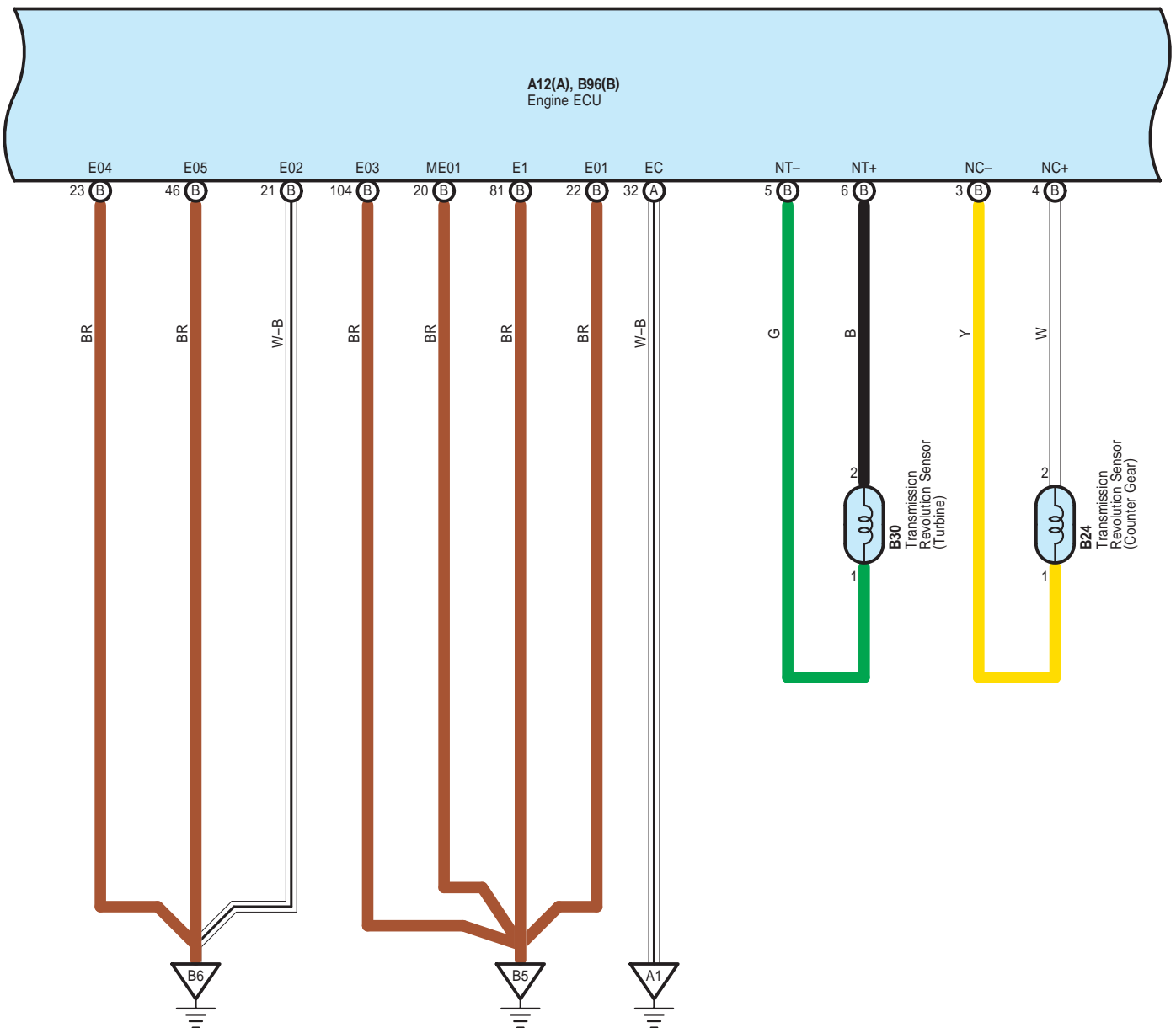

ECT and A/T Indicator <2GR-FE>

- * 2 : Before Aug. 2008 Production
- * 3 : From Aug. 2008 Production
- * 4 : Before Feb. 2010 Production
- * 5 : From Feb. 2010 Production

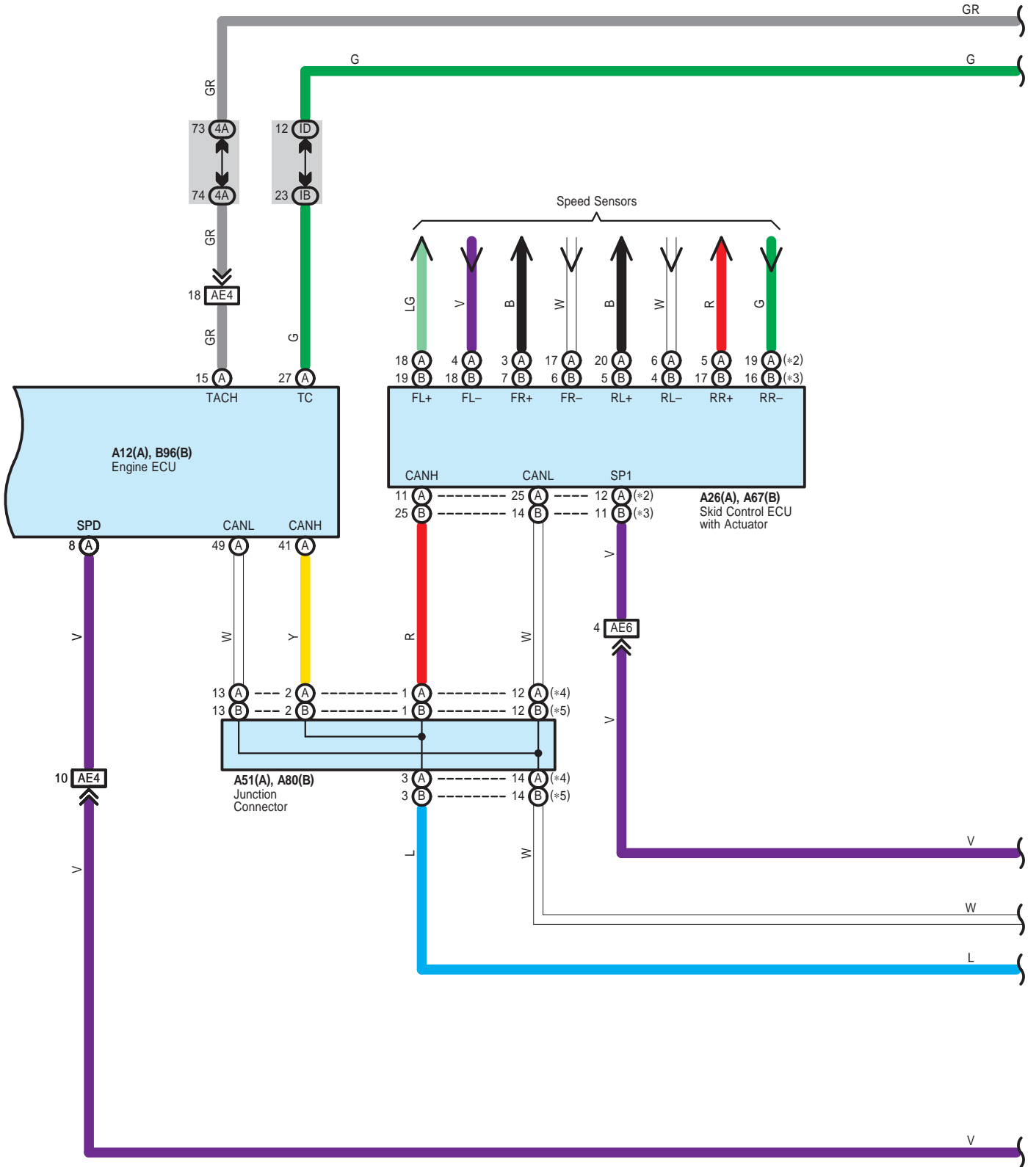

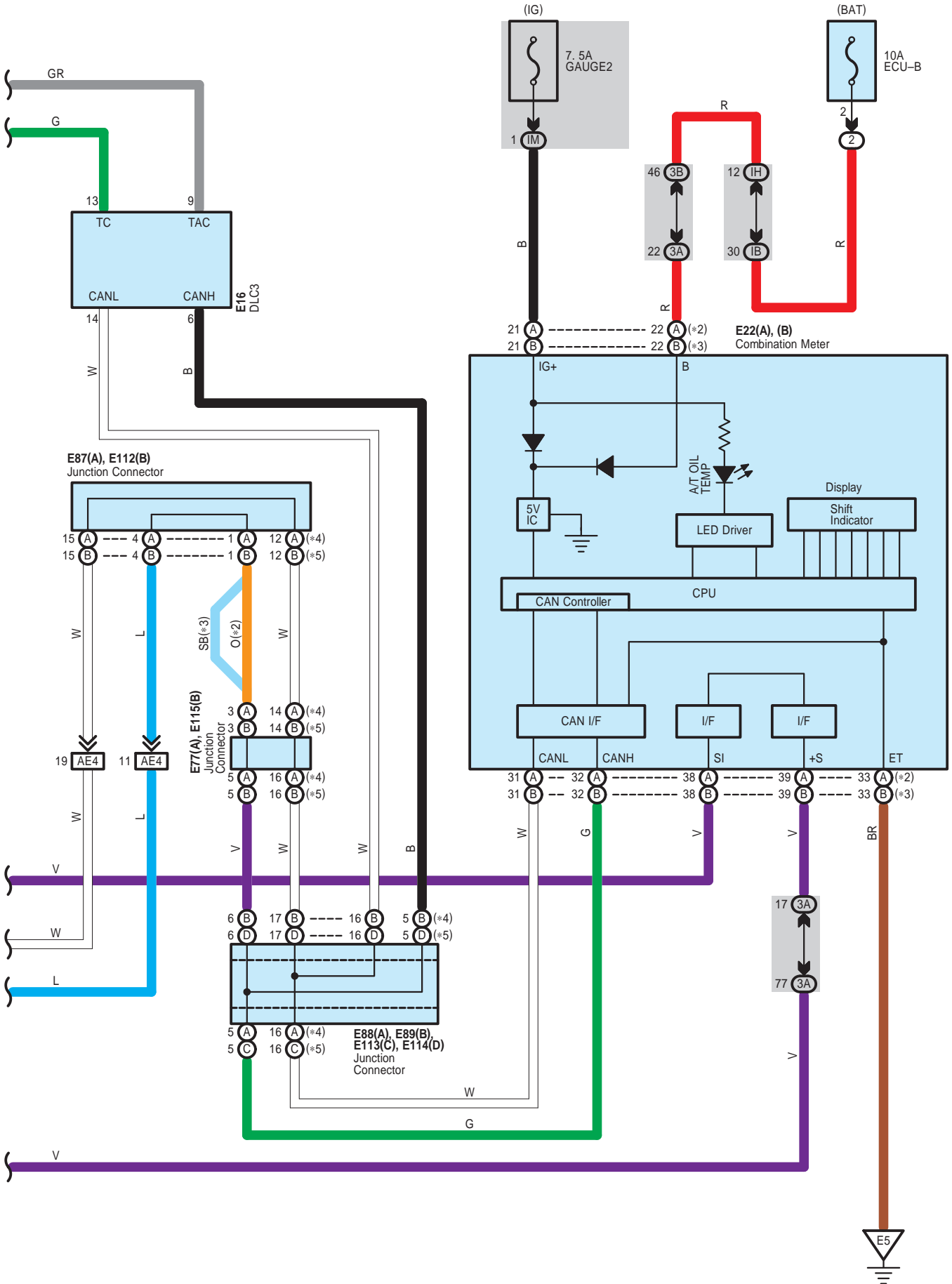

ECT and A/T Indicator <2GR-FE>

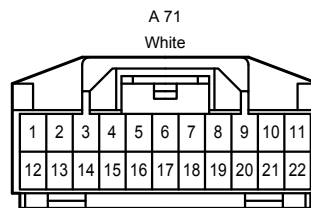
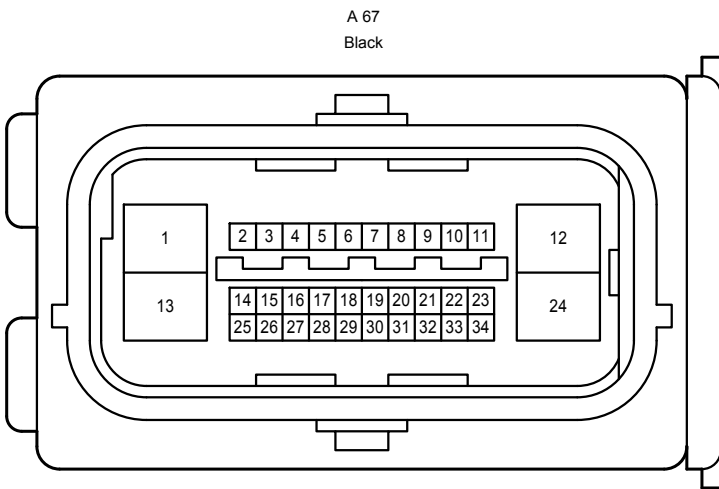
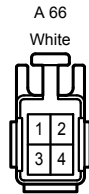
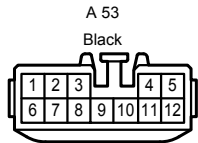
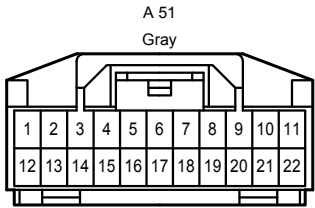
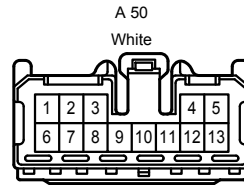
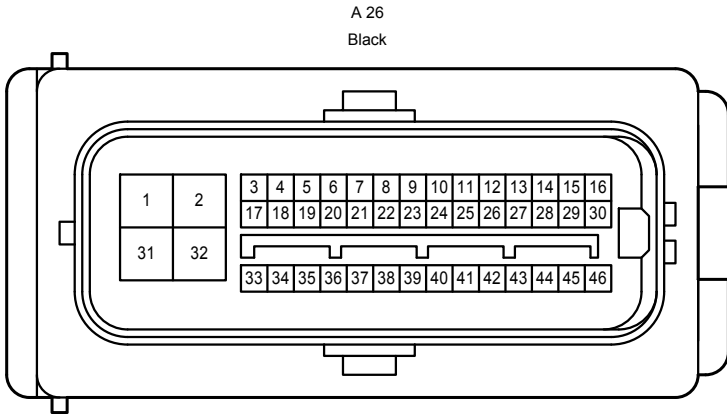
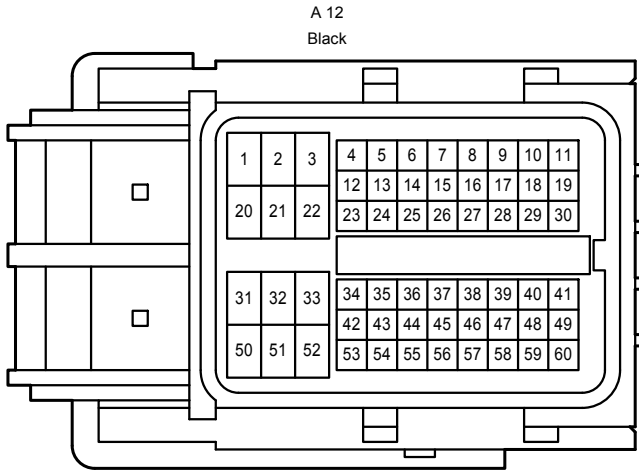
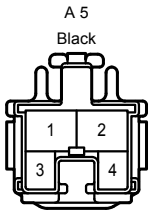

ECT and A/T Indicator <2GR-FE>

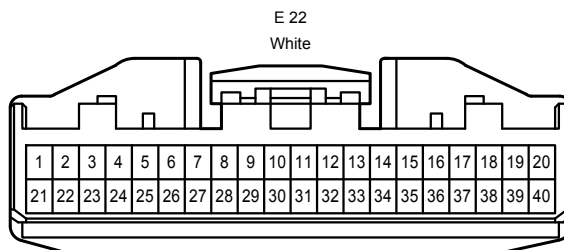
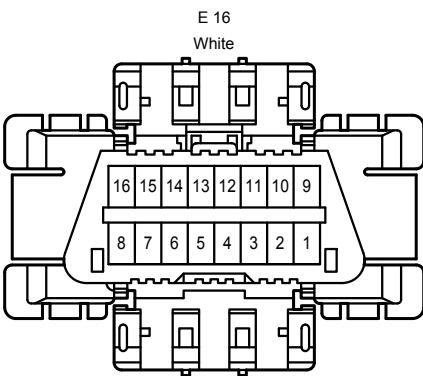
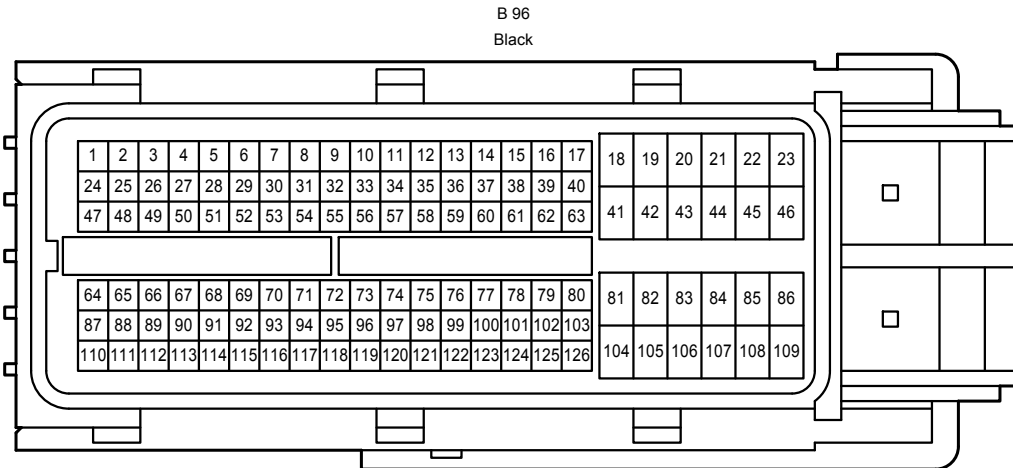
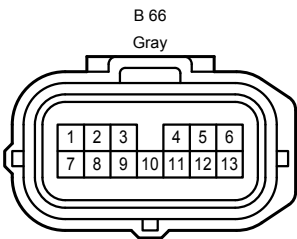
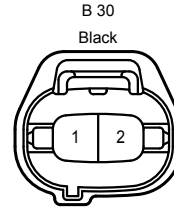
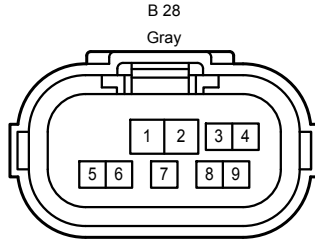
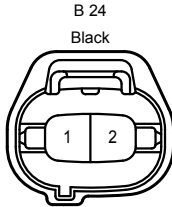
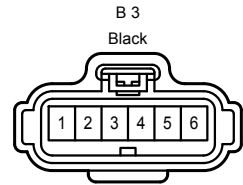
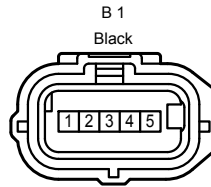
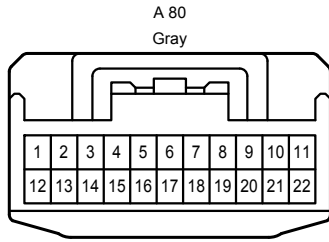
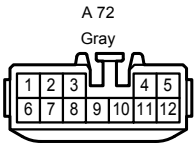

ECT and A/T Indicator <2GR-FE>

E 45
White

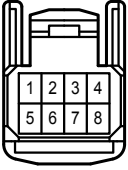

E 77
Gray

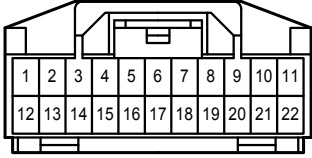

E 87
Gray

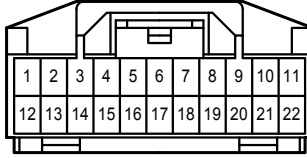

E 88
Blue

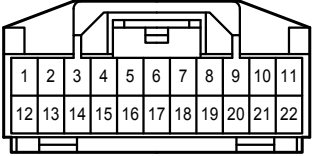

E 89
Blue

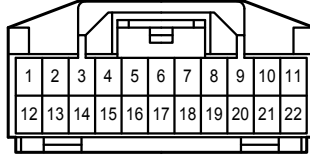

E112
Gray

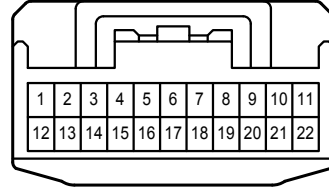

E113
Black

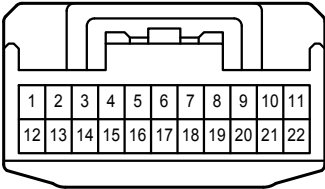

E114
Black

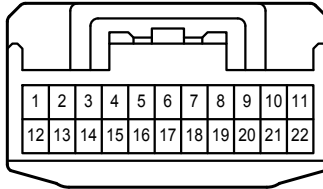

E115
Gray

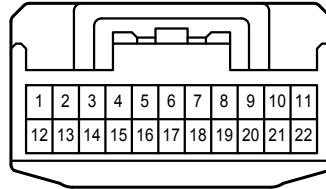

1A
White

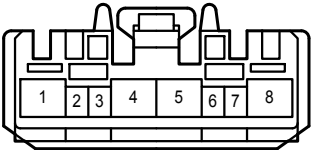

3A
White

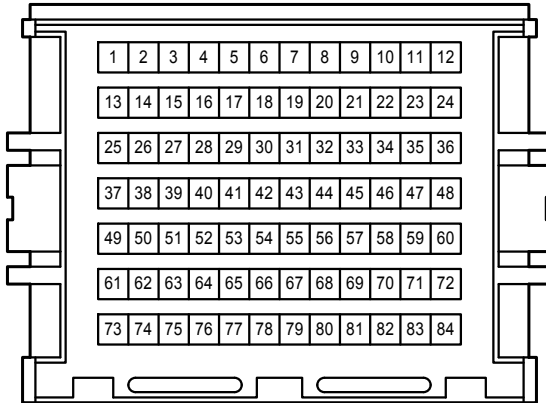

3B
White

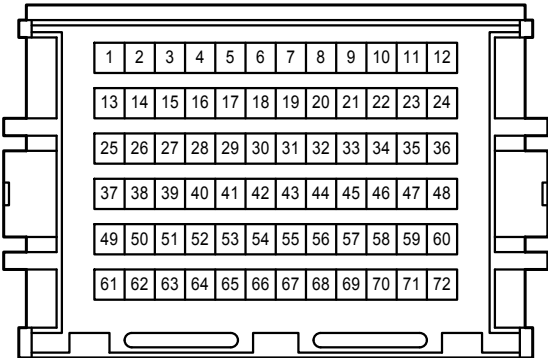

4A
White

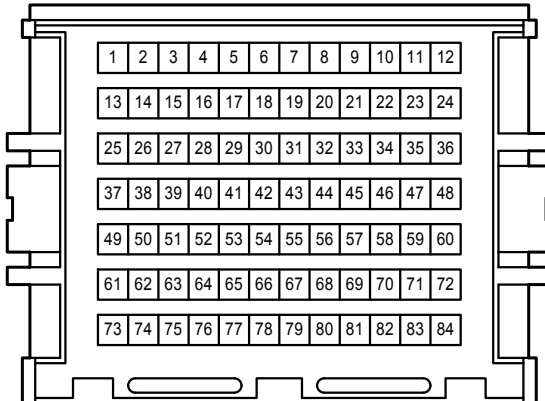

IB
White

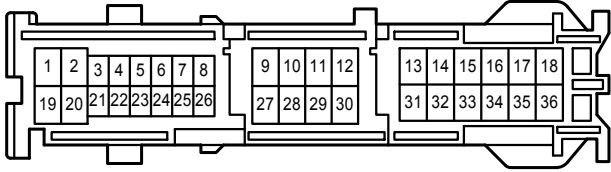

ID
White

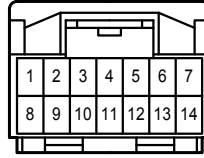

IH
White

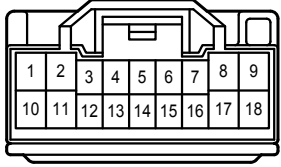

IM
White

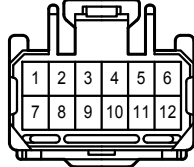

AE4
Gray

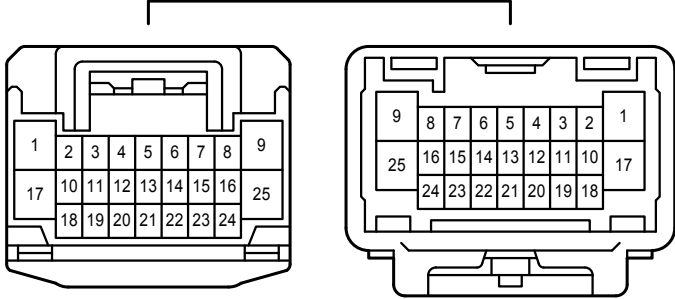

AE6
White

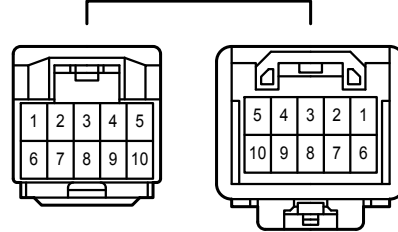

BA1
White

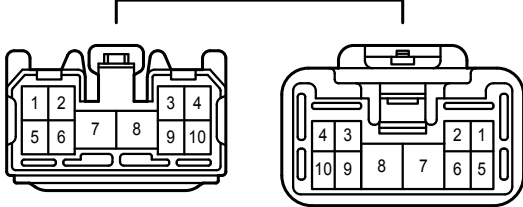

BA2
Gray

