

CVT , Shift Indicator

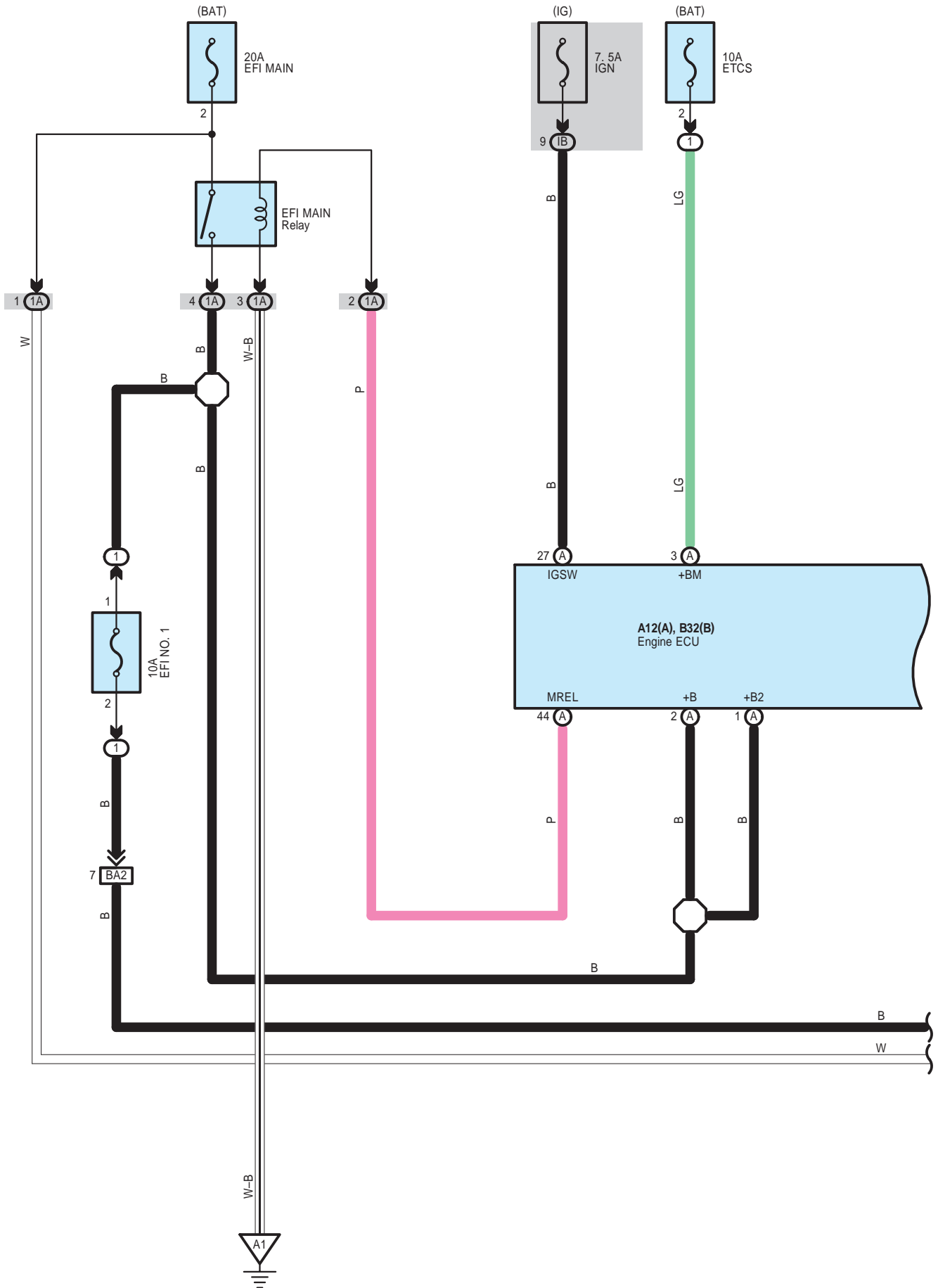

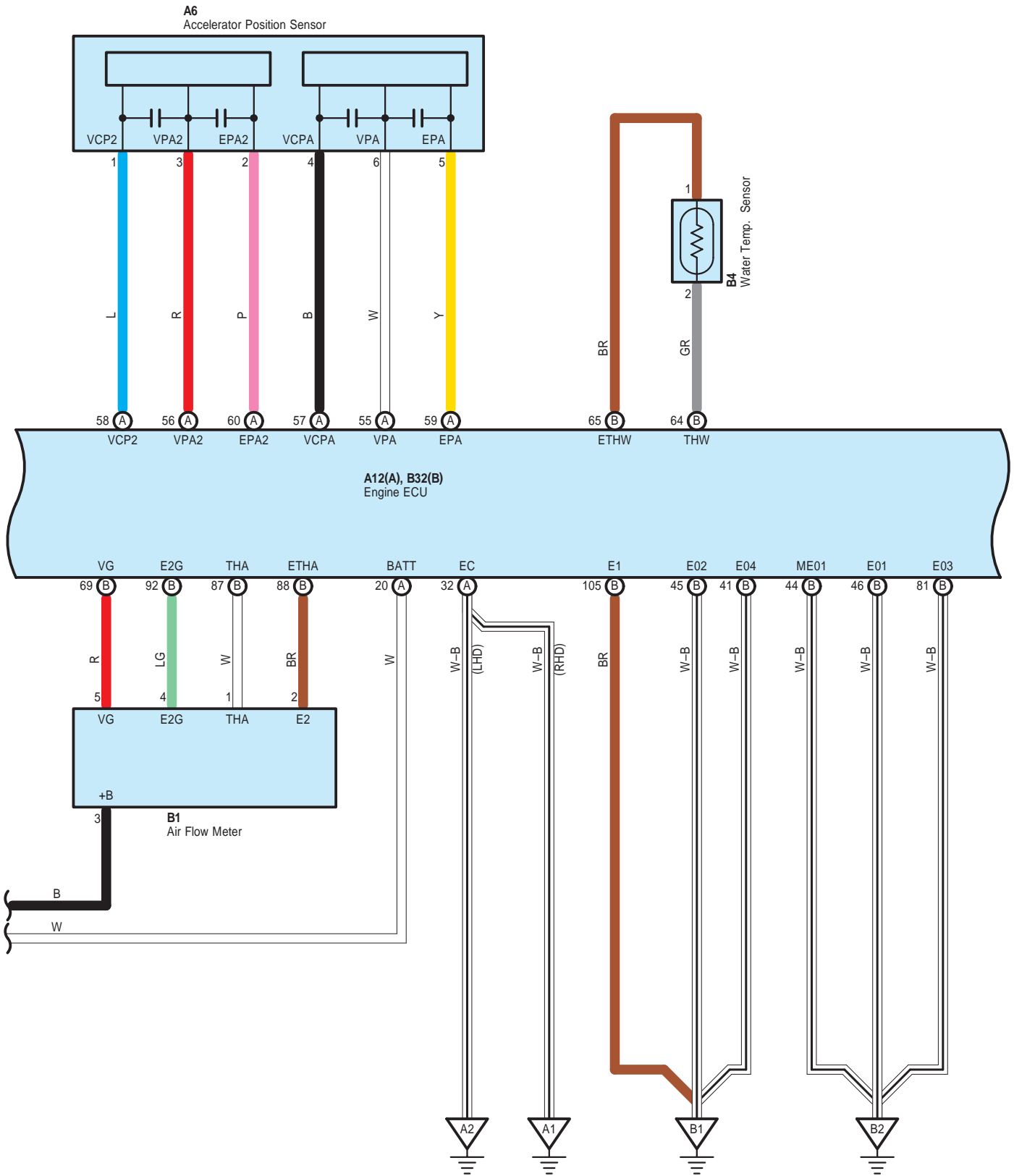

CVT , Shift Indicator

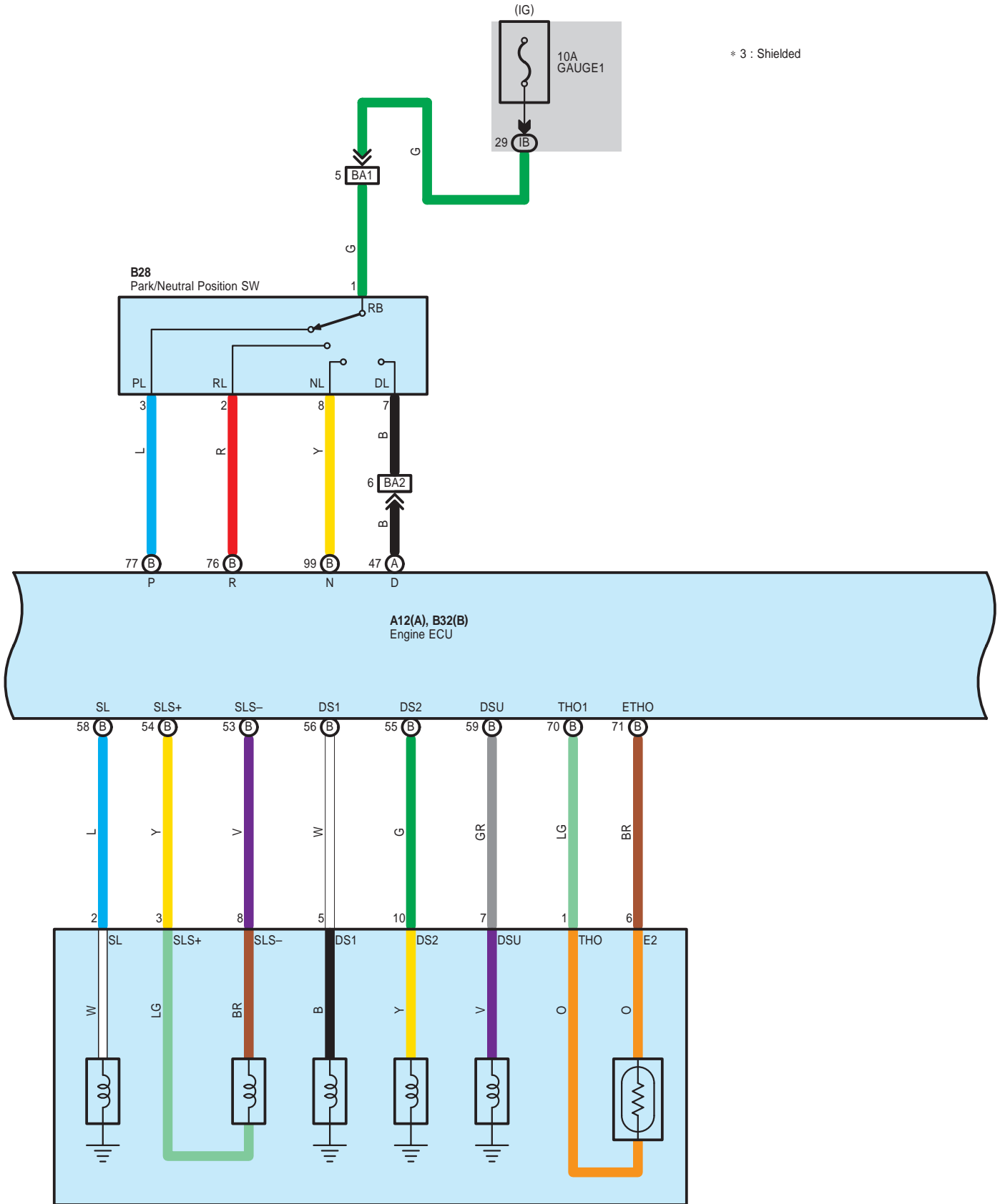

B29
ECT Solenoid

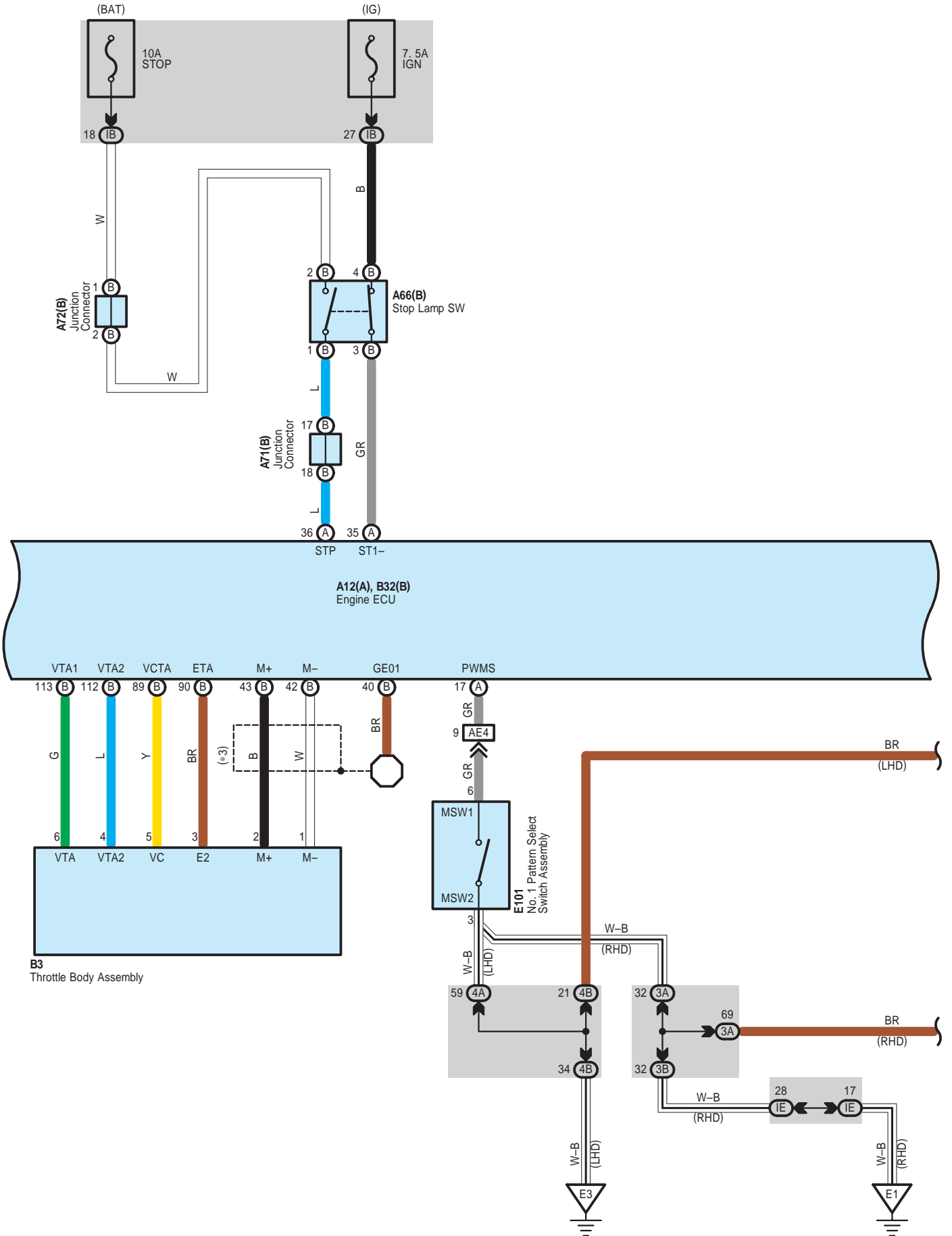

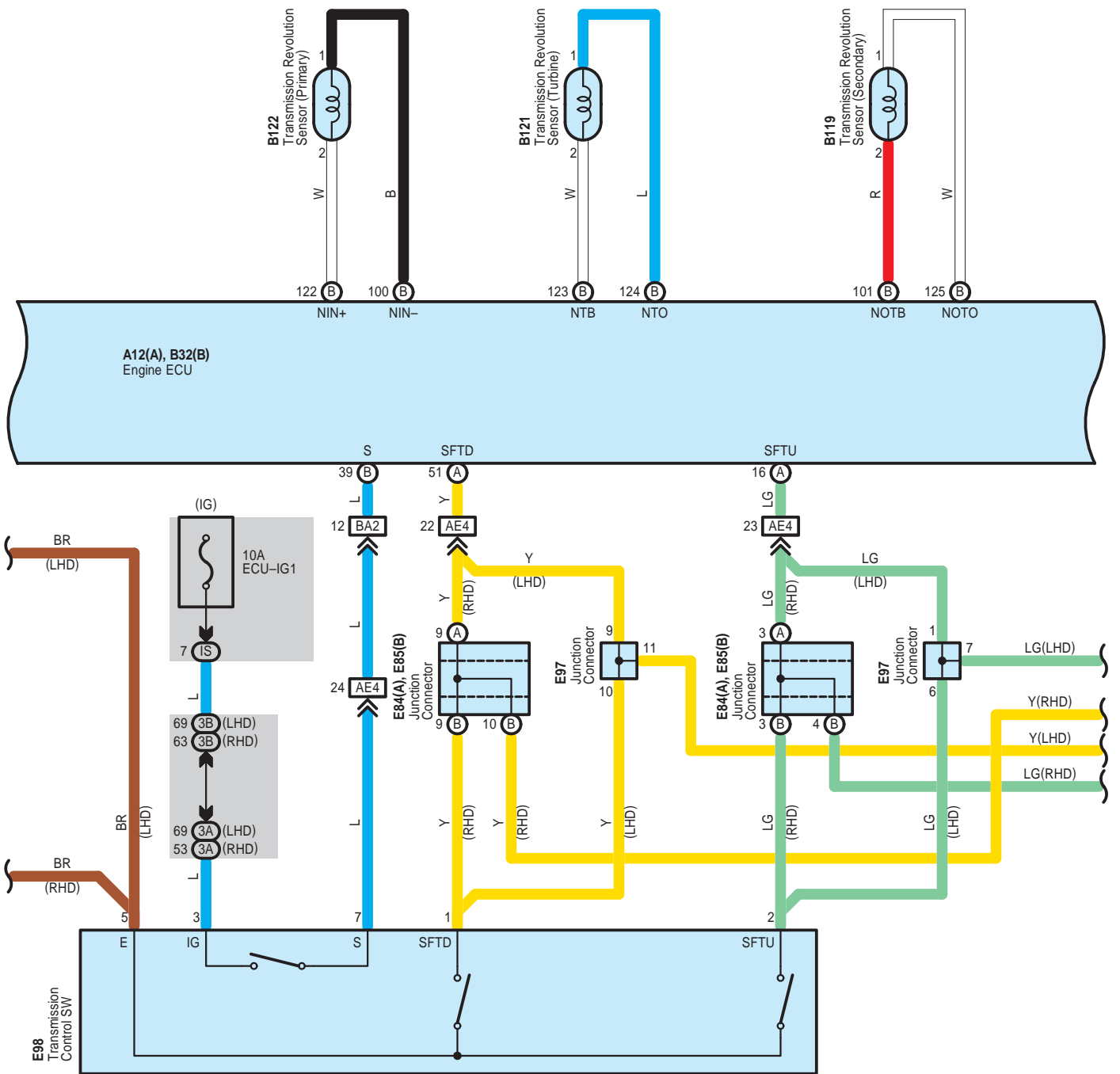

- * 1 : w/ VSC
- * 2 : w/o VSC
- * 4 : Before Feb. 2010 Production
- * 5 : From Feb. 2010 Production

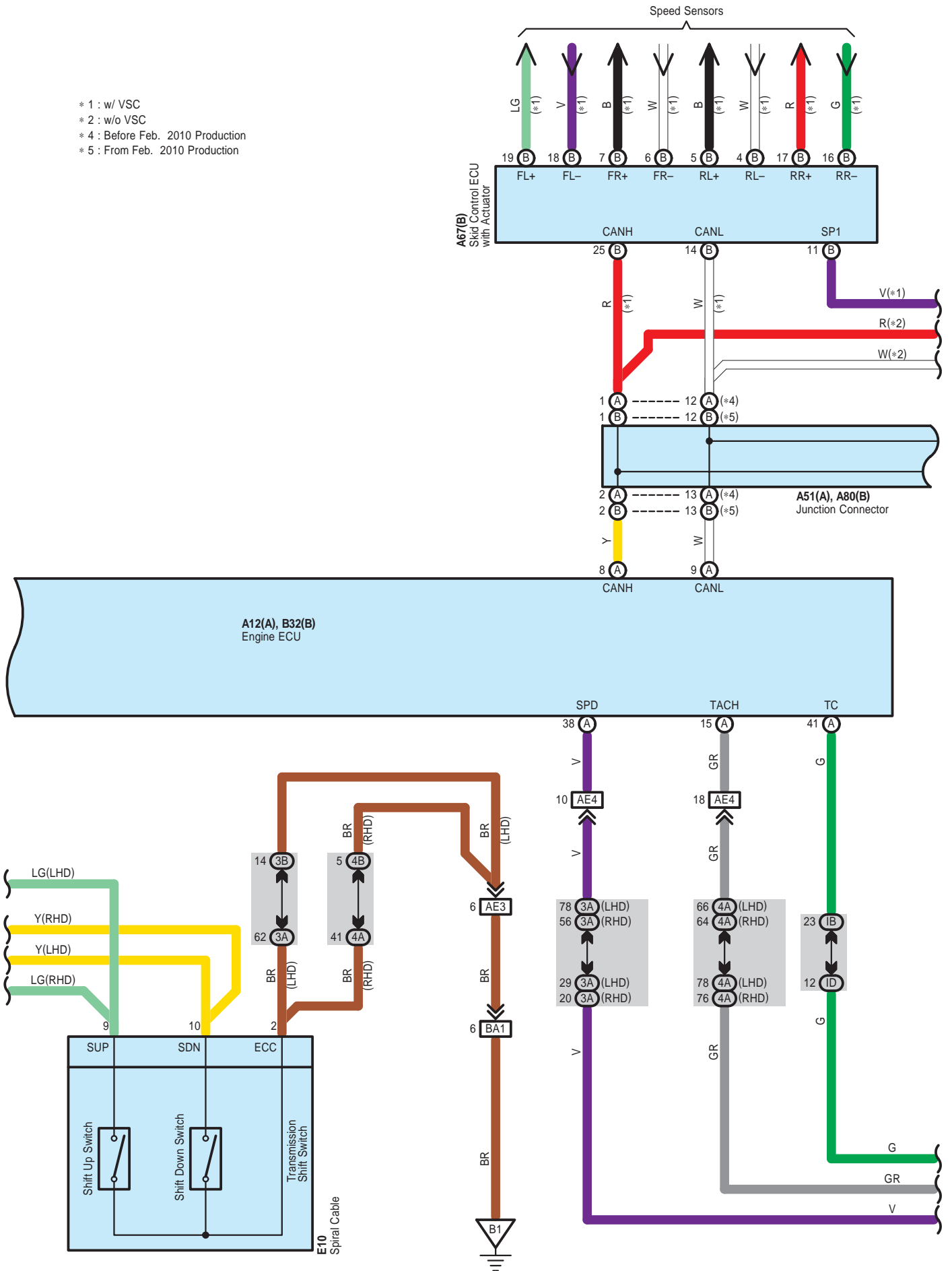

CVT, Shift Indicator

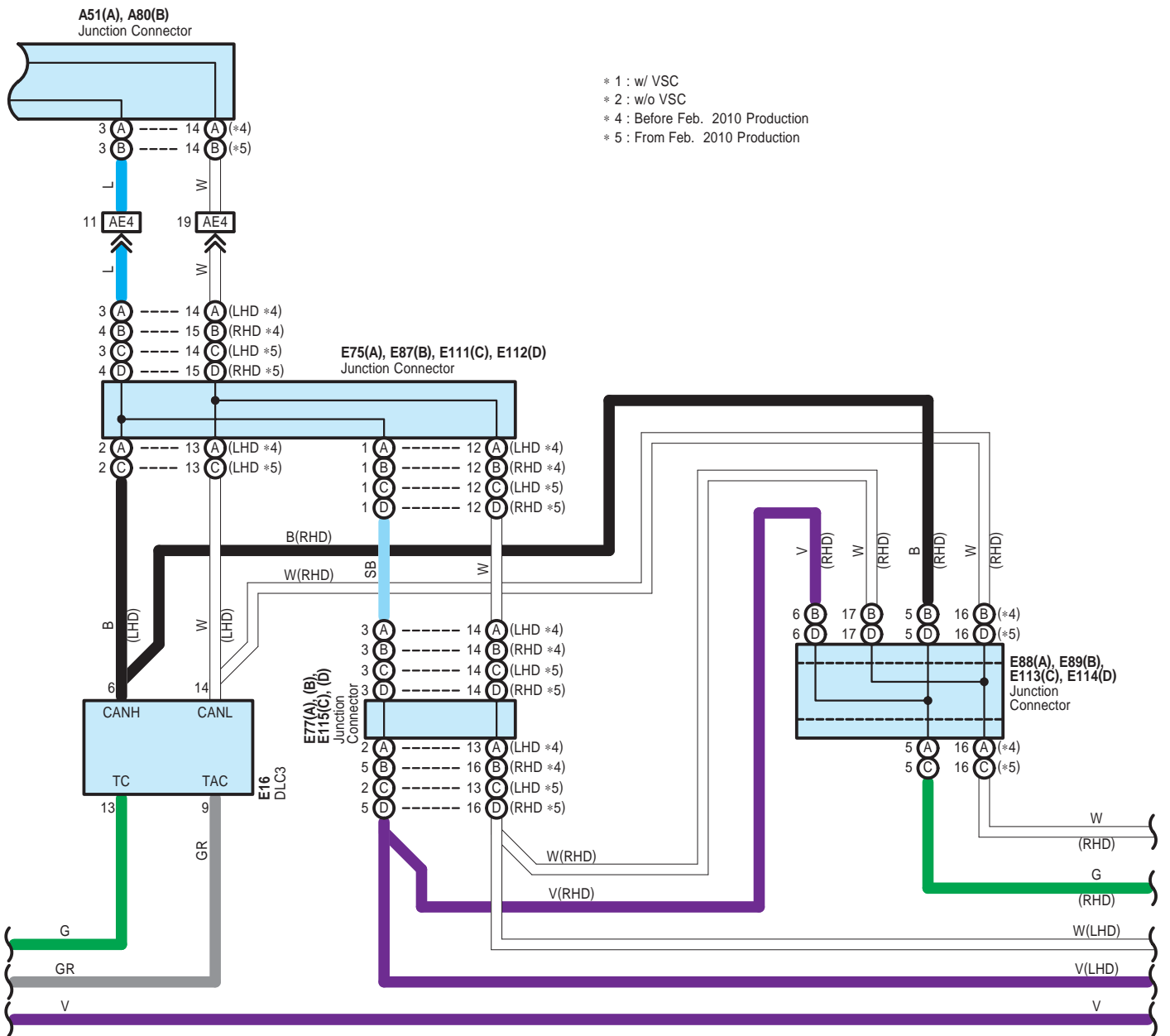
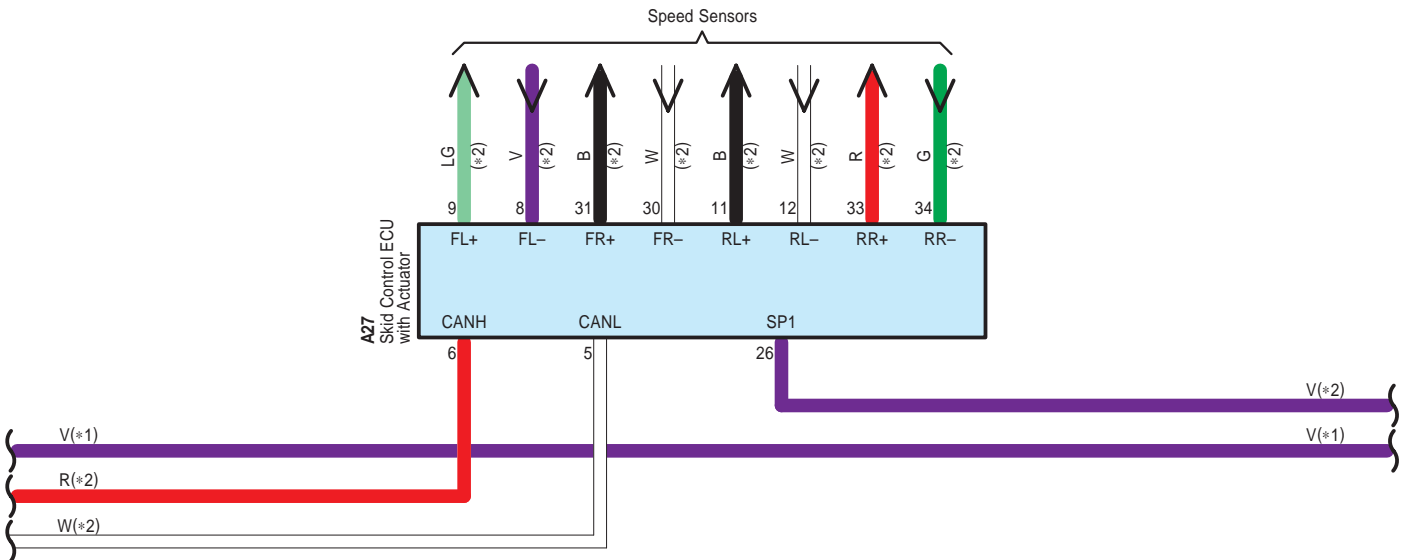

CVT , Shift Indicator

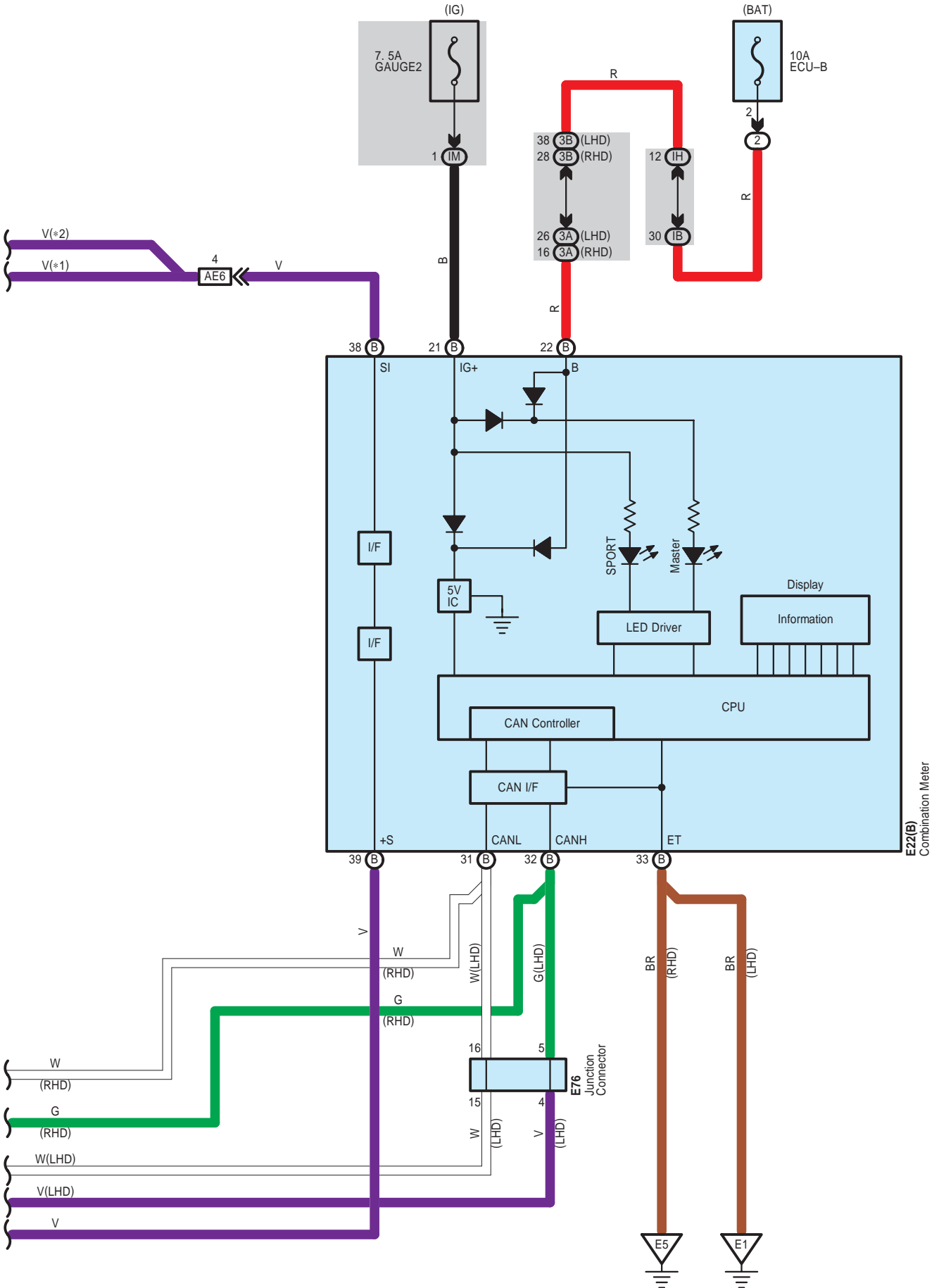

CVT , Shift Indicator

A 6
Black

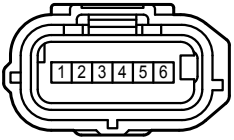

A 12
Black

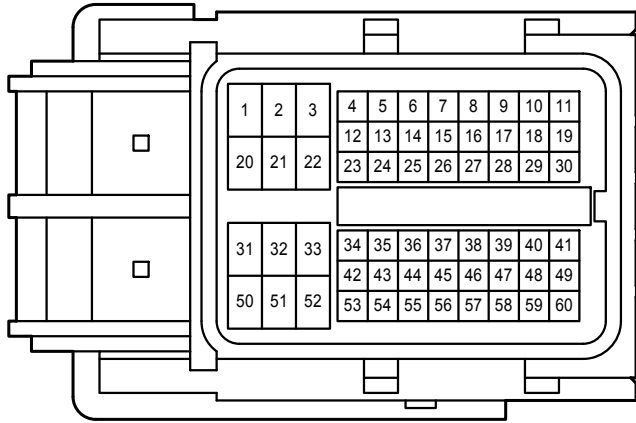

A 27
Black

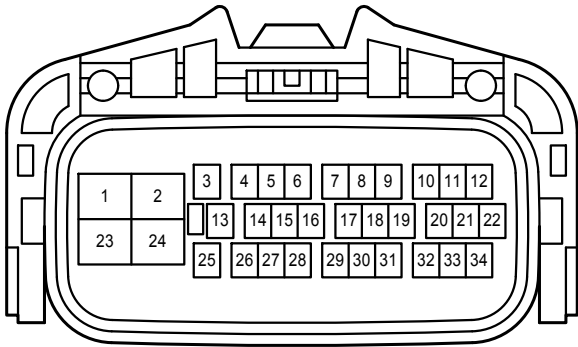

A 51
Gray

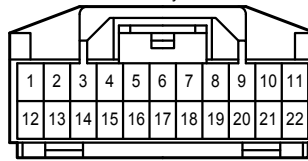

A 66
White

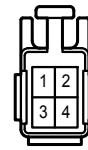

A 67
Black

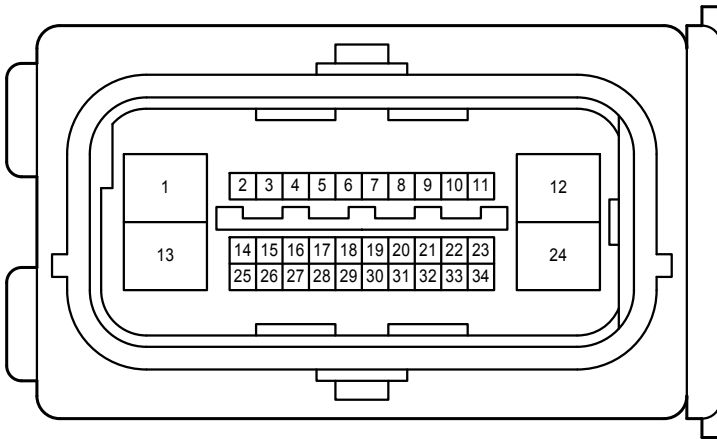

A 71
White

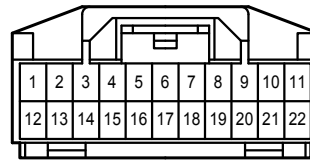

A 72
Gray

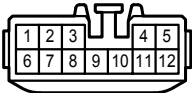

A 80
Gray

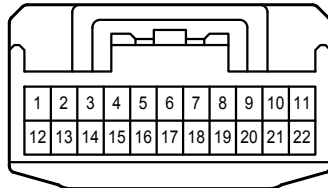

B 1
Black

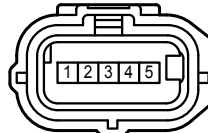

B 3
Black

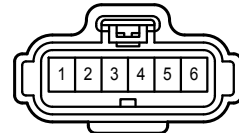

CVT , Shift Indicator

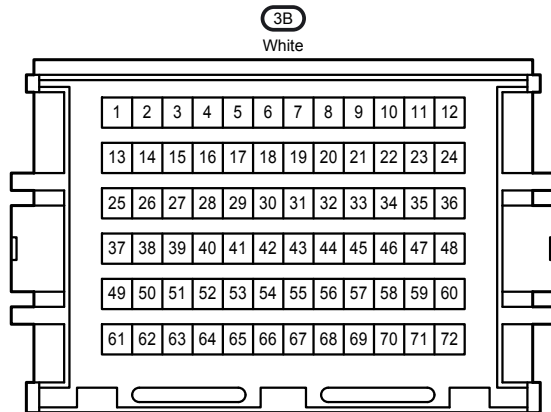
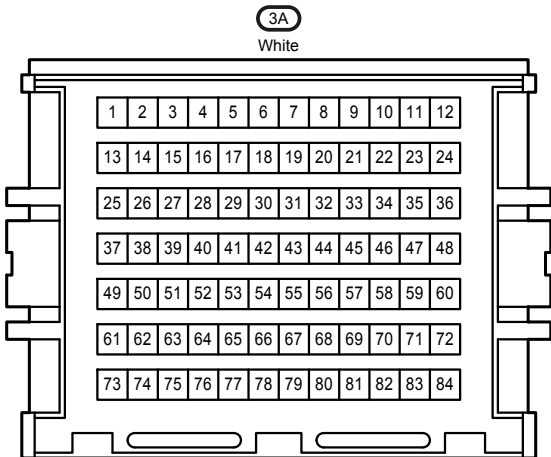
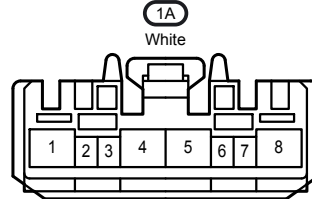
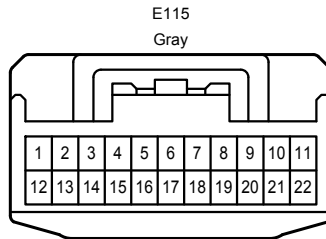
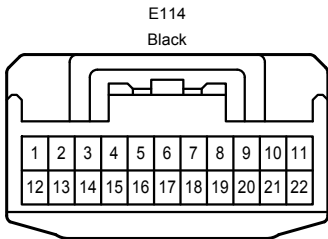
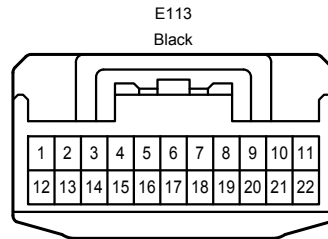
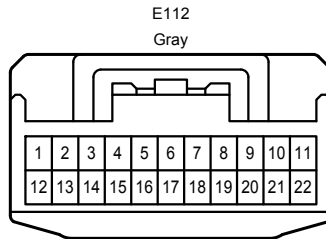
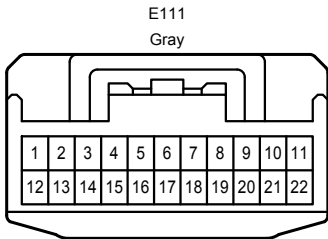
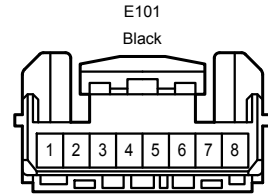
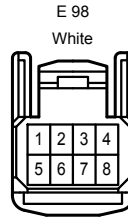
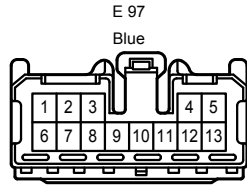
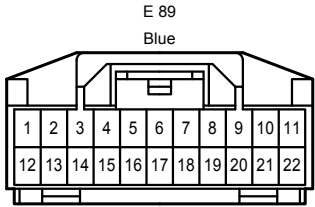
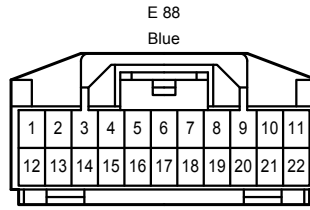
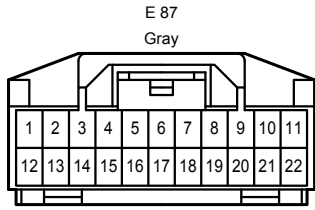
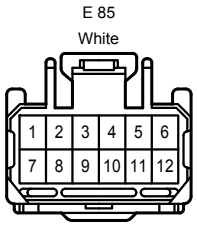

4A
White

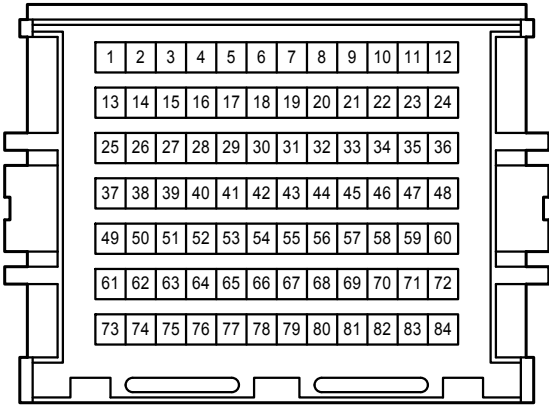

4B
White

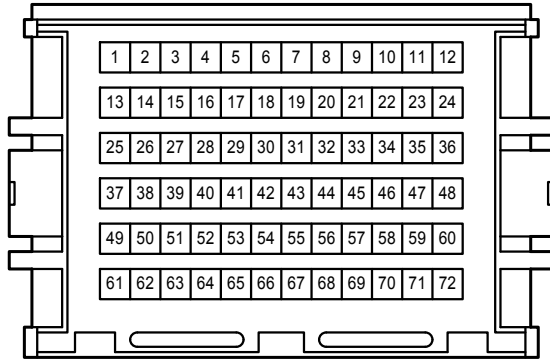

IB
White

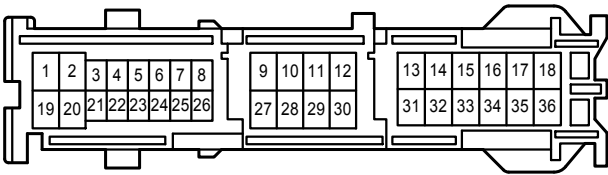

ID
White

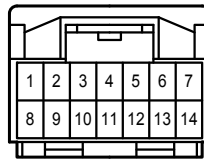

IE
White

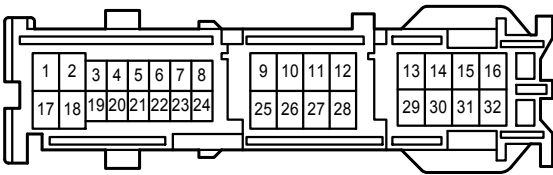

IH
White

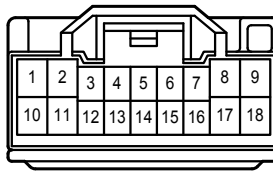

IM
White

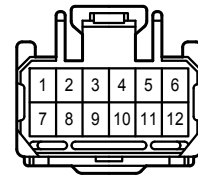

IS
White

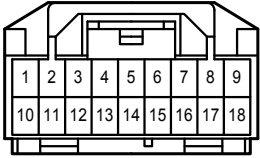

AE3
Black

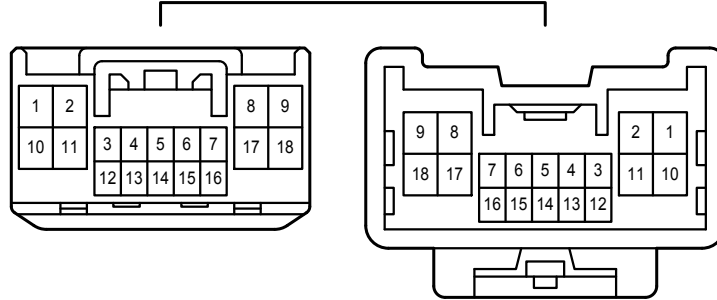

AE4
Gray

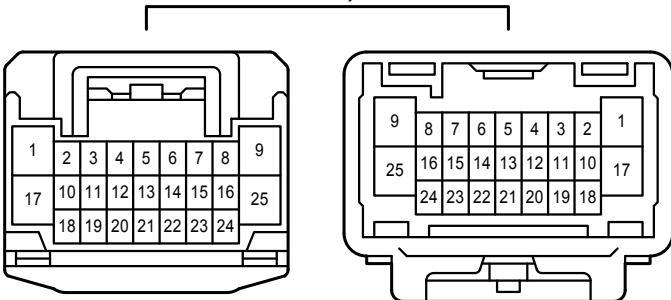

AE6
White

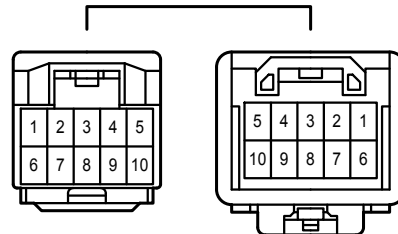

CVT , Shift Indicator

BA1
White

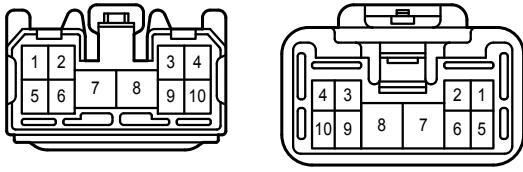

BA2
Gray

