

- * 1 : Gasoline
- * 2 : Australia
- * 3 : RHD Except Australia
- * 6 : Before Aug. 2008 Production Except Europe, Before Dec. 2008 Production Europe
- * 7 : From Aug. 2008 Production Except Europe, From Dec. 2008 Production Europe

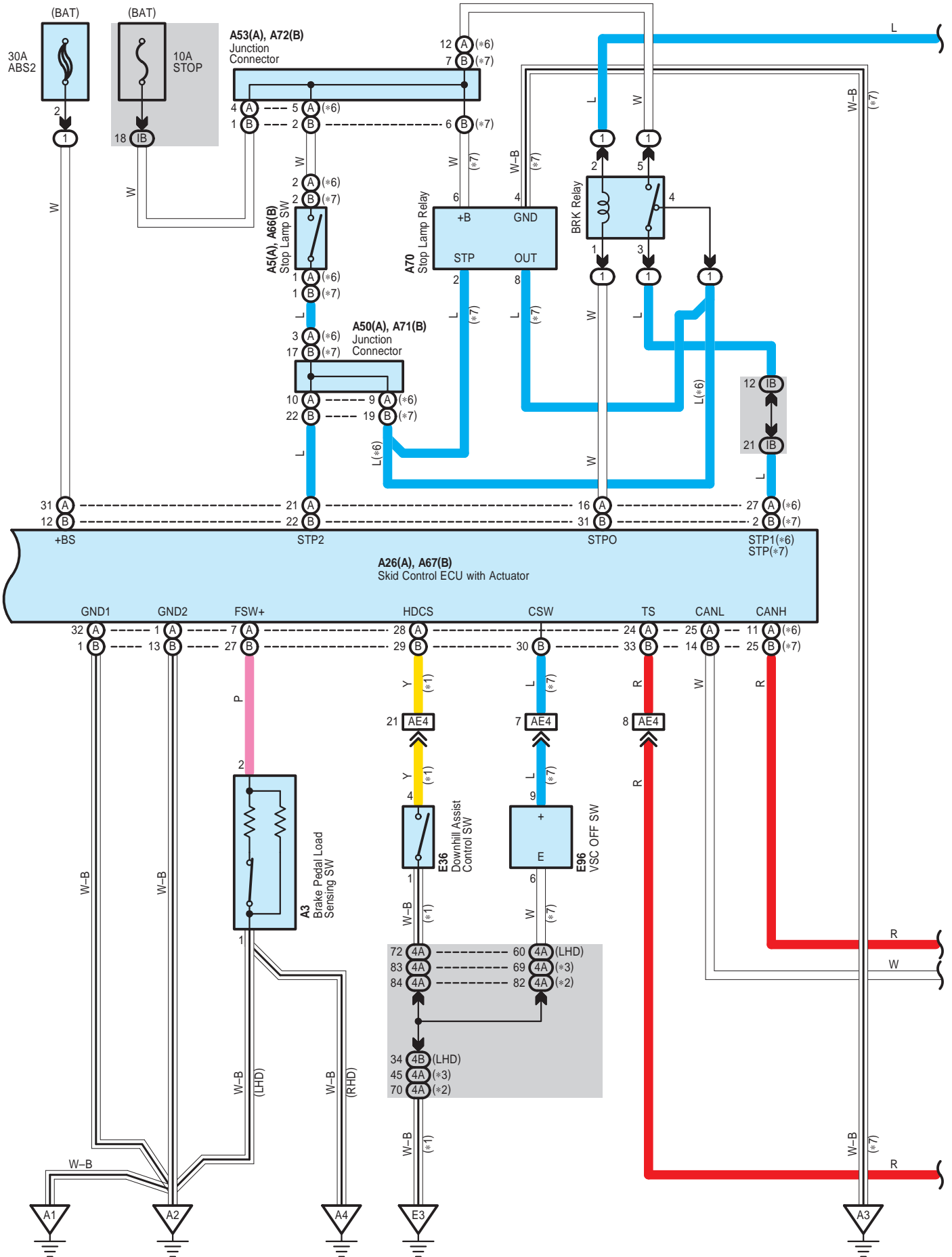

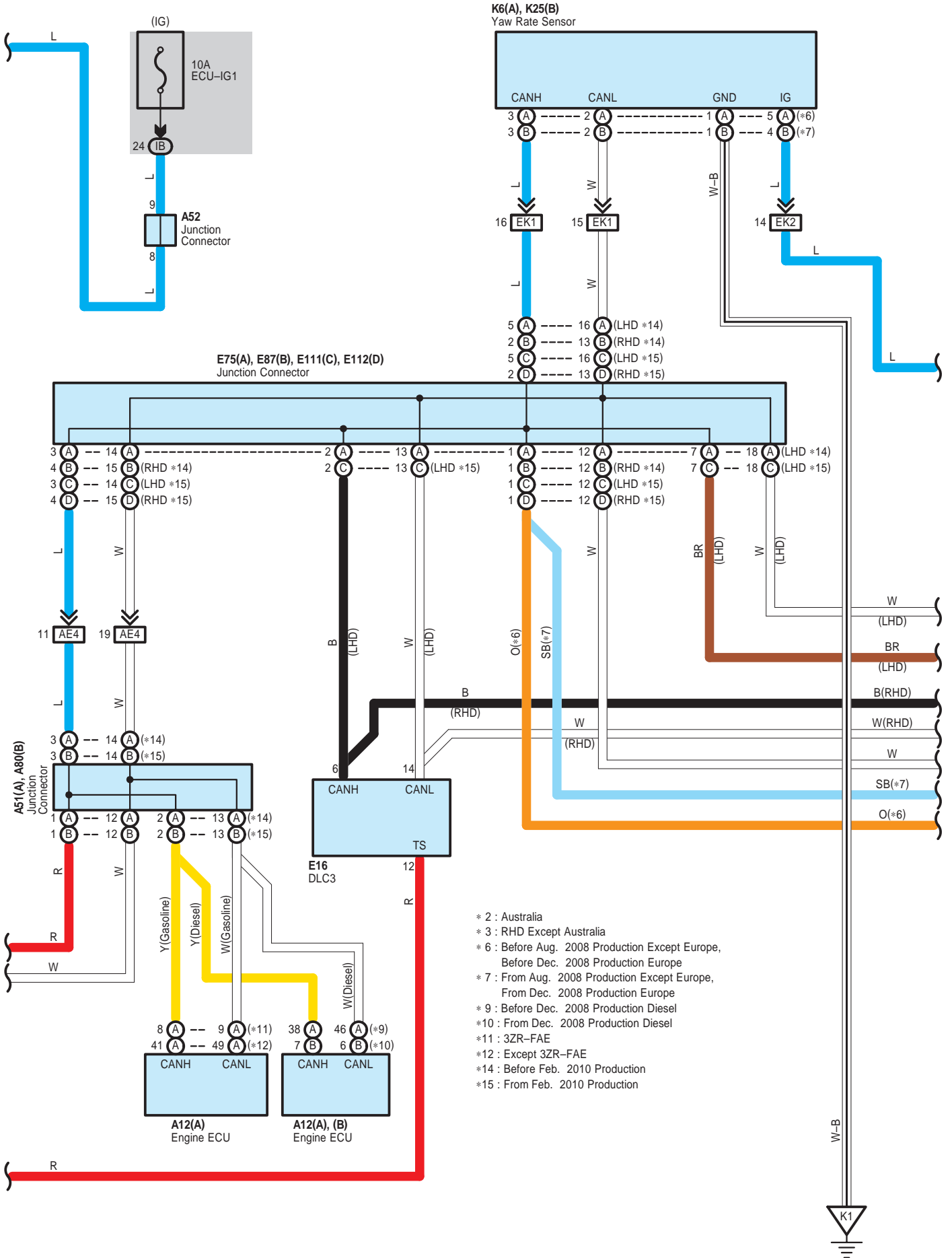

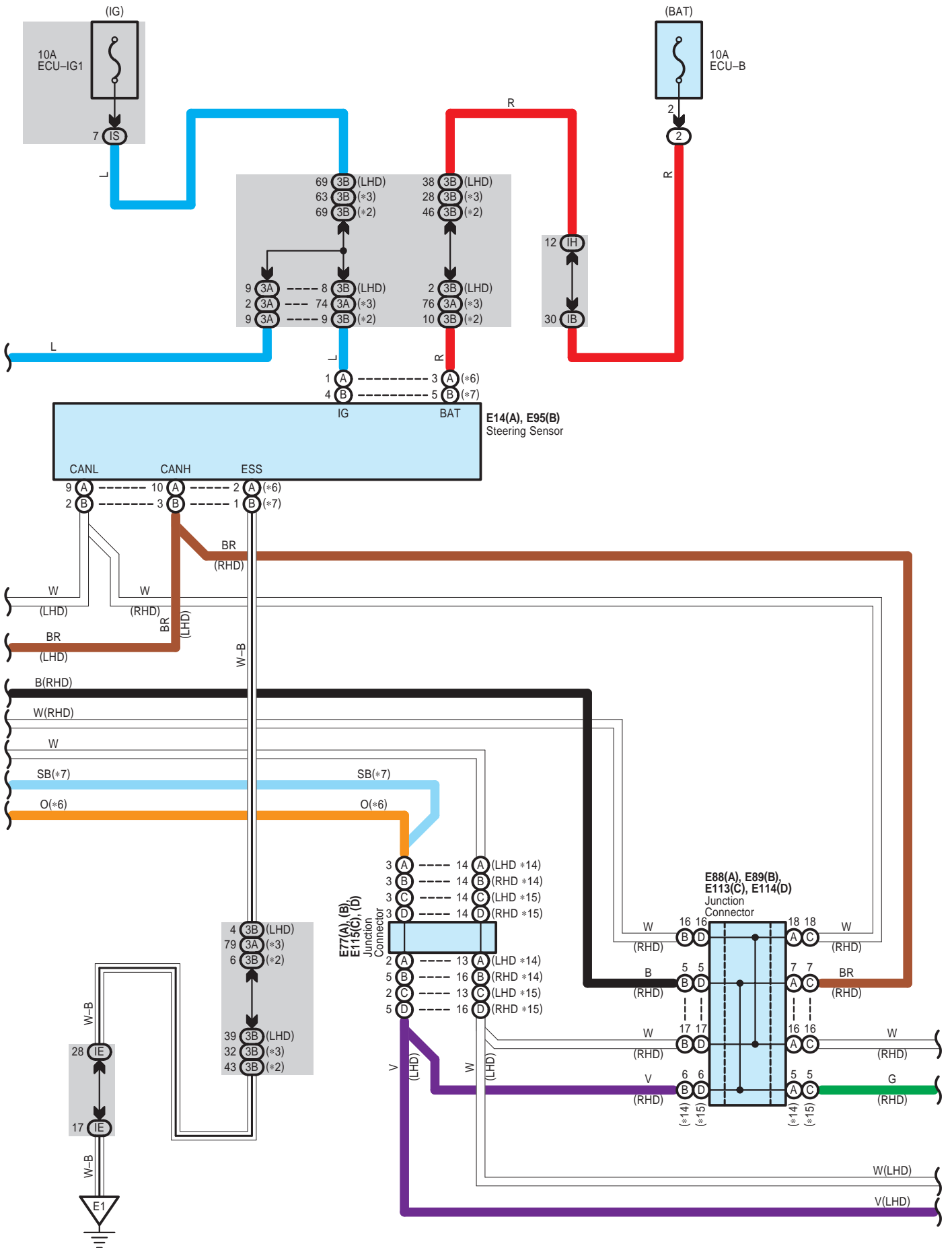

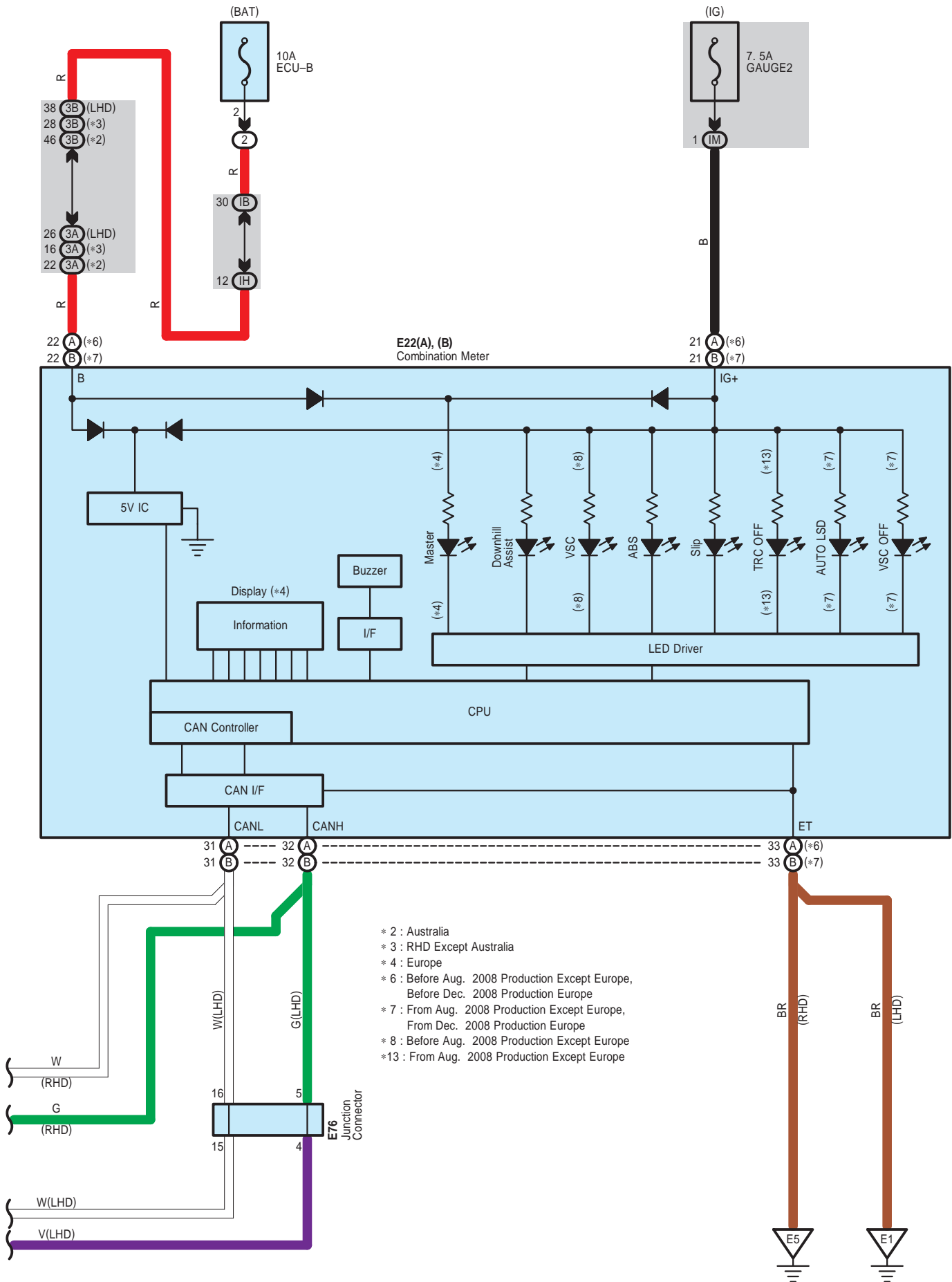

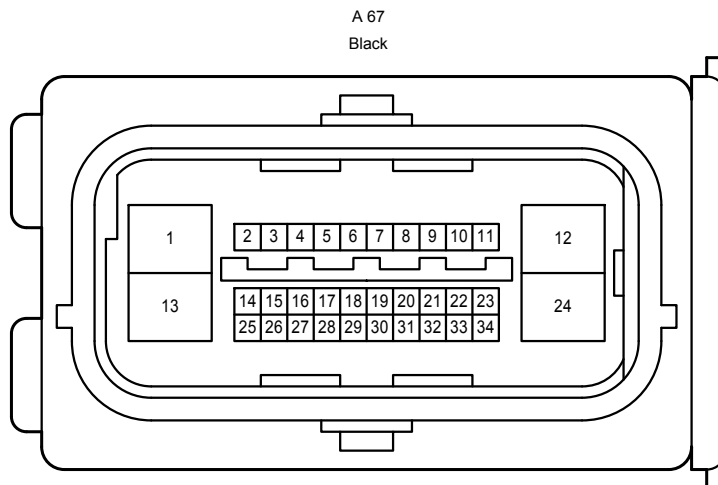
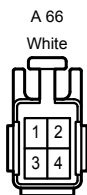
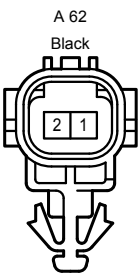
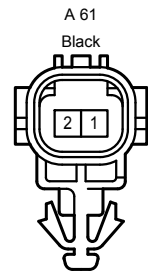
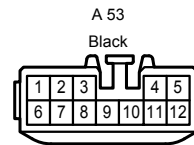
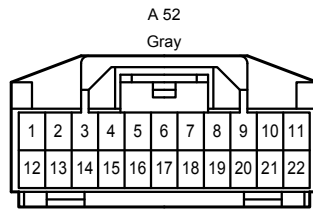
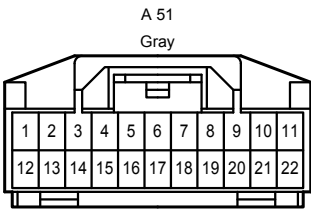
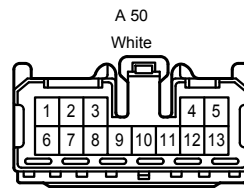
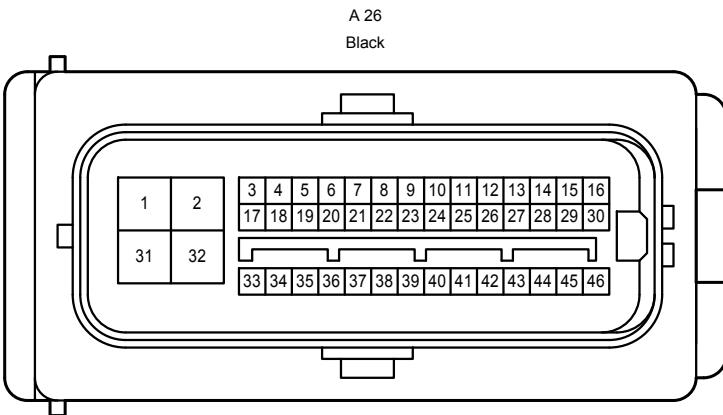
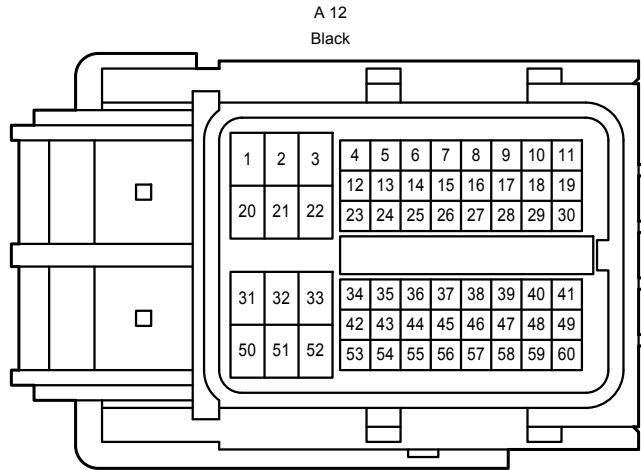
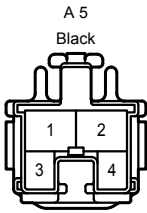
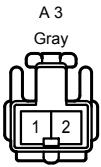

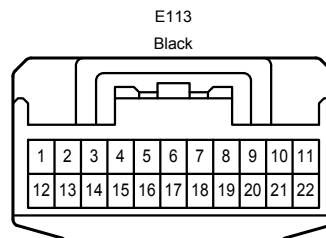
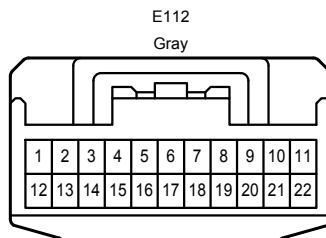
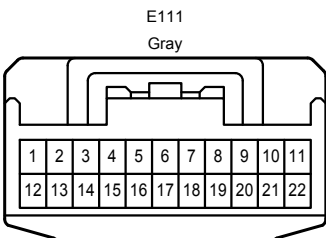
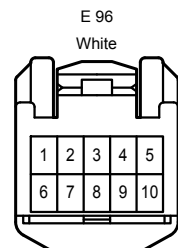
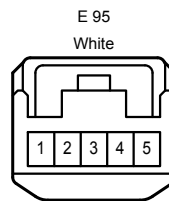
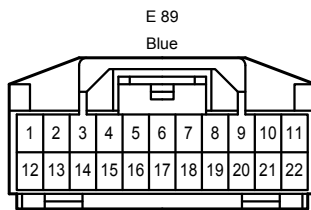
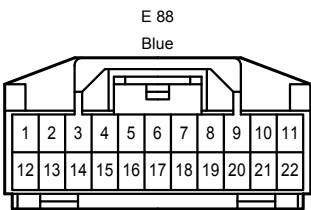
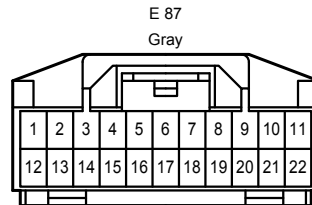
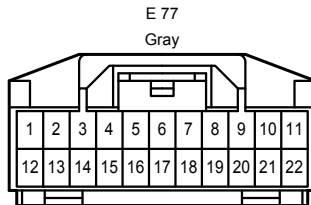
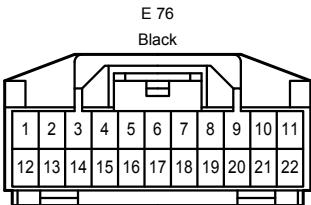
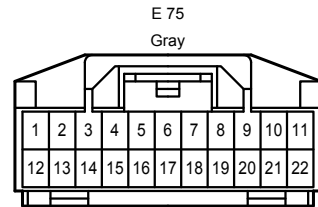
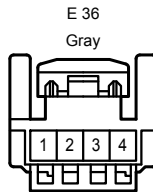
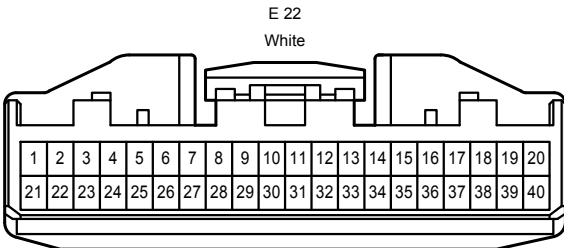
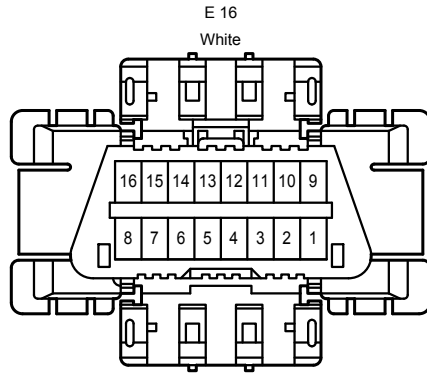
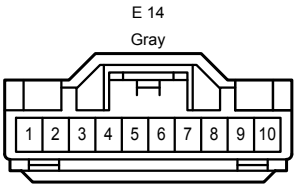
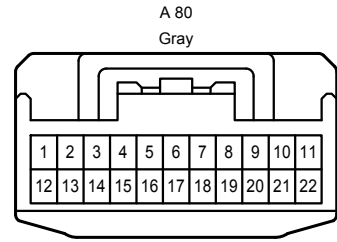
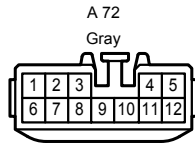
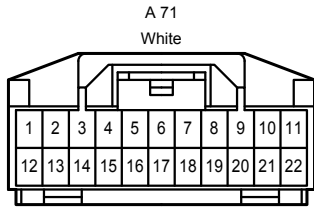
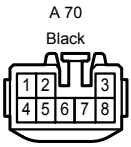

E114
Black

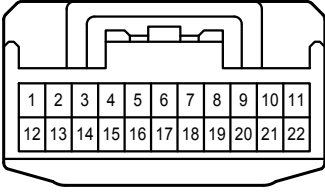

E115
Gray

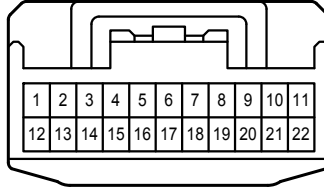

K 6
Black

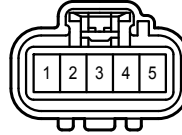

K 25
Black

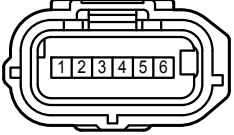

K 28
White



K 29
White



W 1
Black



X 1
Black

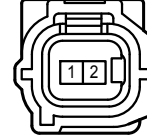

3A
White

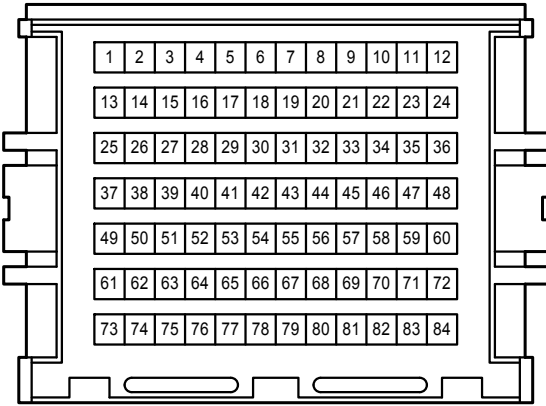

3B
White

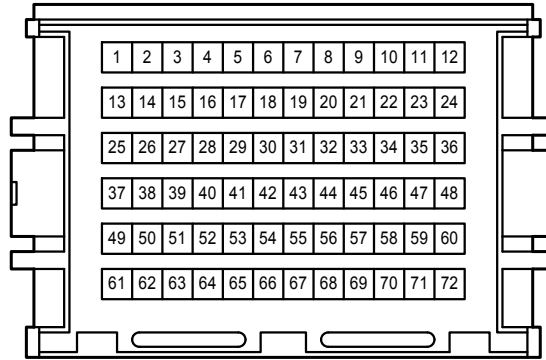

4A
White

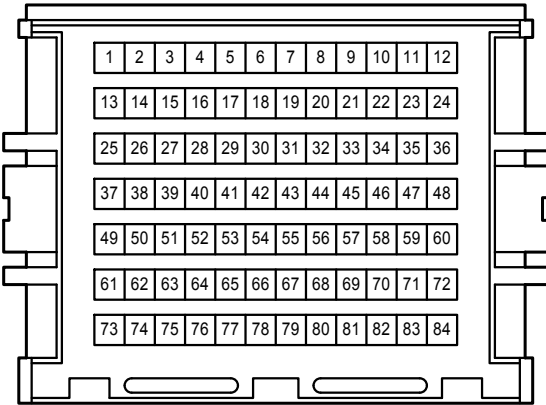

4B
White

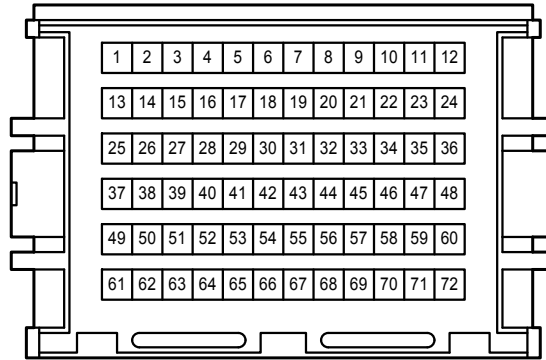

1B
White

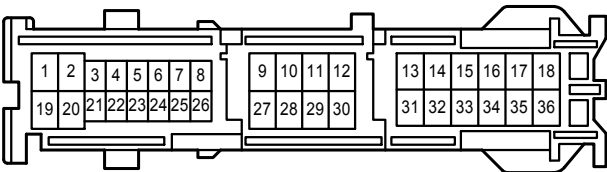

1E
White

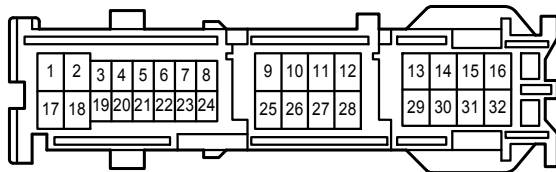

IH
White

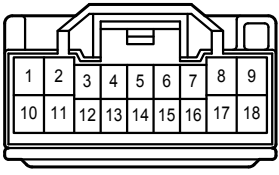

IM
White

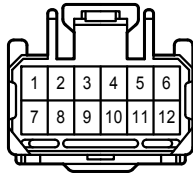

IS
White

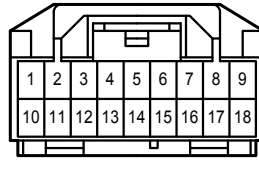

AE4
Gray

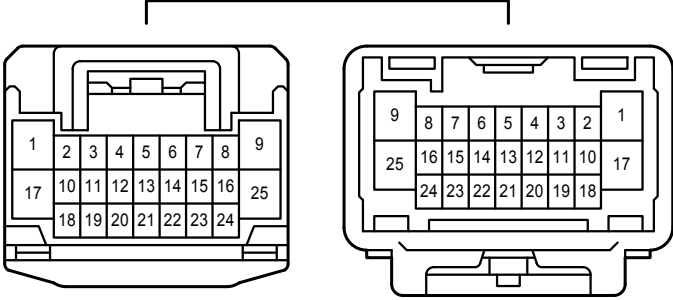

AK1
White

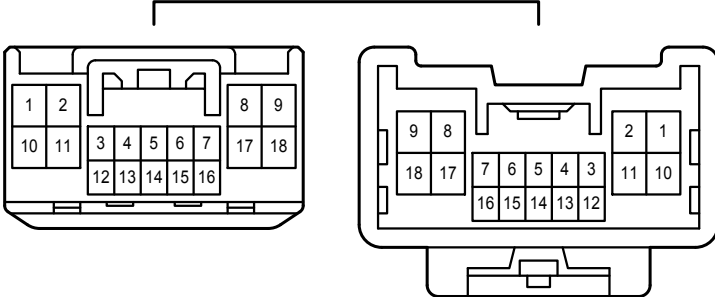

EK1
White

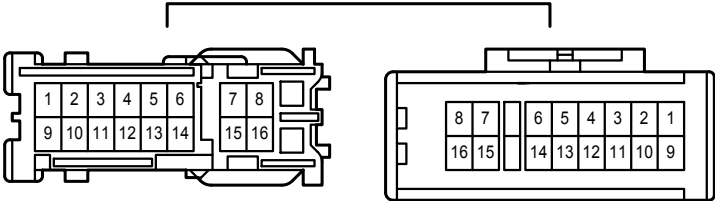

EK2
White

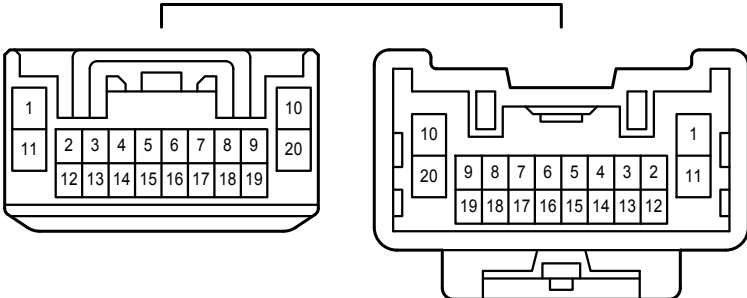

WK1
White

