

Engine Immobiliser System <w/o Entry & Start System>

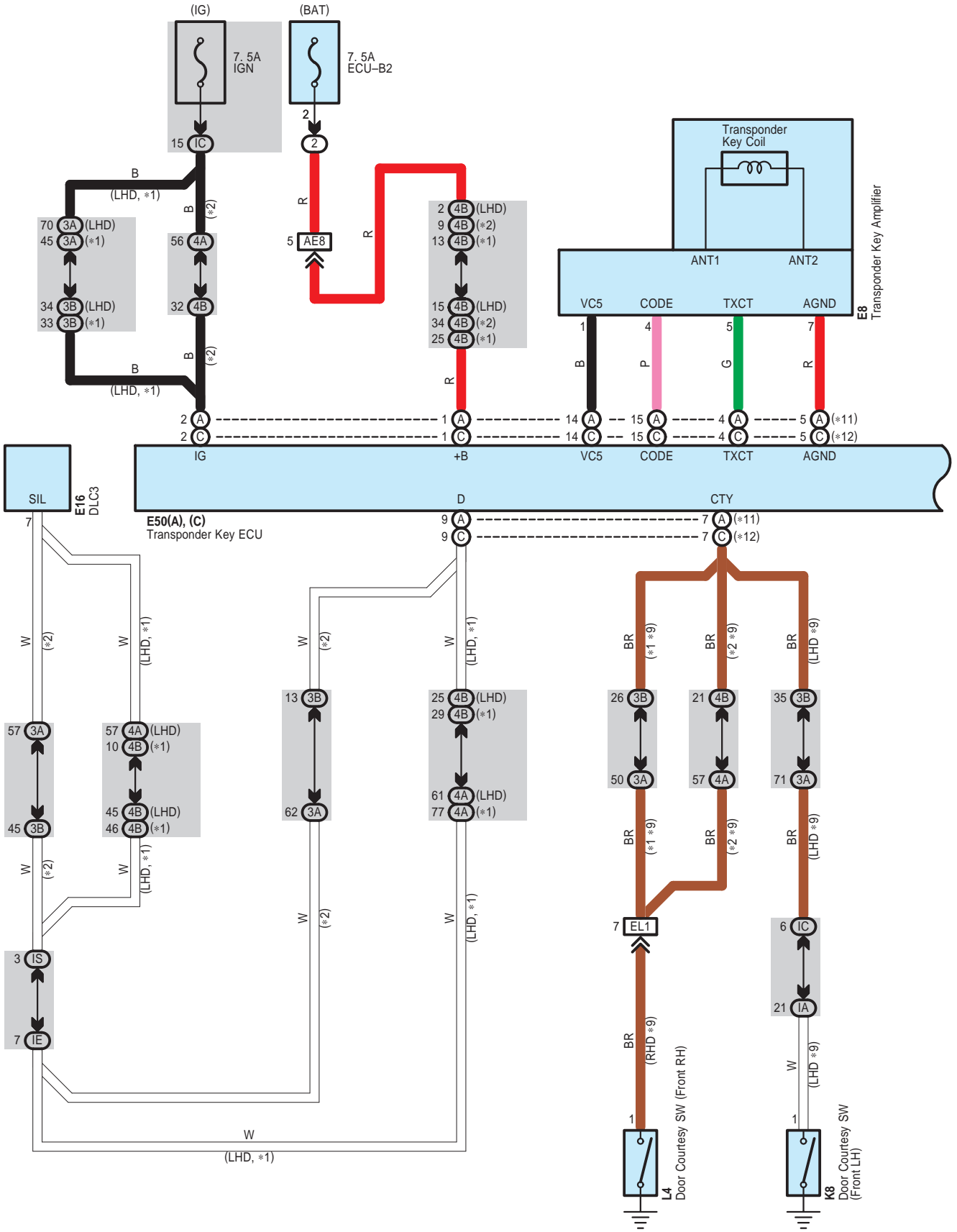

Engine Immobiliser System <w/o Entry & Start System>

- * 1 : Australia
- * 2 : RHD Except Australia
- * 3 : Automatic A/C
- * 4 : Manual A/C
- * 5 : Gasoline
- * 6 : Diesel
- * 7 : Before Dec. 2008 Production Europe
- * 8 : From Dec. 2008 Production Europe
- * 9 : Before Aug. 2009 Production
- * 10 : From Aug. 2009 Production
- * 11 : Before Aug. 2010 Production
- * 12 : From Aug. 2010 Production

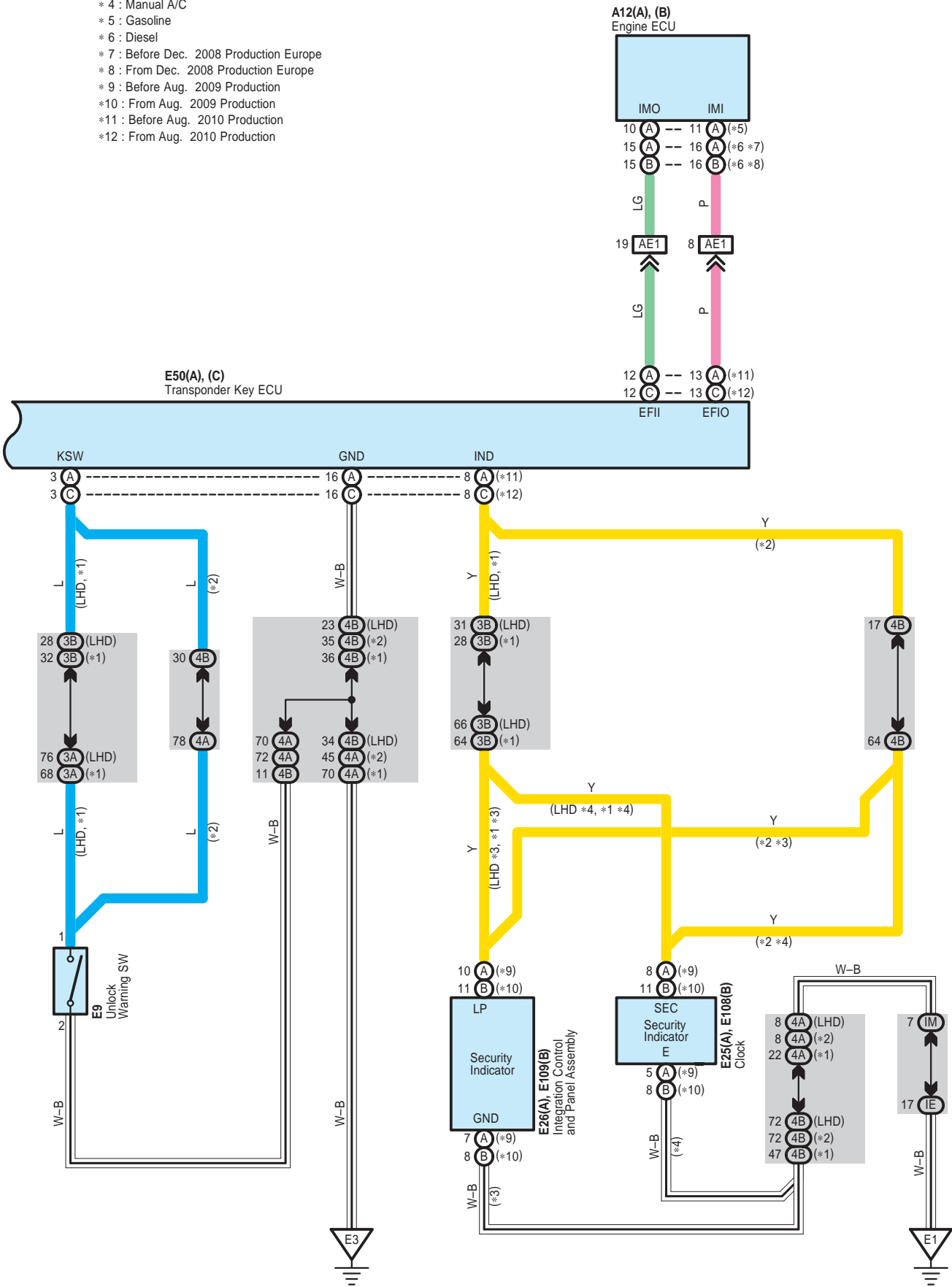

Engine Immobiliser System <w/o Entry & Start System>

A 12
Black

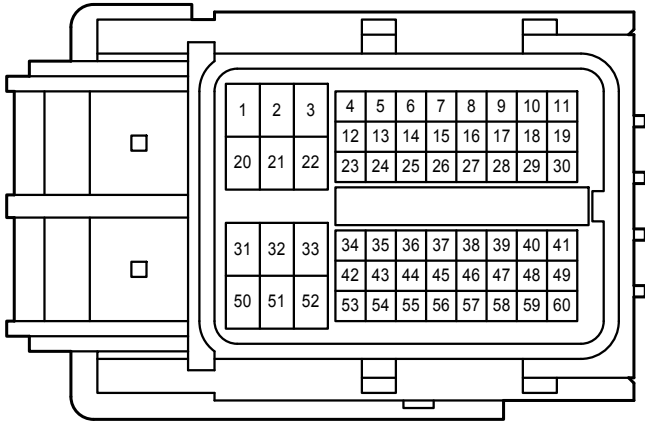

E 8
Black

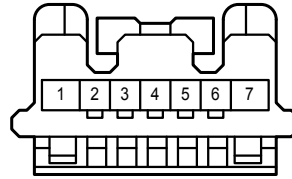

E 9
White



E 16
White

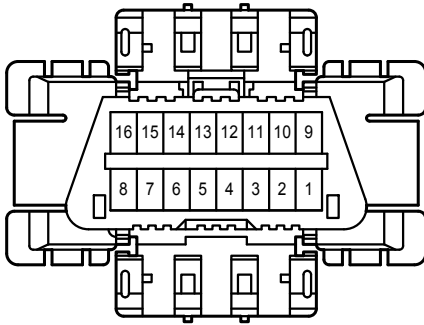

E 25
White

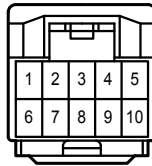

E 26
White

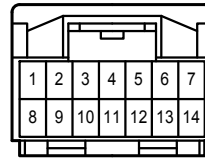

E 50
White

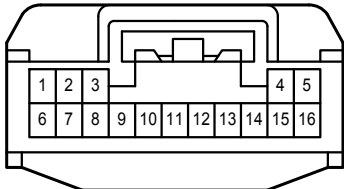

(Before Aug. 2010 Production)

E 50
Black

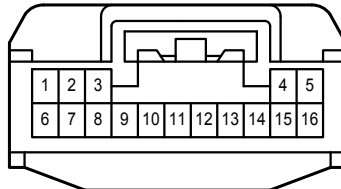

(From Aug. 2010 Production)

E108
Black

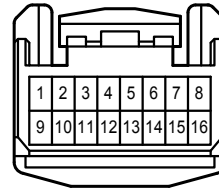

E109
Black

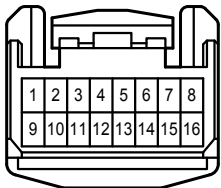

K 8
White



L 4
White



3A
White

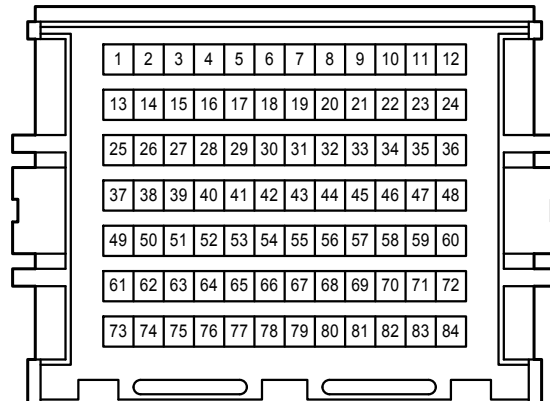

Engine Immobiliser System <w/o Entry & Start System>

3B
White

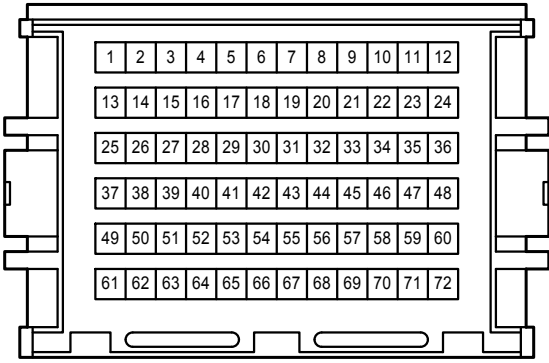

4A
White

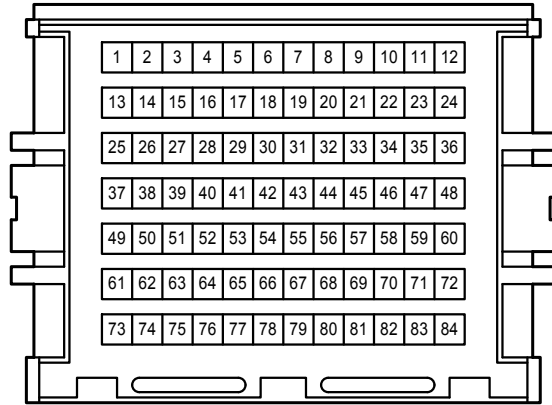

4B
White

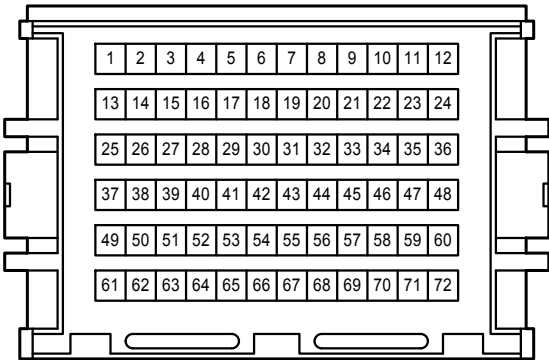

1A
White

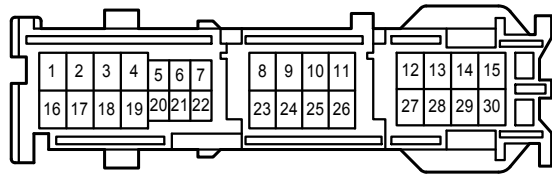

1C
White

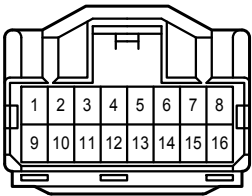

1E
White

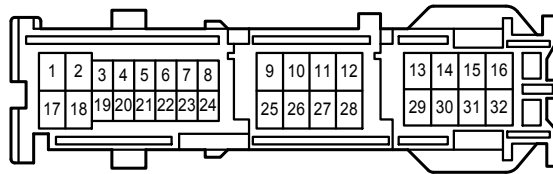

1M
White

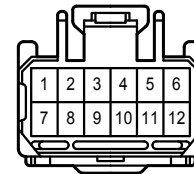

1S
White

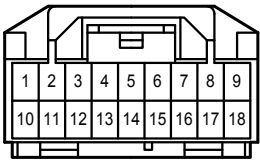

AE1
White

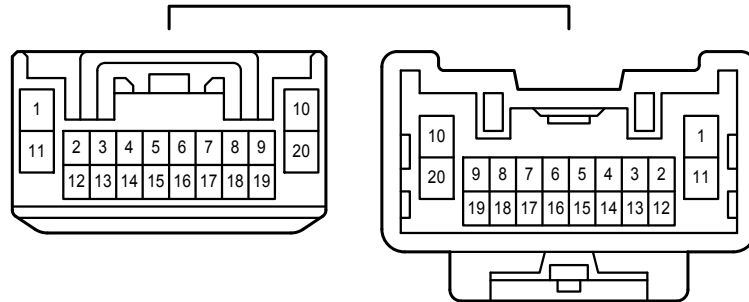

Engine Immobiliser System <w/o Entry & Start System>

AE8
White

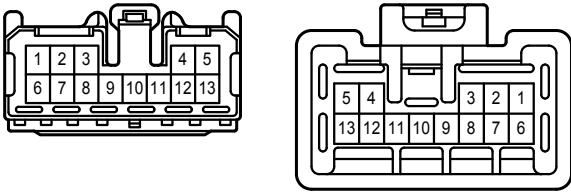

EL1
White

