

Cruise Control <2GR-FE>

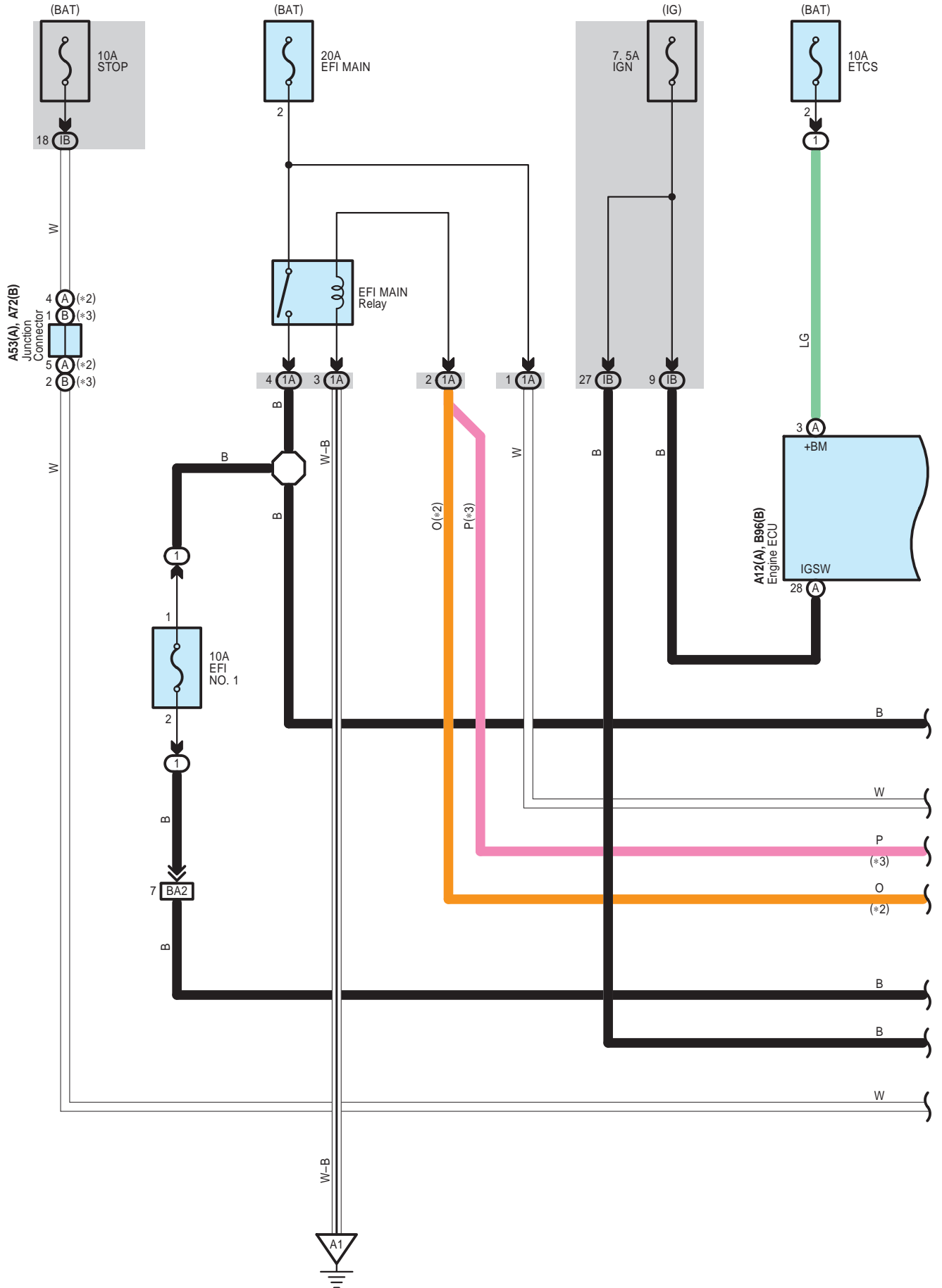

**Cruise Control <2GR-FE>**

- \* 1 : Shielded
- \* 2 : Before Aug. 2008 Production
- \* 3 : From Aug. 2008 Production

**B3**  
Throttle Body Assembly

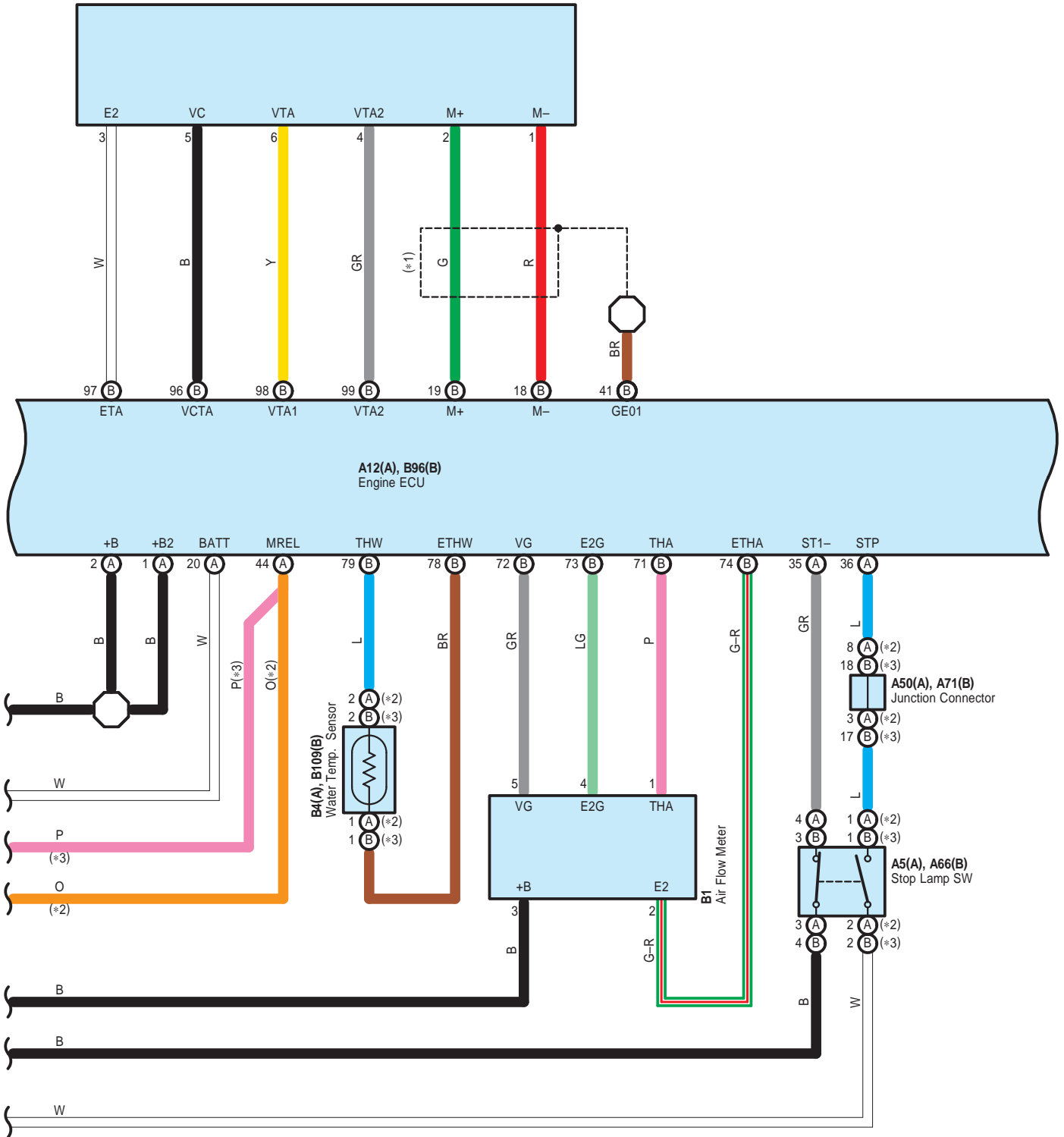

Cruise Control <2GR-FE>

\* 2 : Before Aug. 2008 Production  
 \* 3 : From Aug. 2008 Production

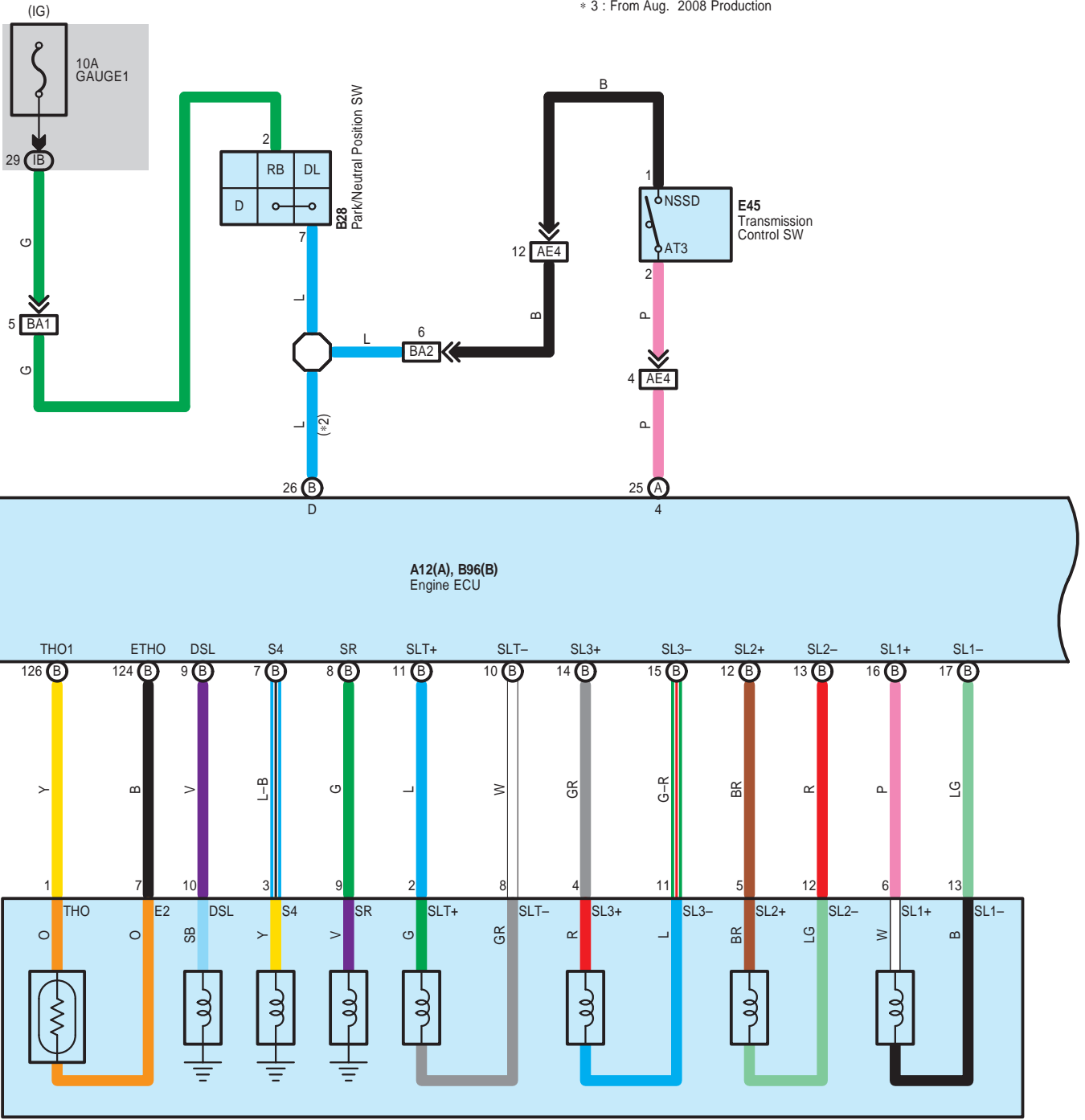

B66  
ECT Solenoid

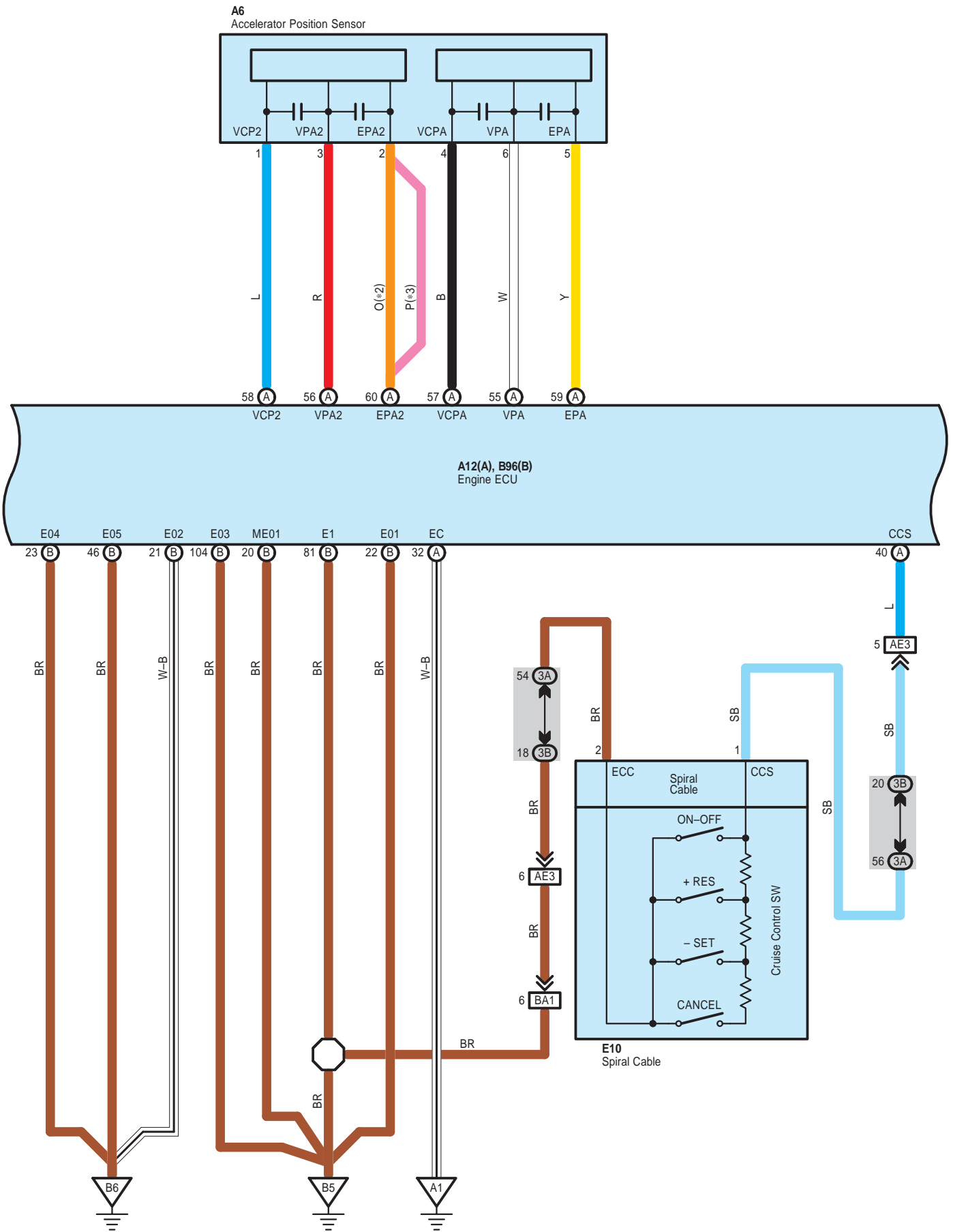

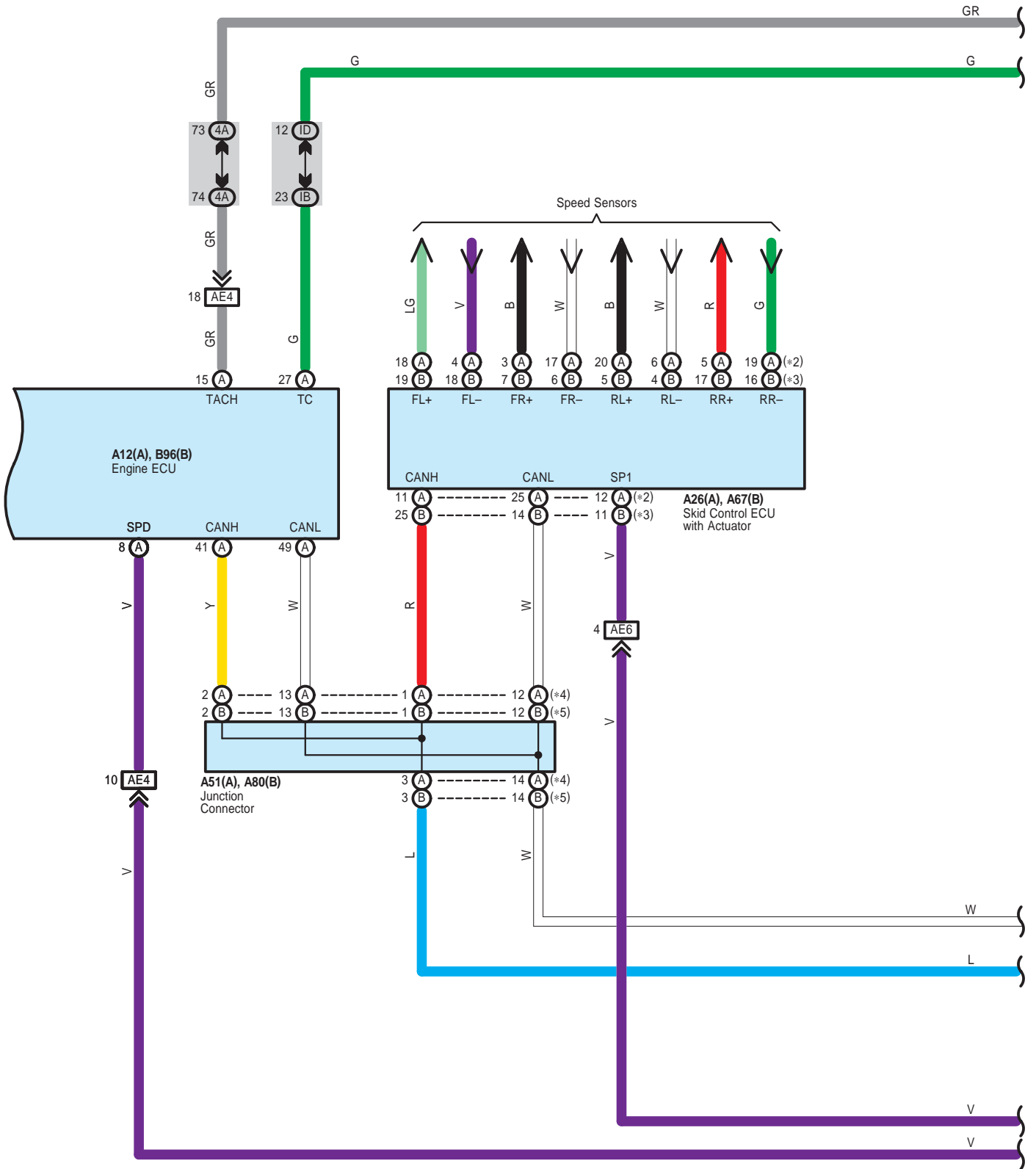

# Cruise Control <2GR-FE>

- \* 2 : Before Aug. 2008 Production
- \* 3 : From Aug. 2008 Production
- \* 4 : Before Feb. 2010 Production
- \* 5 : From Feb. 2010 Production

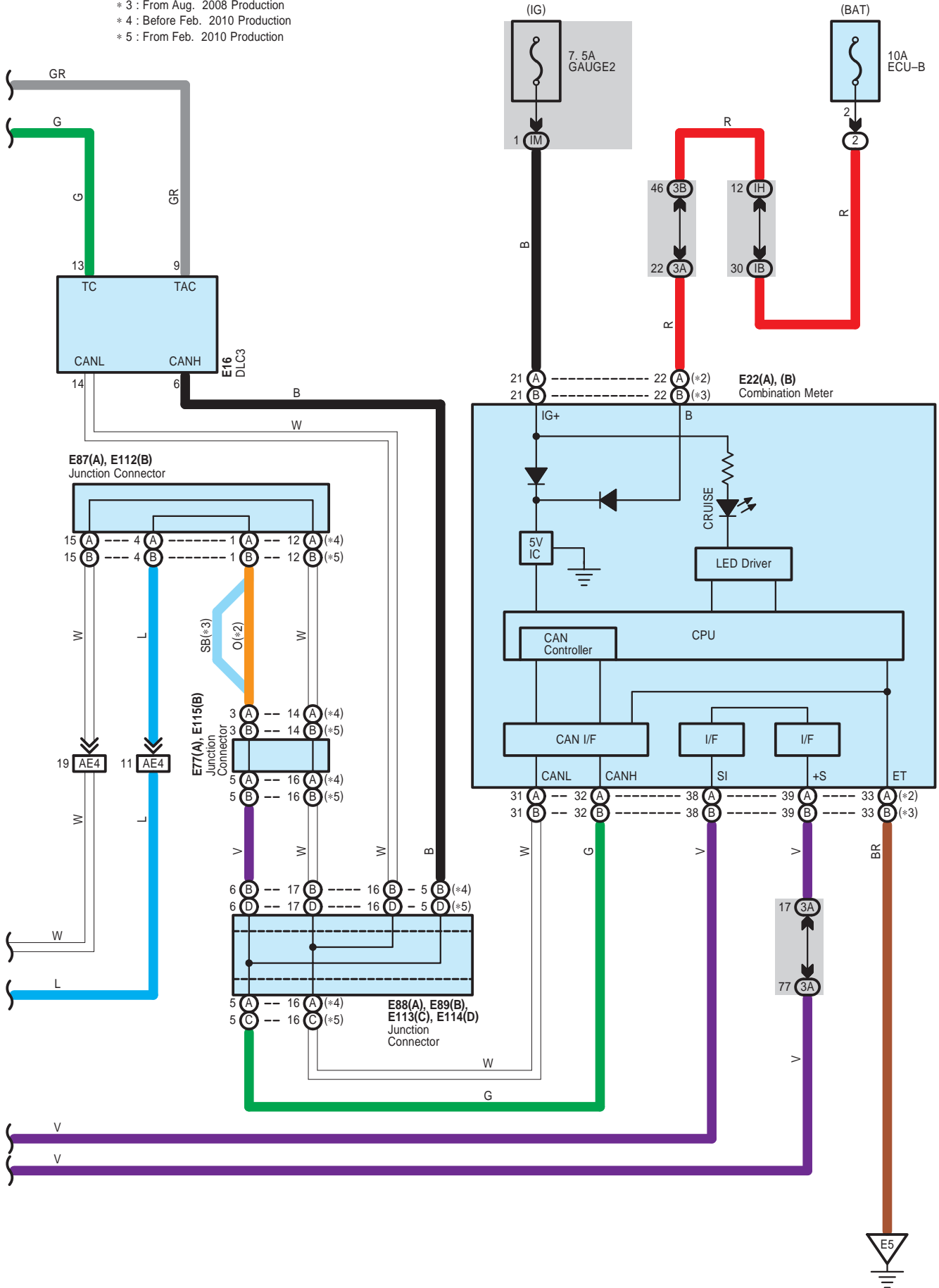

Cruise Control <2GR-FE>

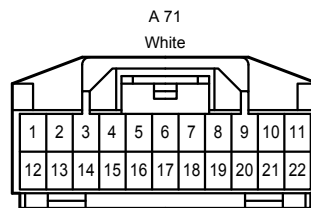
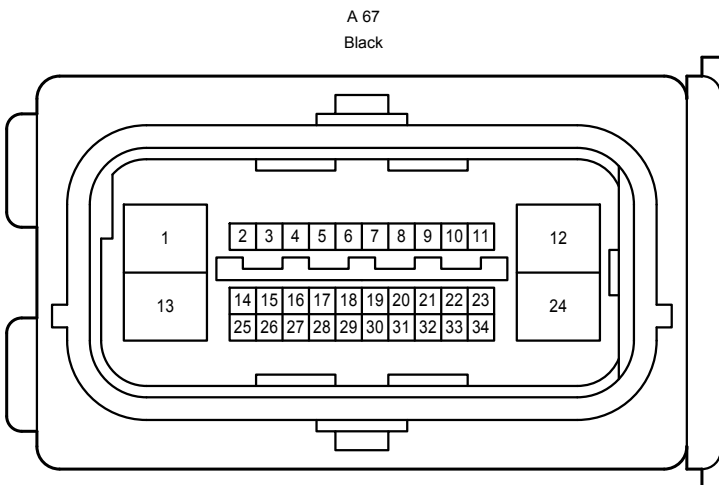
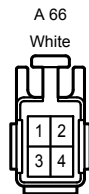
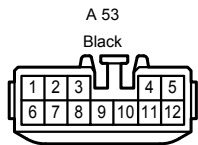
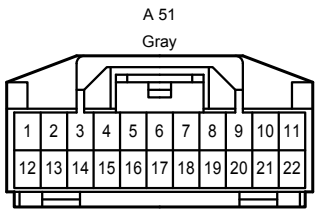
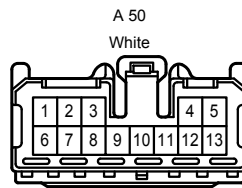
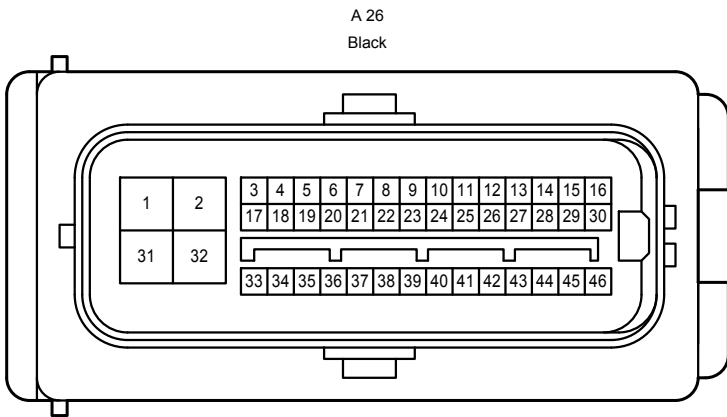
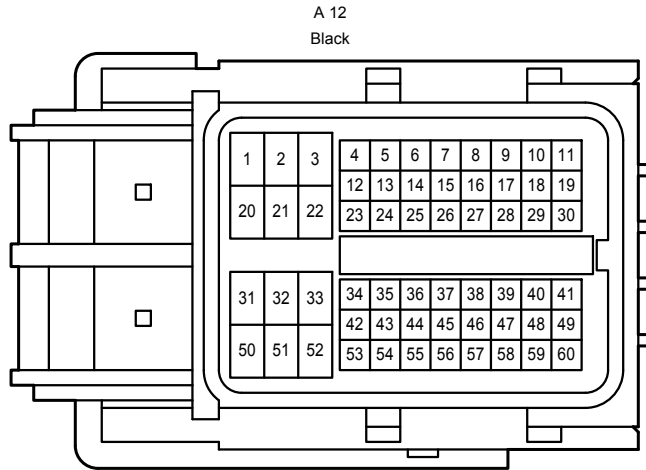
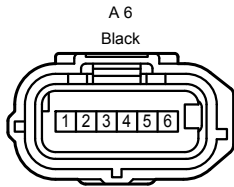
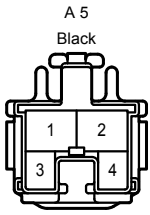

Cruise Control <2GR-FE>

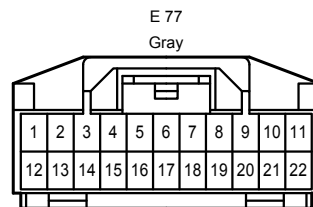
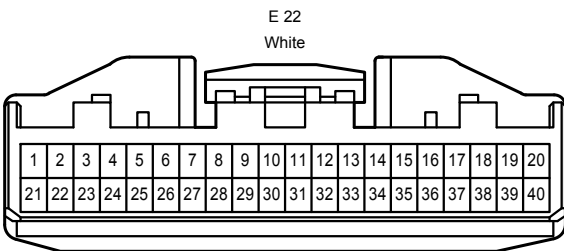
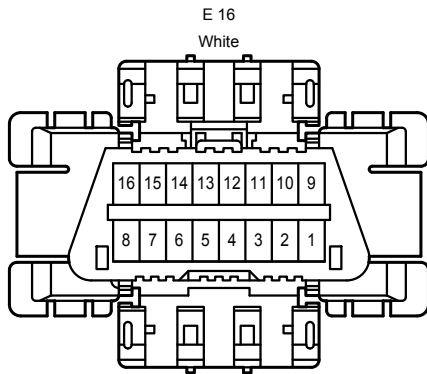
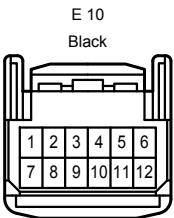
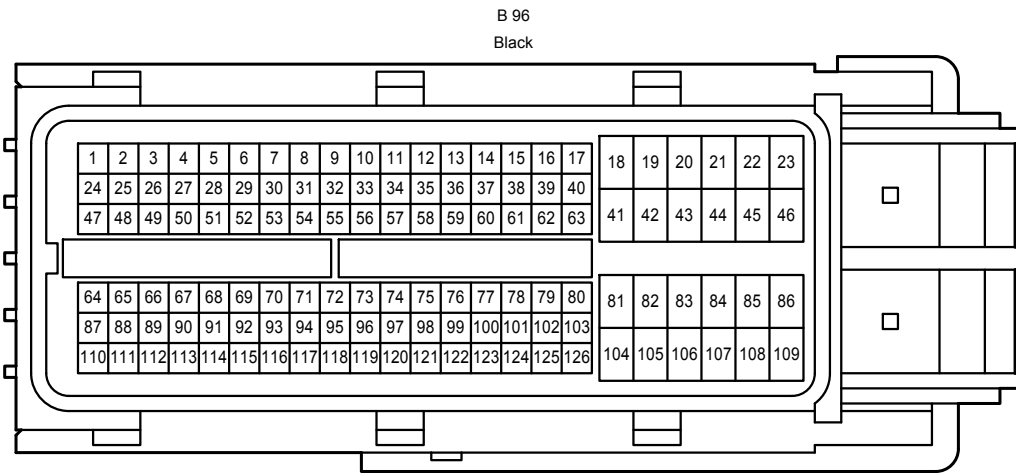
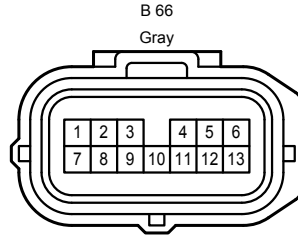
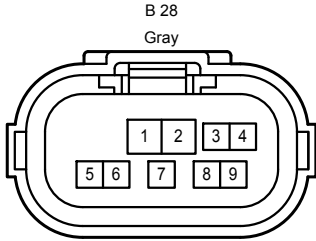
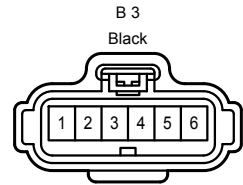
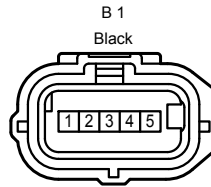
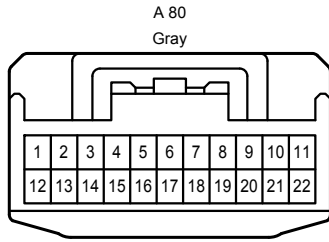
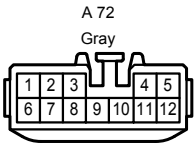



Cruise Control <2GR-FE>

E 87  
Gray

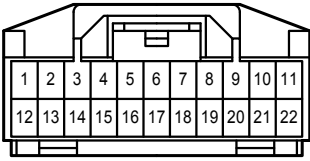

E 88  
Blue

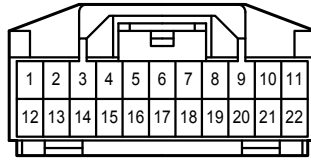

E 89  
Blue

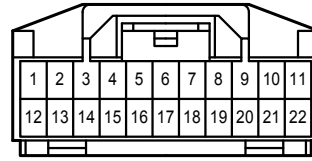

E112  
Gray

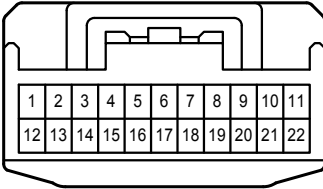

E113  
Black

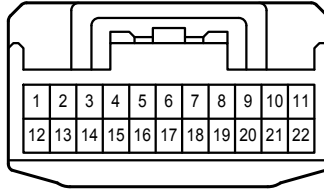

E114  
Black

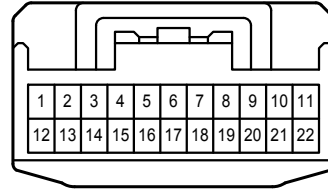

E115  
Gray

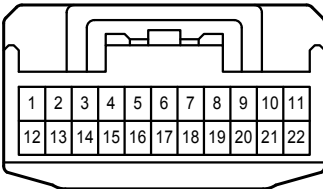

1A  
White

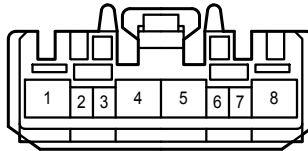

3A  
White

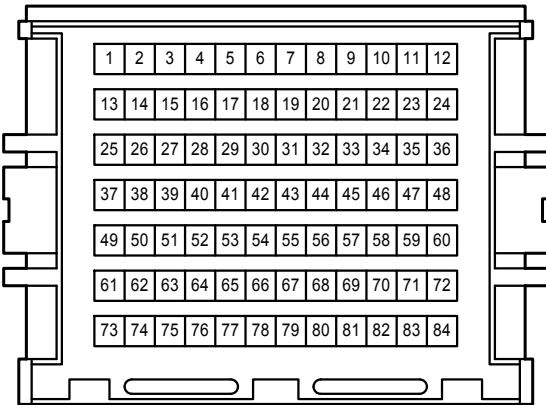

3B  
White

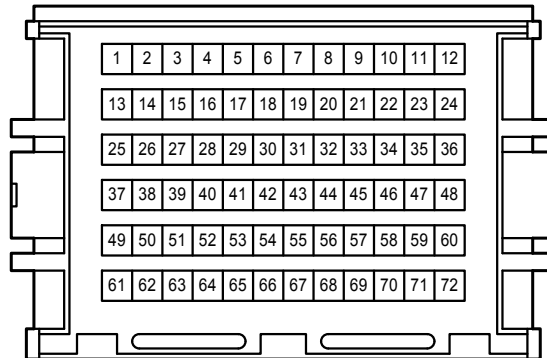

4A  
White

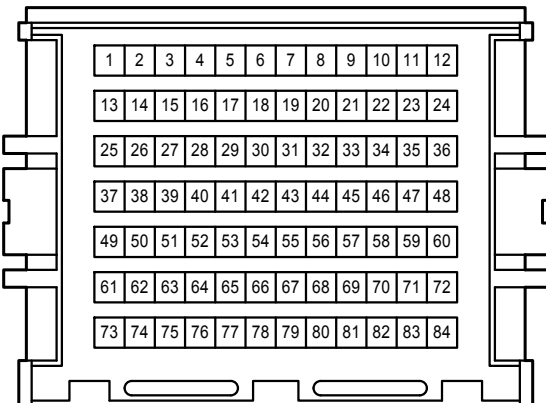

1B  
White

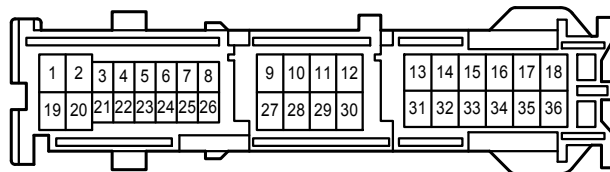

Cruise Control <2GR-FE>

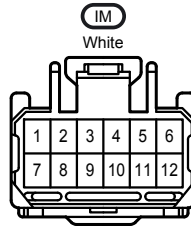
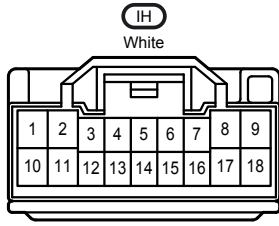
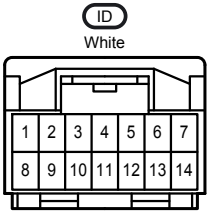

AE3  
Black

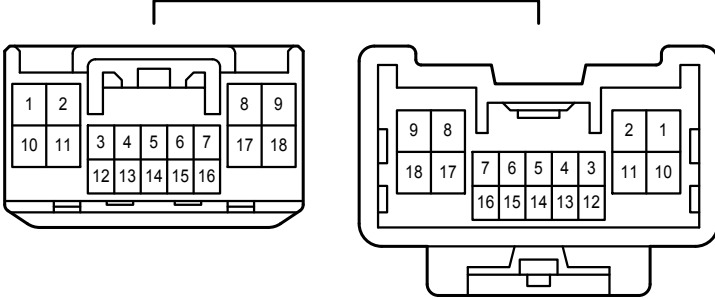

AE4  
Gray

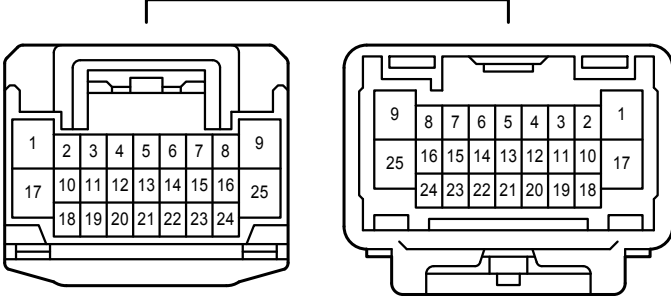

AE6  
White

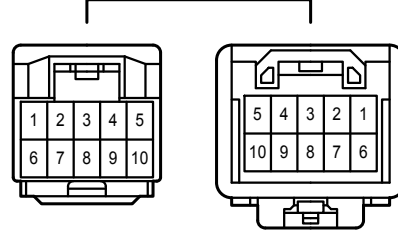

BA1  
White

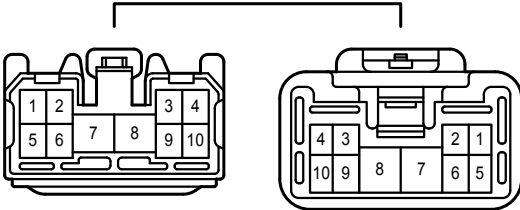

BA2  
Gray

