

Cruise Control <3ZR-FAE>

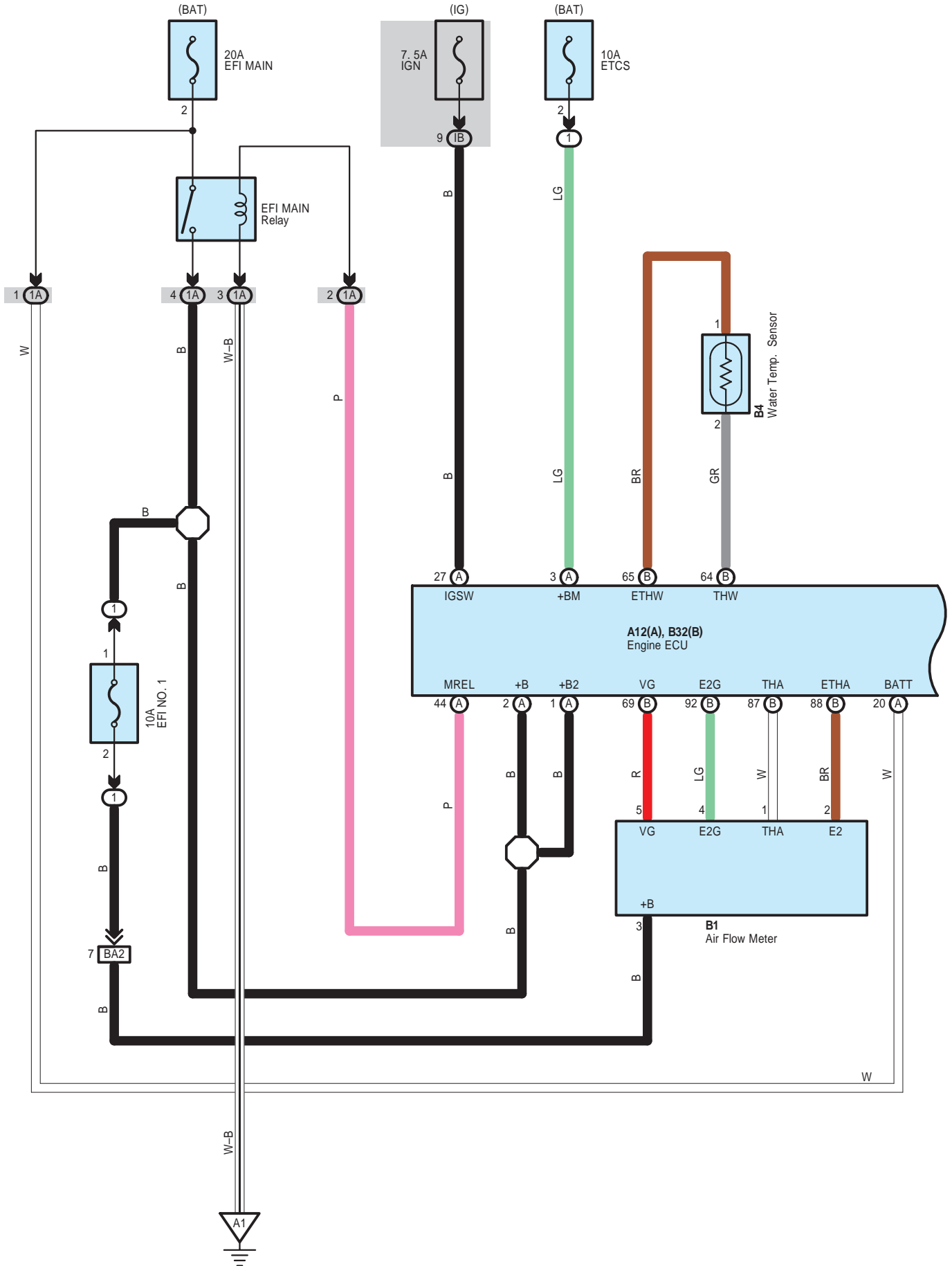

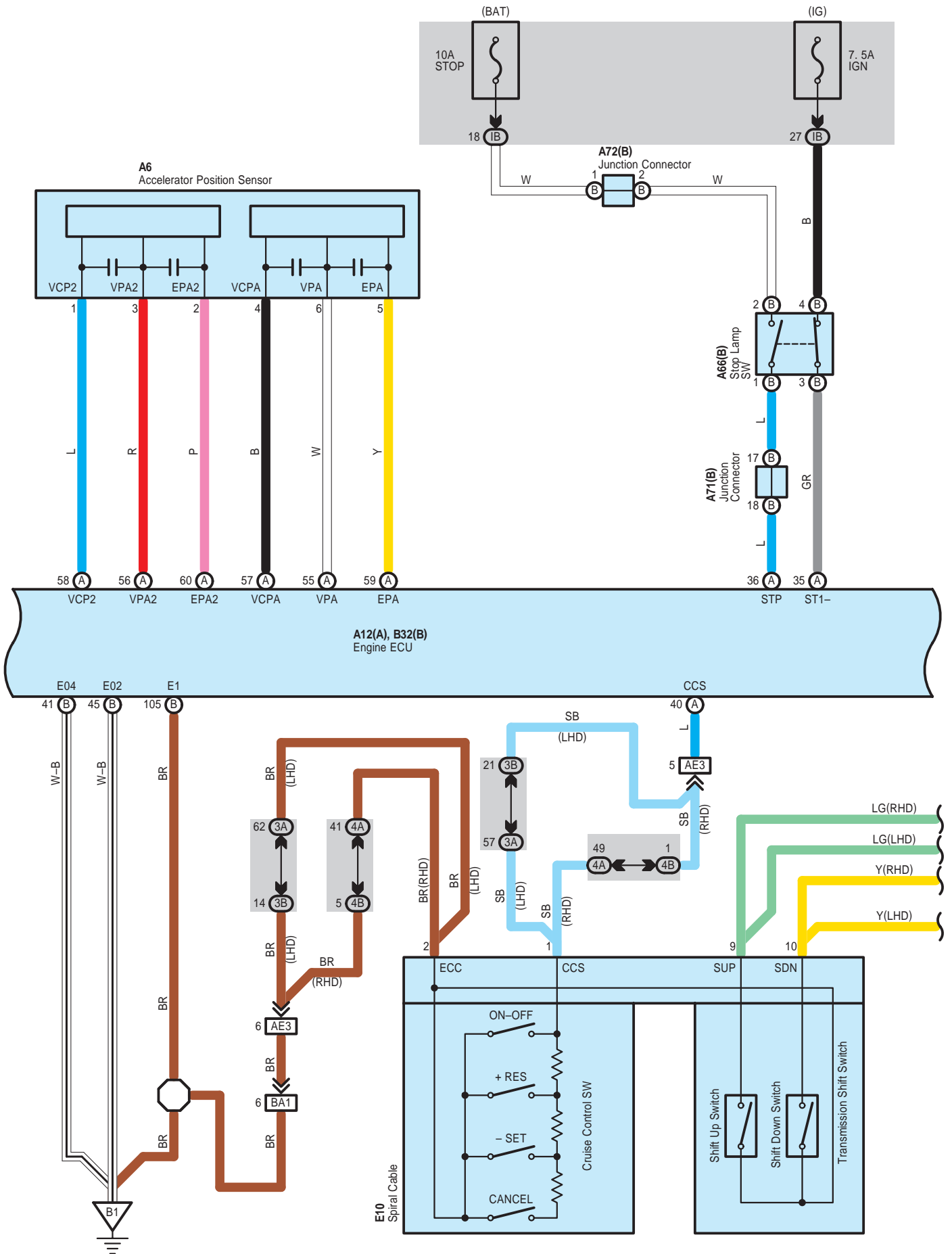

Cruise Control <3ZR-FAE>

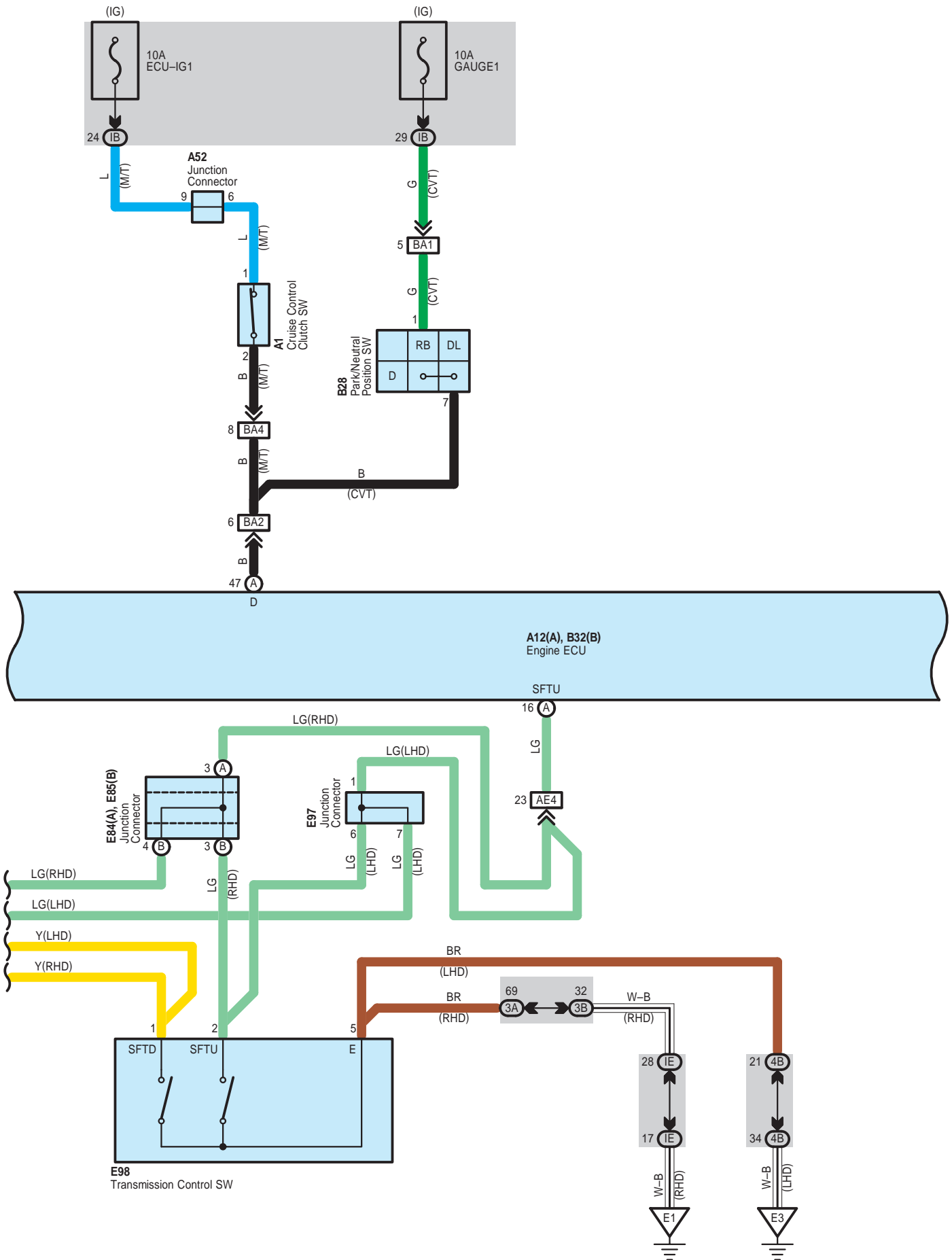

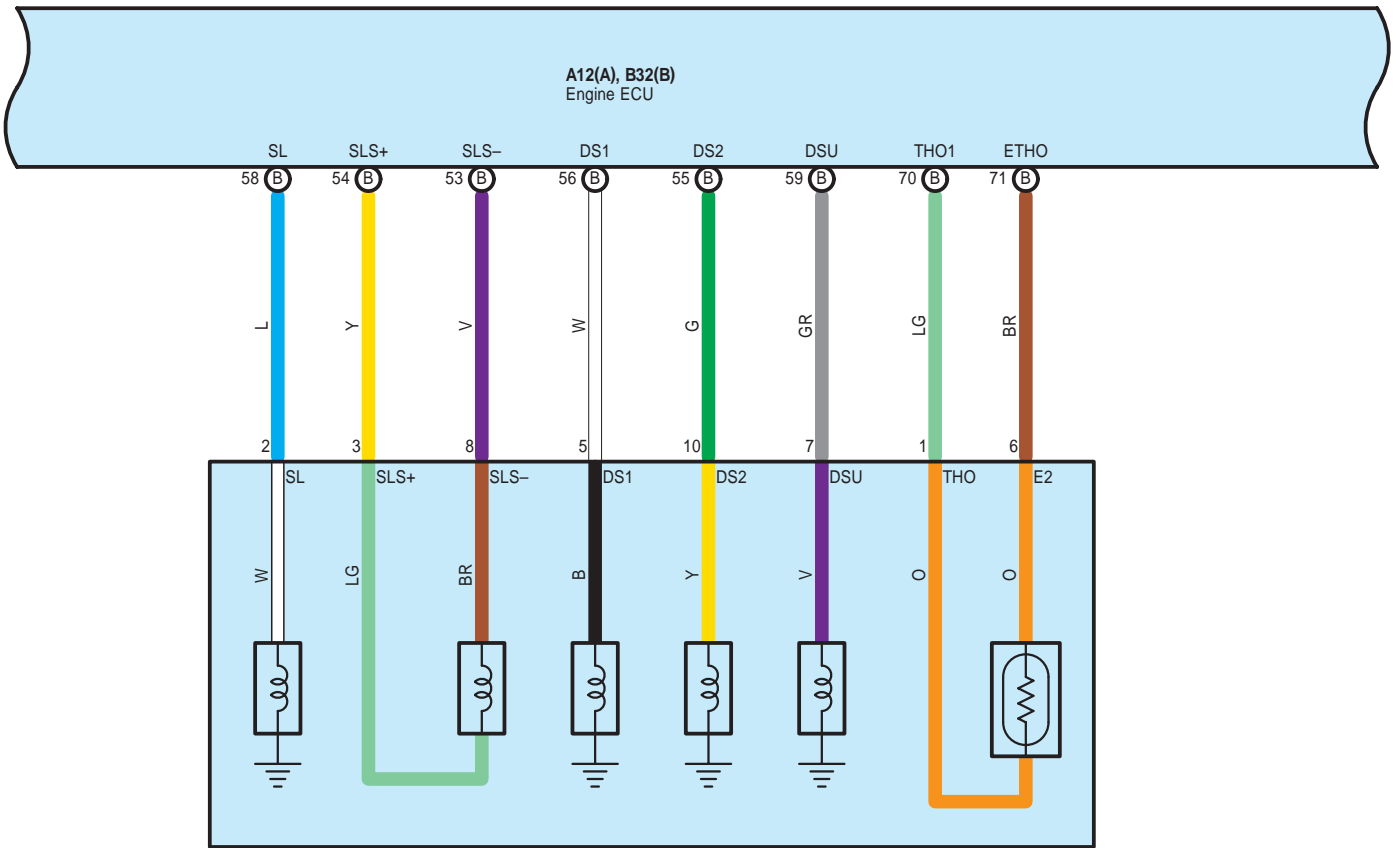

B29
ECT Solenoid

* 5 : Shielded

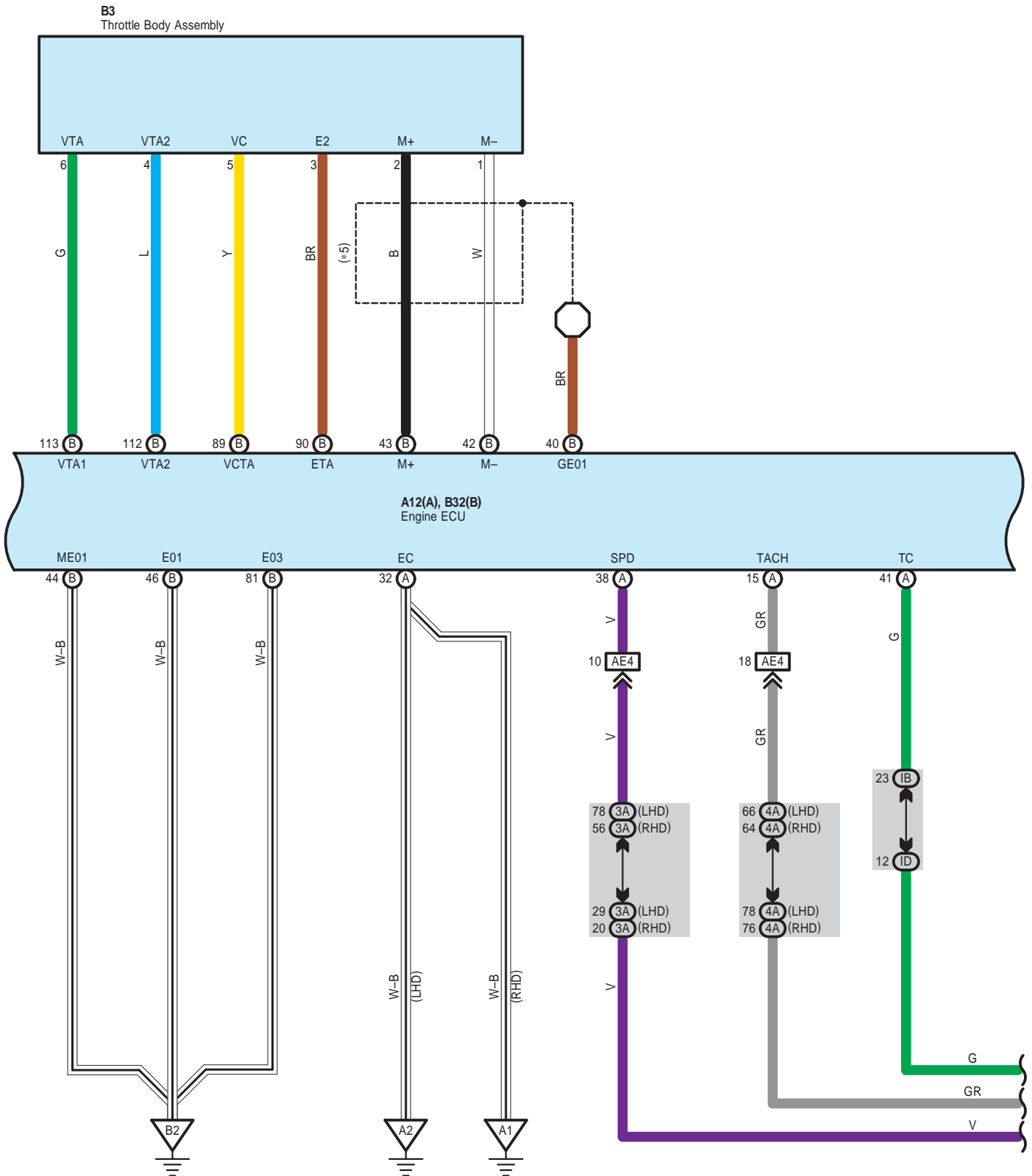

Cruise Control <3ZR-FAE>

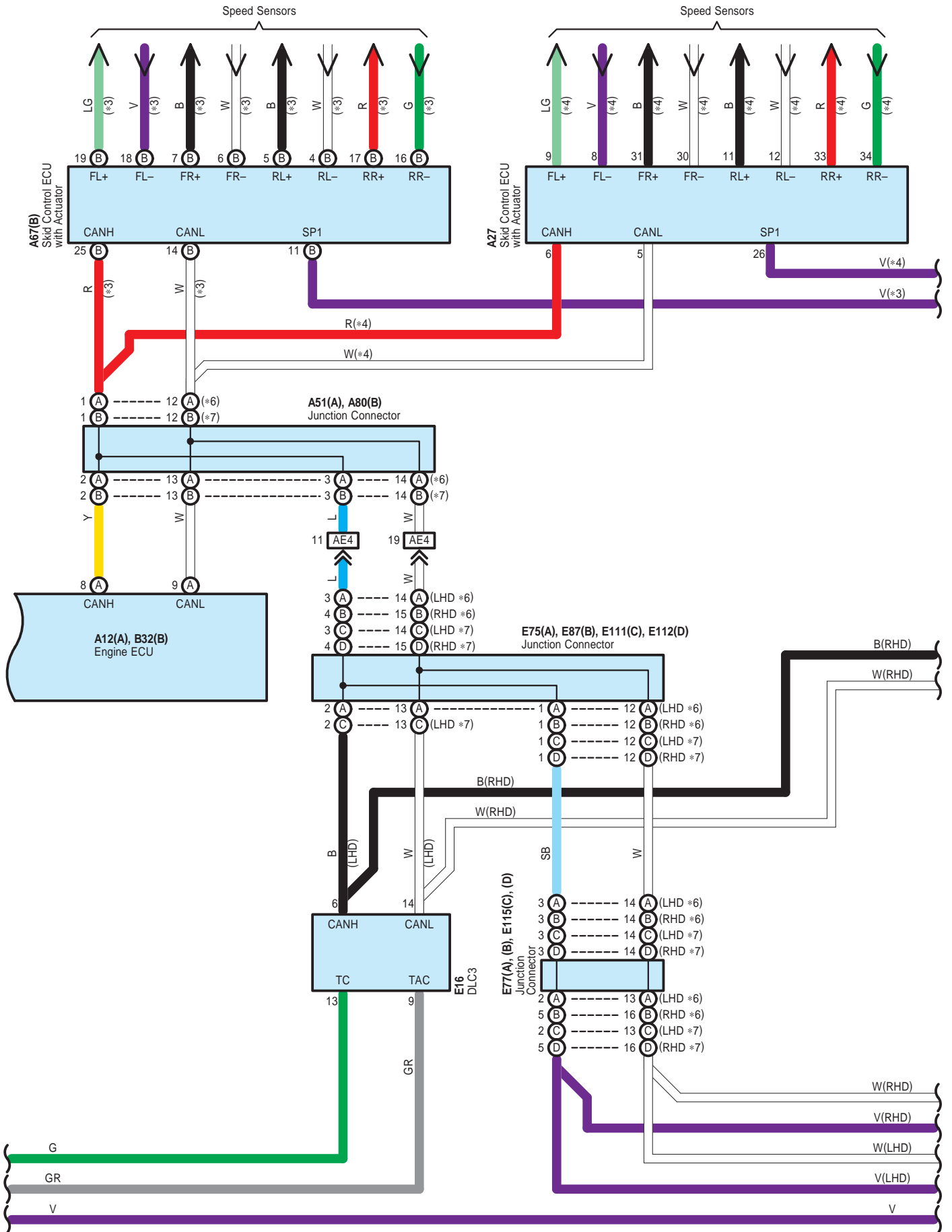

- * 3 : w/ VSC
- * 4 : w/o VSC
- * 6 : Before Feb. 2010 Production
- * 7 : From Feb. 2010 Production

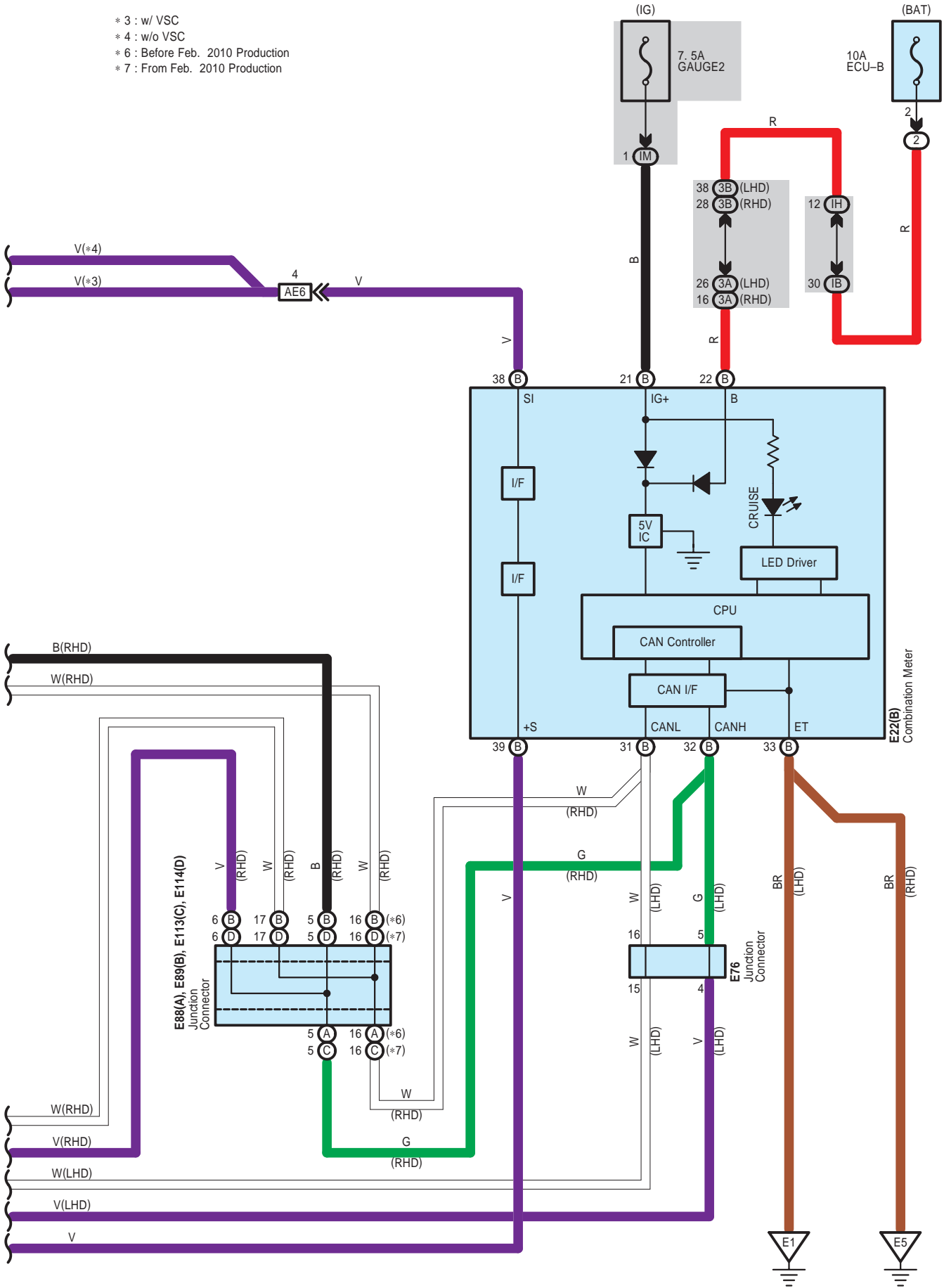

Cruise Control <3ZR-FAE>

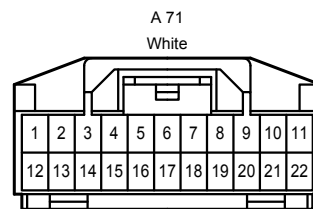
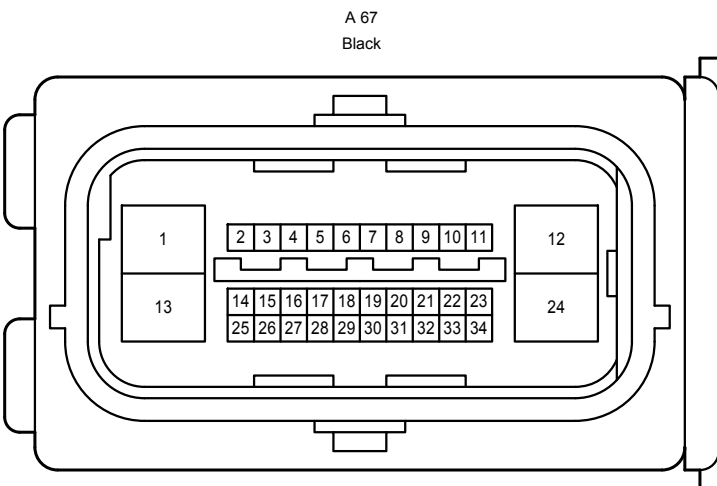
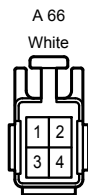
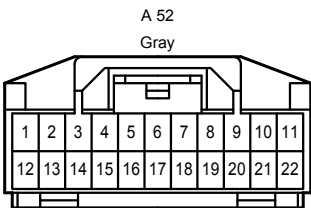
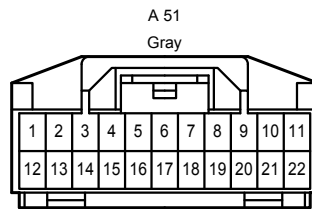
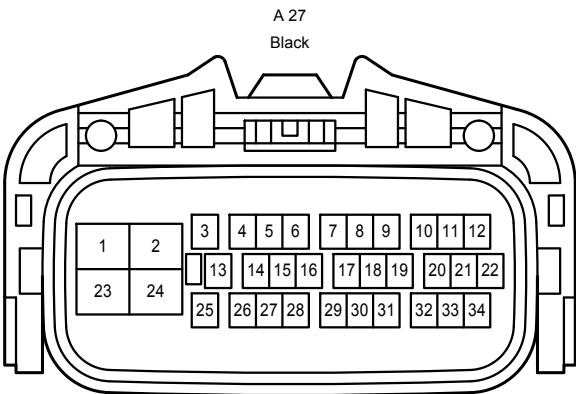
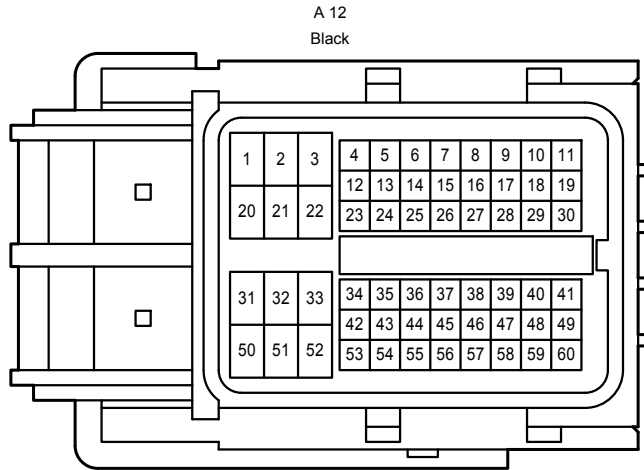
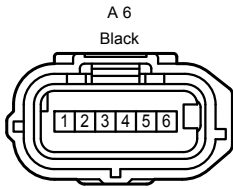
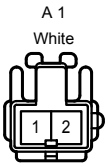

Cruise Control <3ZR-FAE>

E 84

White

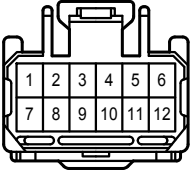

E 85

White

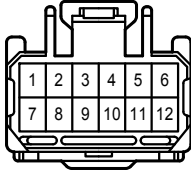

E 87

Gray

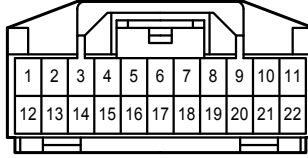

E 88

Blue

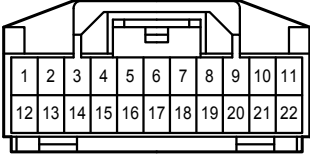

E 89

Blue

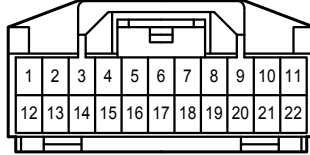

E 97

Blue

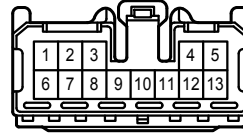

E 98

White

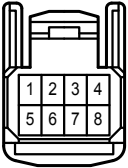

E111

Gray

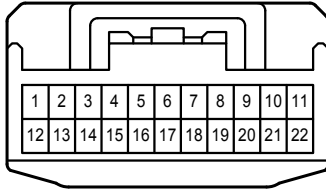

E112

Gray

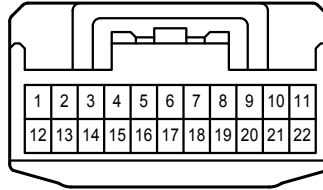

E113

Black

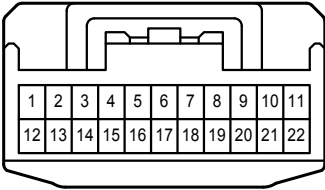

E114

Black

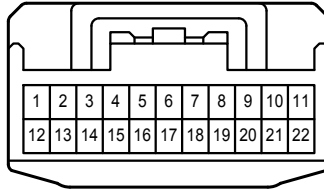

E115

Gray

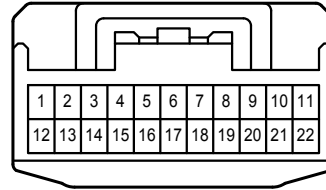

1A

White

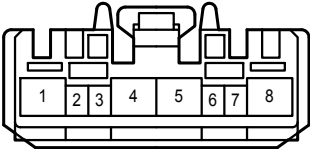

3A

White

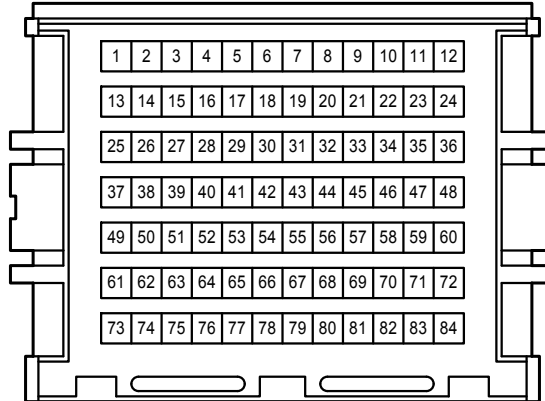

3B
White

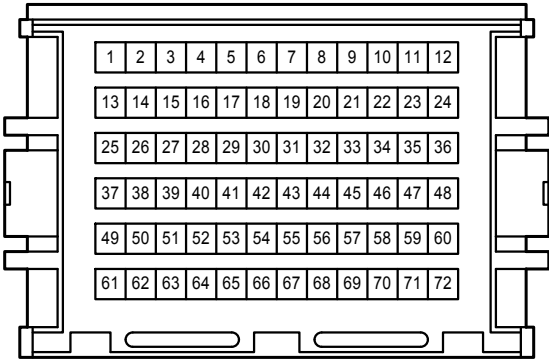

4A
White

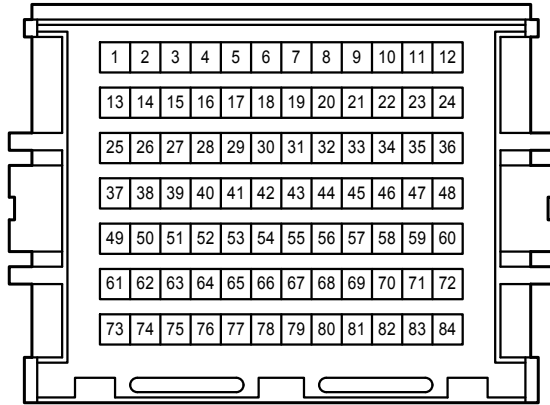

4B
White

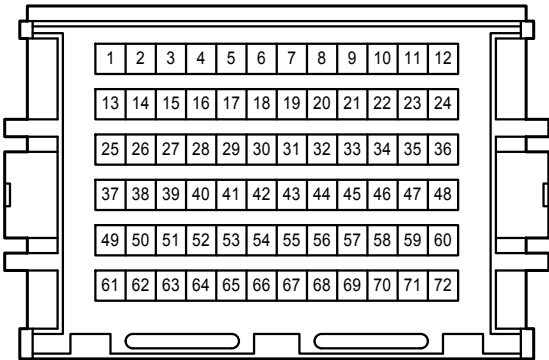

1B
White

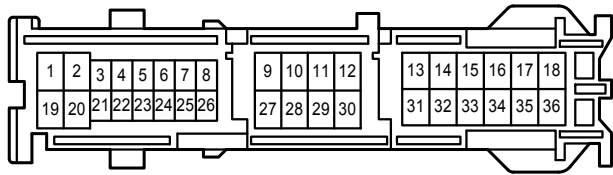

1D
White

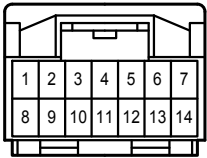

1E
White

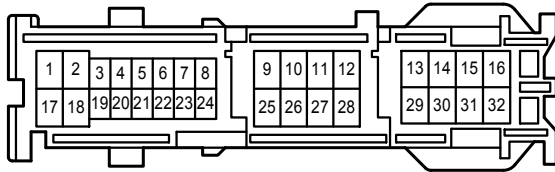

1H
White

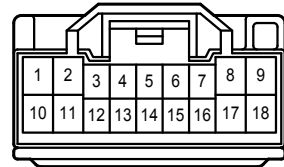

1M
White

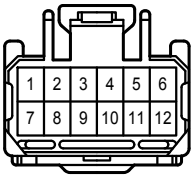

AE3
Black

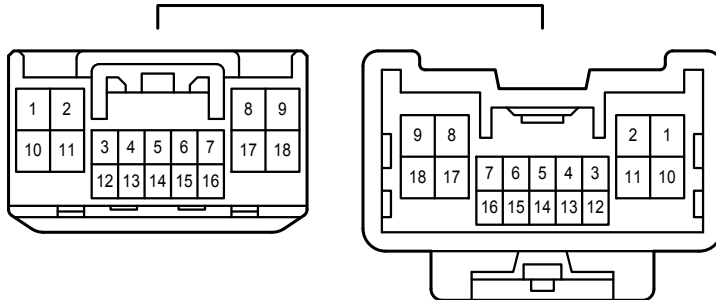

AE4
Gray

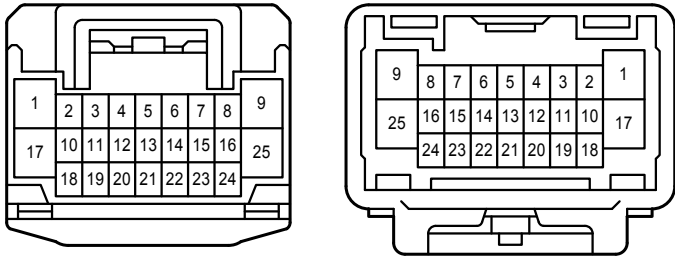

AE6
White

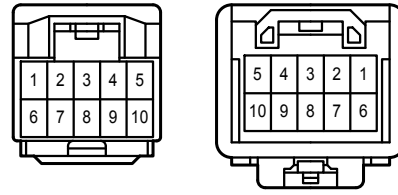

BA1
White

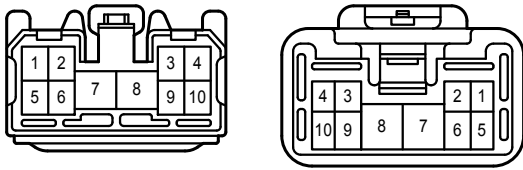

BA2
Gray

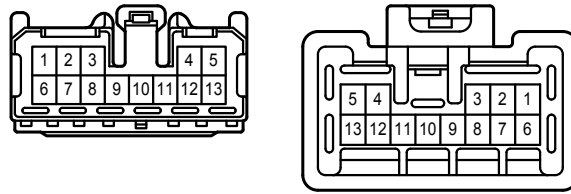

BA4
White

