

Combination Meter

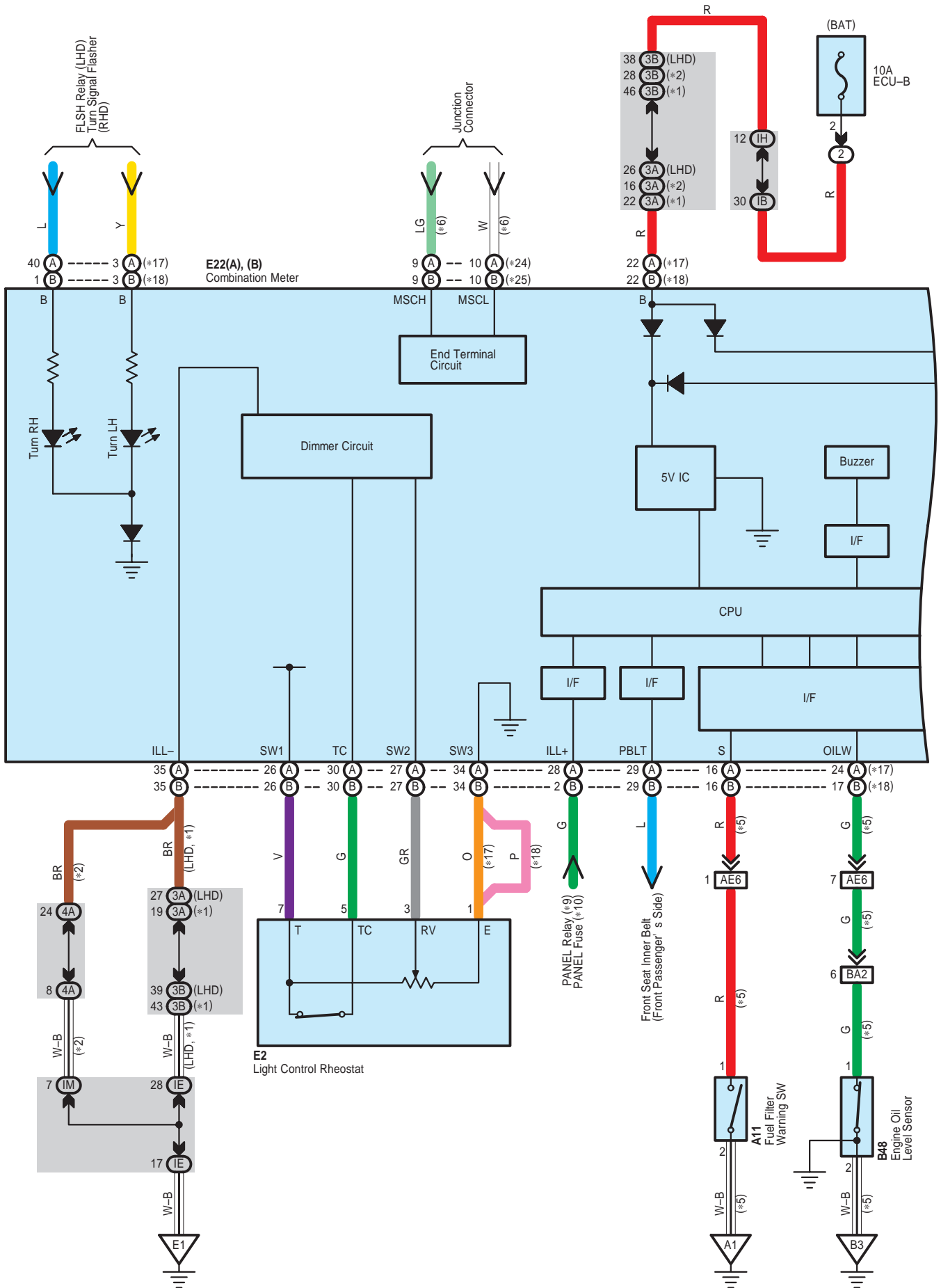

Combination Meter

- * 1 : Australia
- * 2 : RHD Except Australia
- * 3 : Europe
- * 4 : Except Europe
- * 5 : Diesel
- * 6 : w/ Entry & Start System
- * 7 : Automatic A/C
- * 8 : Manual A/C
- * 9 : w/ Daytime Running Light
- * 10 : w/o Daytime Running Light
- * 17 : Before Aug. 2008 Production Except Europe,
Before Dec. 2008 Production Europe
- * 18 : From Aug. 2008 Production Except Europe,
From Dec. 2008 Production Europe
- * 20 : From Aug. 2008 Production Except Europe
- * 24 : Before Dec. 2008 Production Europe
- * 25 : From Dec. 2008 Production Europe

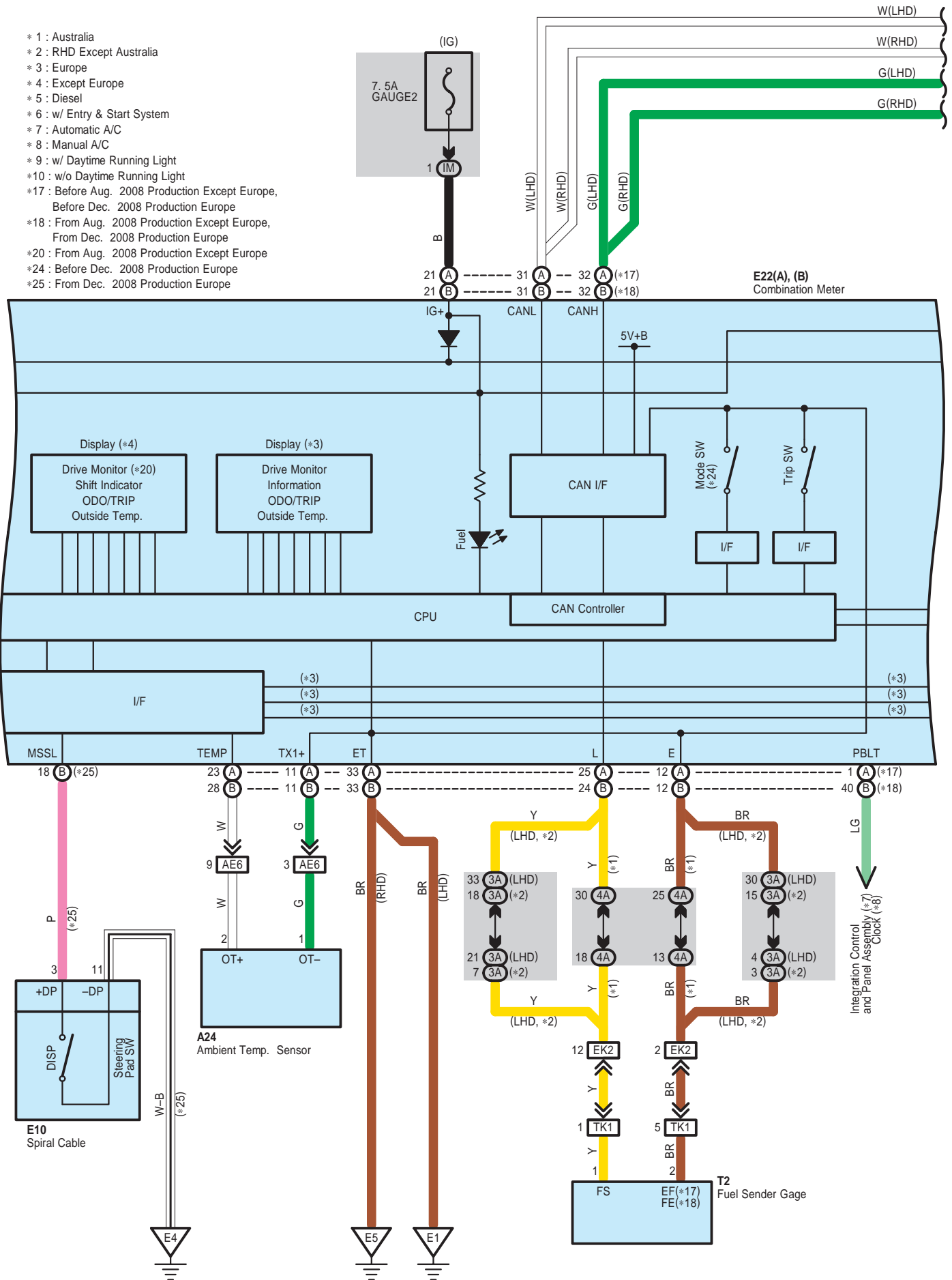

Combination Meter

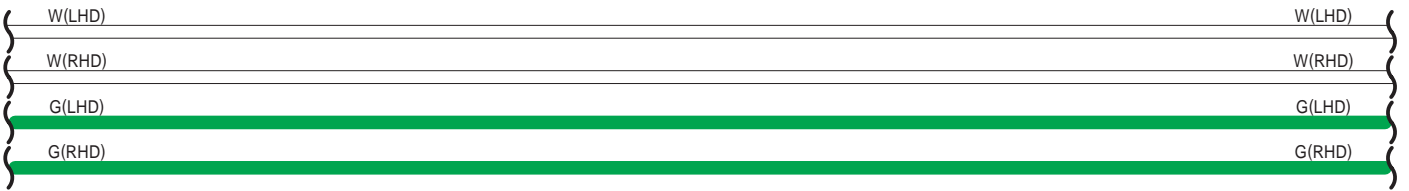

E22(A), (B)
Combination Meter

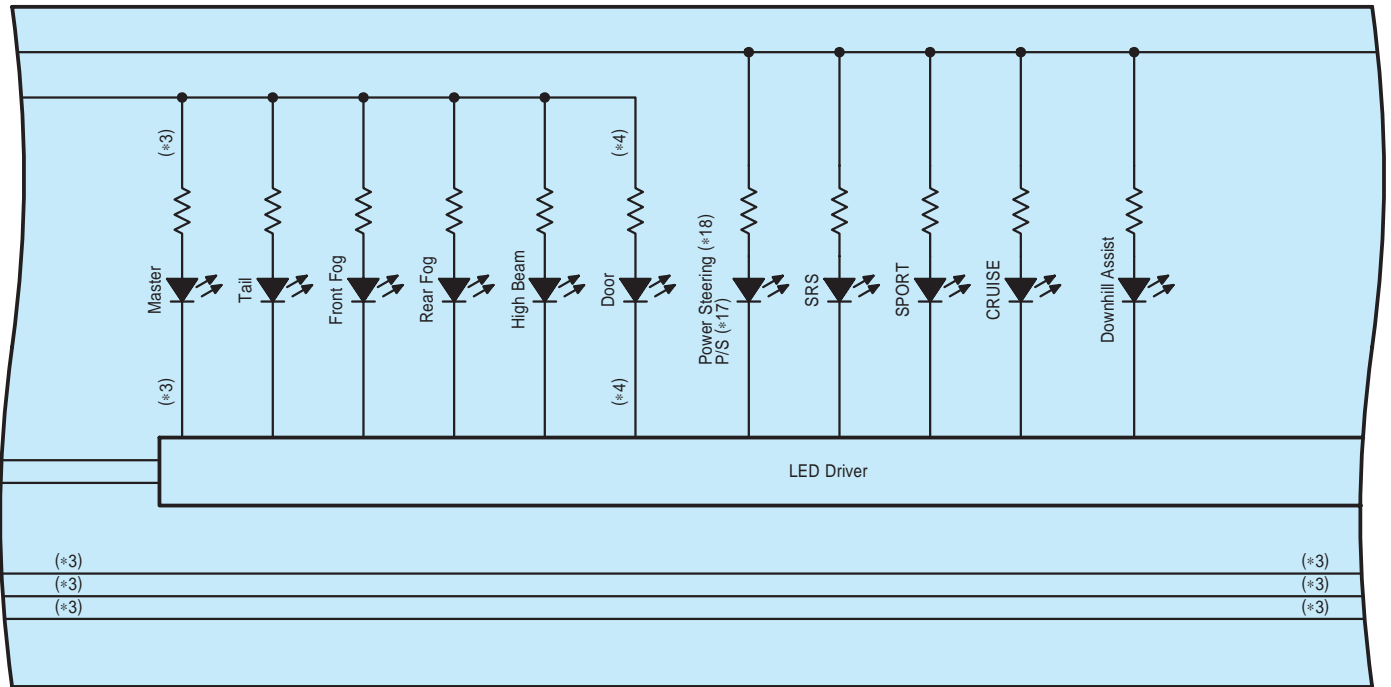

Combination Meter

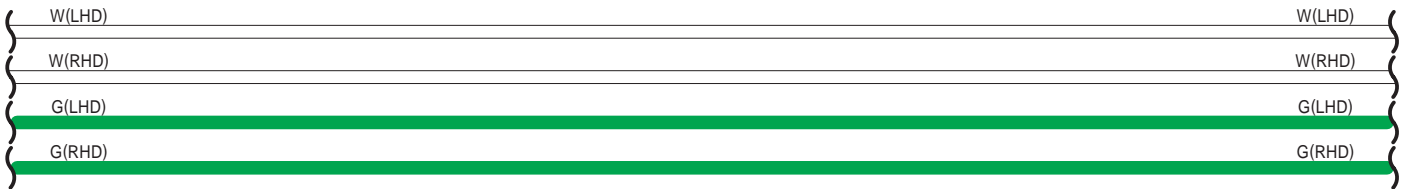

E22(A), (B)
Combination Meter

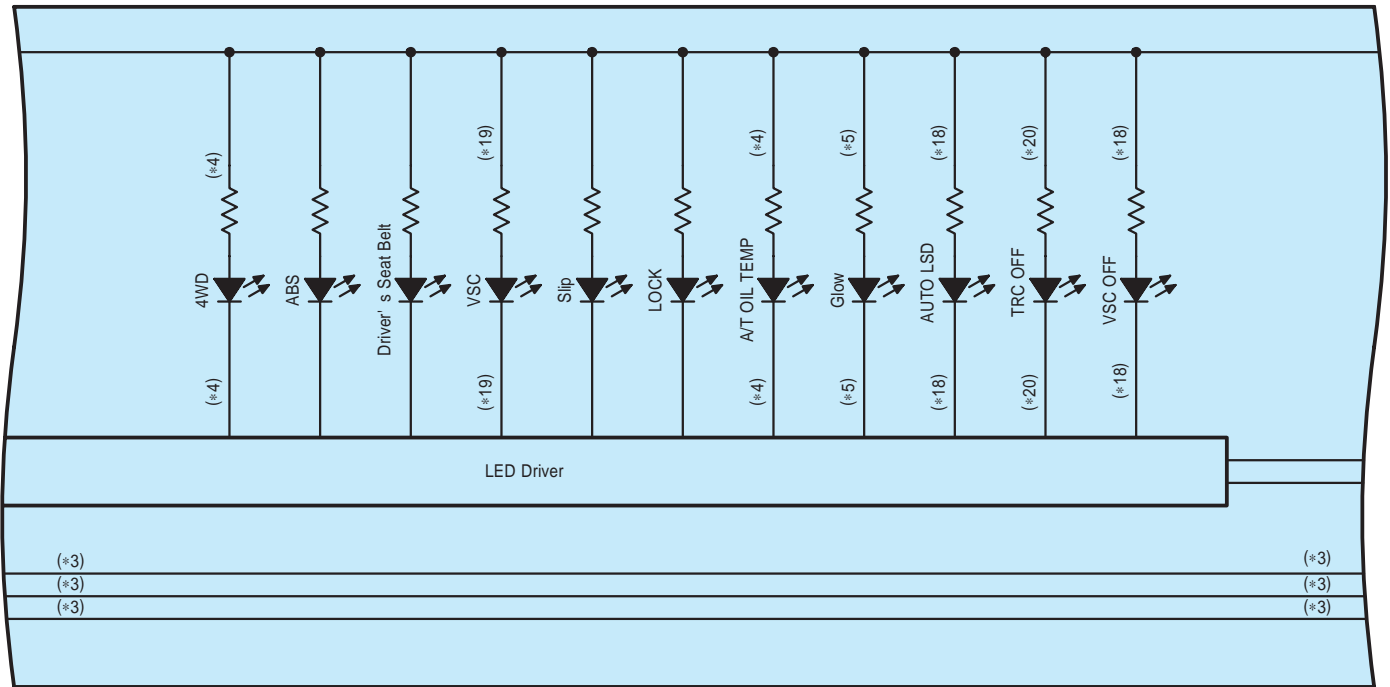

- * 3 : Europe
- * 4 : Except Europe
- * 5 : Diesel
- *17 : Before Aug. 2008 Production Except Europe,
Before Dec. 2008 Production Europe
- *18 : From Aug. 2008 Production Except Europe,
From Dec. 2008 Production Europe
- *19 : Before Aug. 2008 Production Except Europe
- *20 : From Aug. 2008 Production Except Europe

Combination Meter

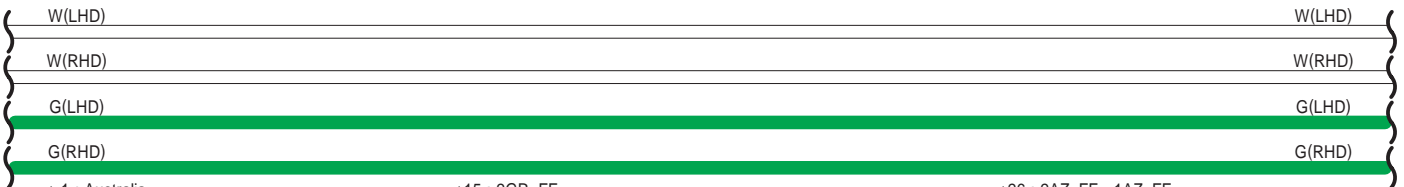

- | | | |
|---|--|---|
| <ul style="list-style-type: none"> * 1 : Australia * 2 : RHD Except Australia * 3 : Europe * 4 : Except Europe * 5 : Diesel * 6 : w/ Entry & Start System * 11 : Gasoline Except 3ZR-FAE * 12 : w/ Navigation System (Map Type) * 13 : w/o Navigation System (Turn by Turn Type) * 14 : Except 2GR-FE | <ul style="list-style-type: none"> * 15 : 2GR-FE * 16 : Gasoline Except 2GR-FE * 17 : Before Aug. 2008 Production Except Europe, Before Dec. 2008 Production Europe * 18 : From Aug. 2008 Production Except Europe, From Dec. 2008 Production Europe * 21 : From Aug. 2008 Production 2GR-FE * 22 : Except *21 * 23 : 3ZR-FAE * 24 : Before Dec. 2008 Production Europe * 25 : From Dec. 2008 Production Europe | <ul style="list-style-type: none"> * 26 : 2AZ-FE, 1AZ-FE * 27 : RHD w/ Hood Molding * 28 : RHD w/o Hood Molding * 29 : Before Feb. 2010 Production * 30 : From Feb. 2010 Production * 31 : From Apr. 2011 Production *1 |
|---|--|---|

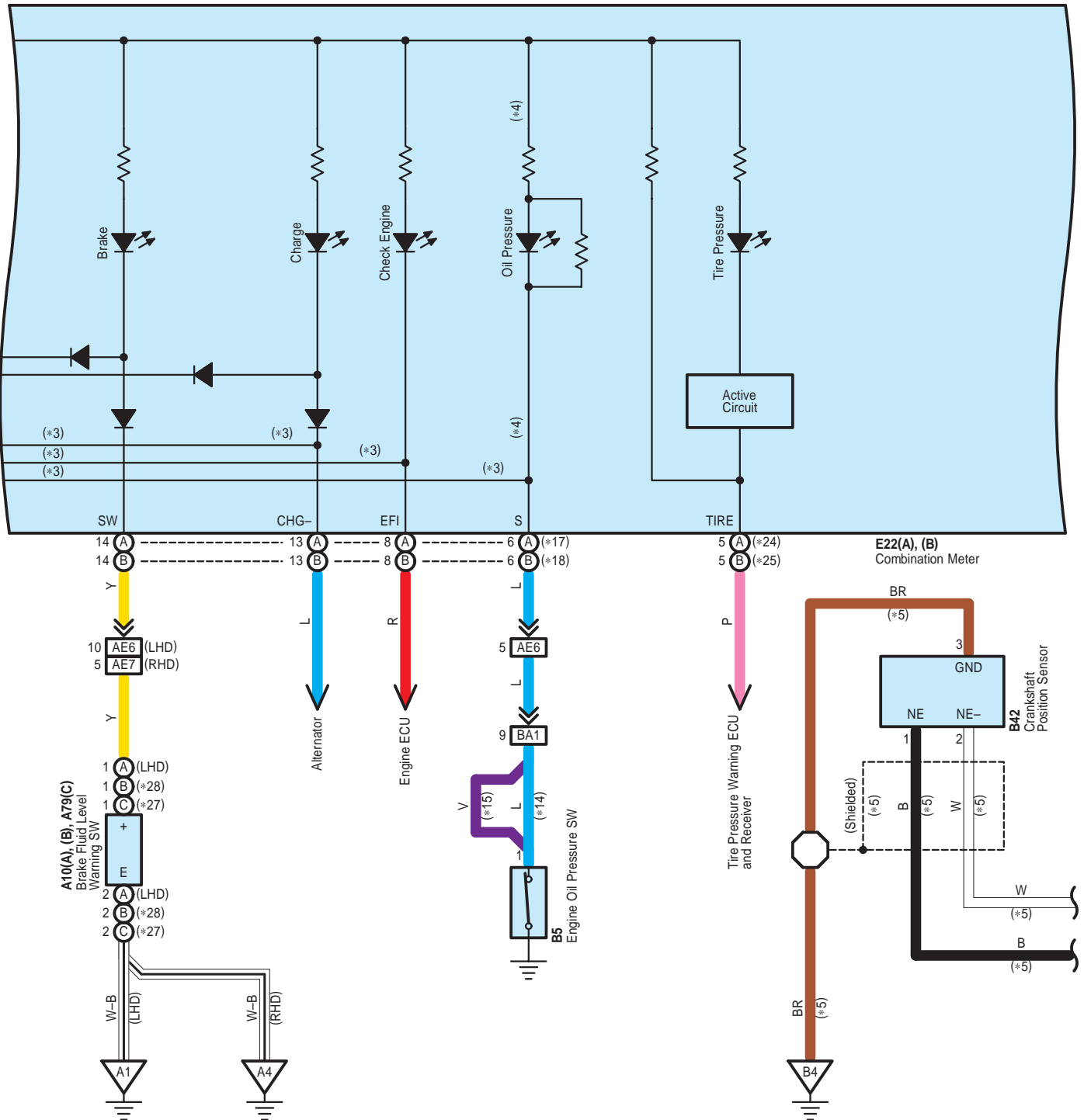

Combination Meter

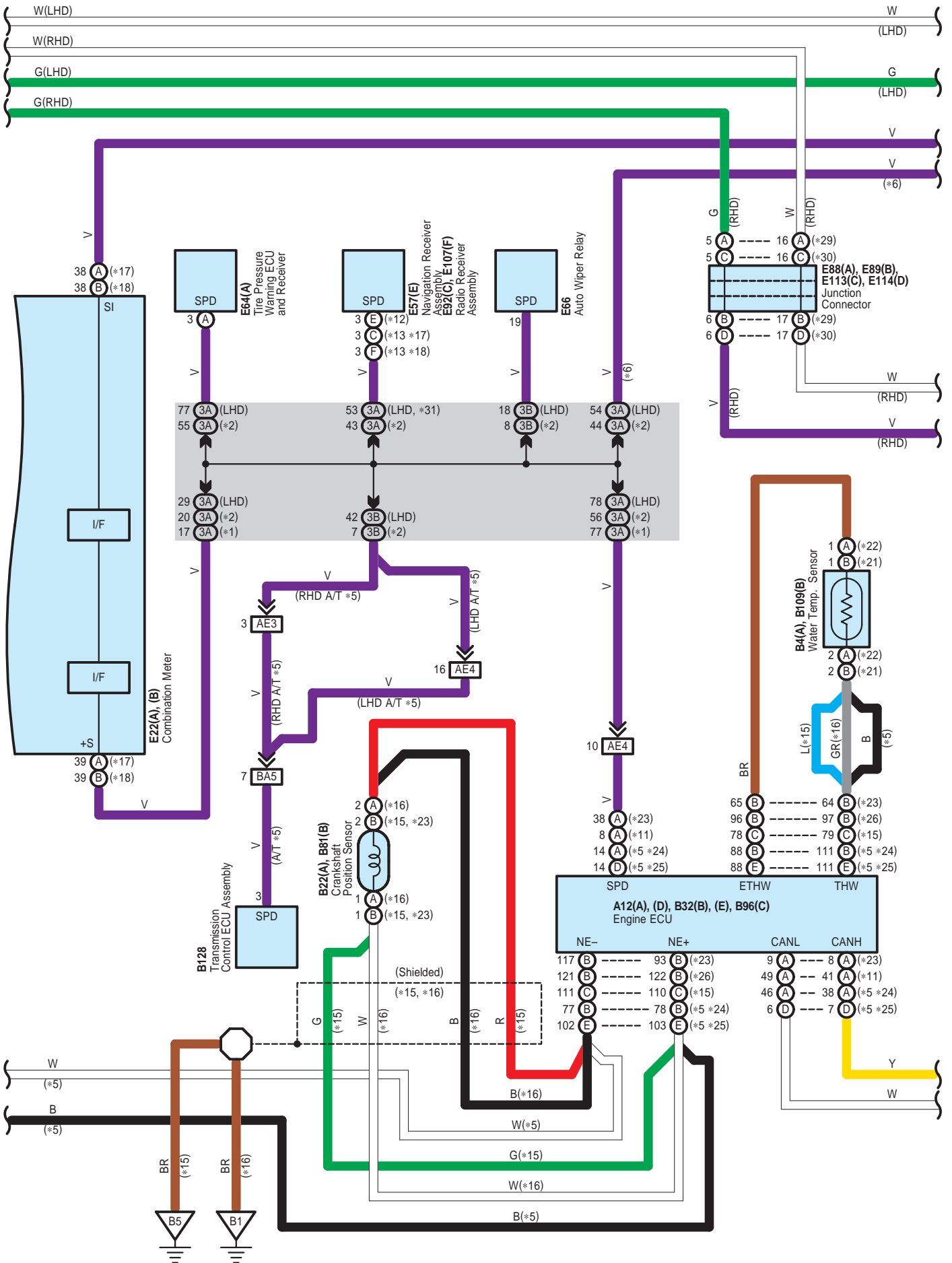

Combination Meter

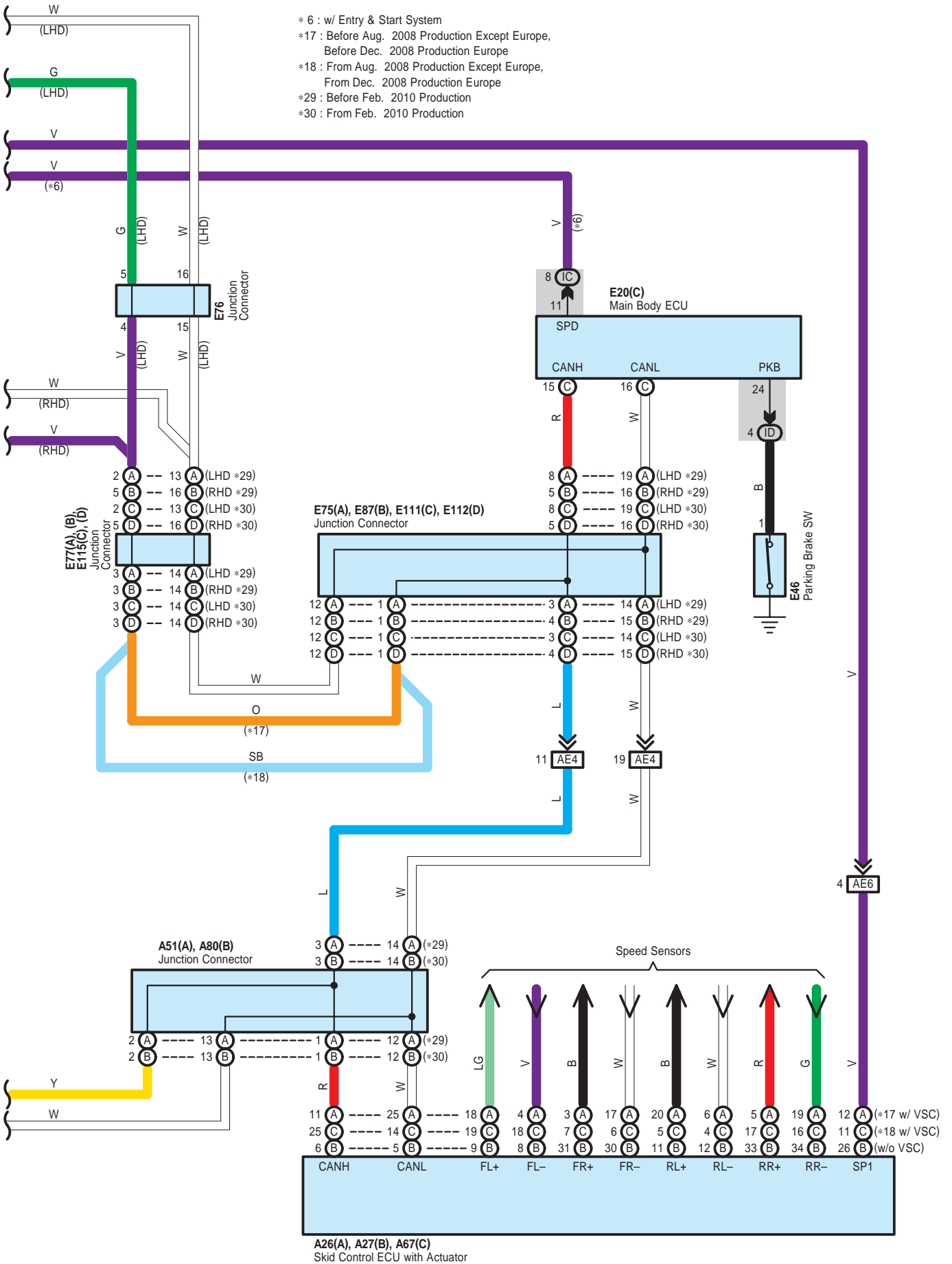

Combination Meter

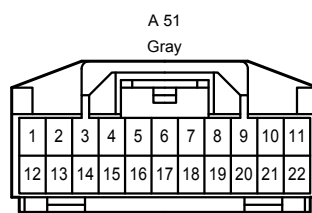
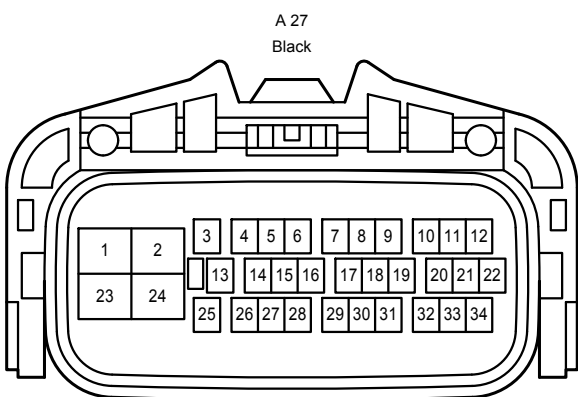
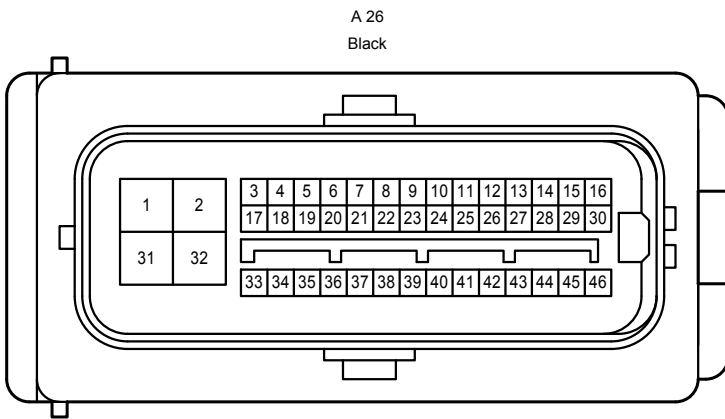
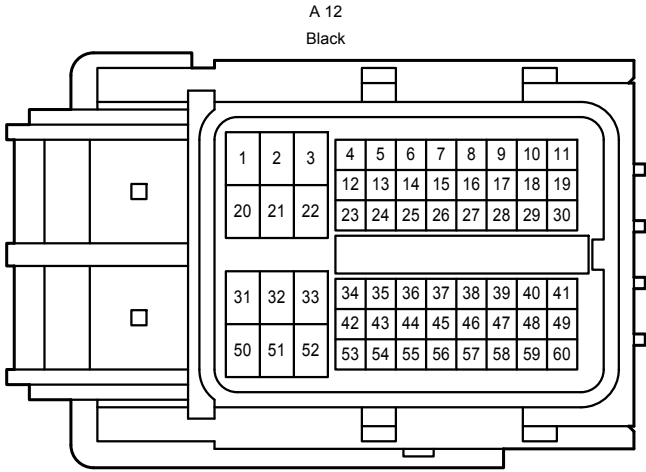

Combination Meter

A 67
Black

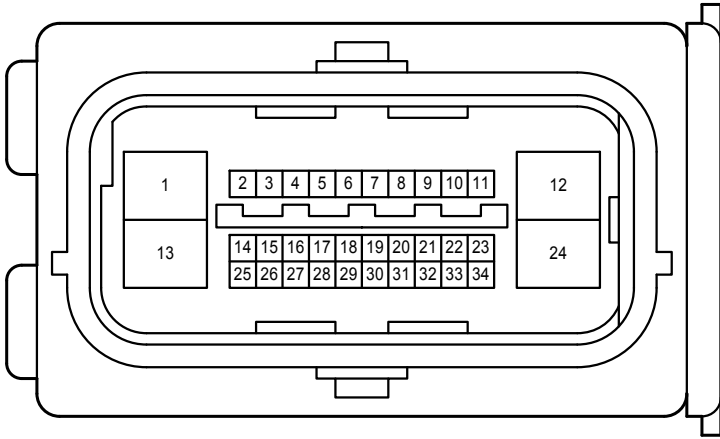

A 79
Gray



A 80
Gray

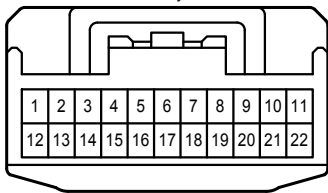

B 4
Gray



B 5
Gray



B 22
Gray



B 32
Black

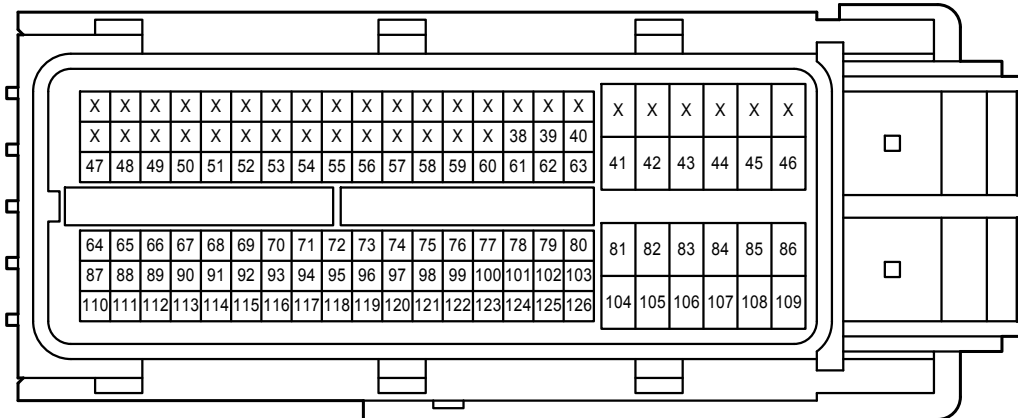

B 42
Gray

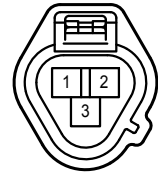

B 48
Gray



B 81
Black

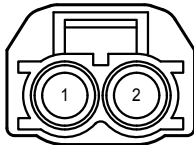

Combination Meter

B 96
Black

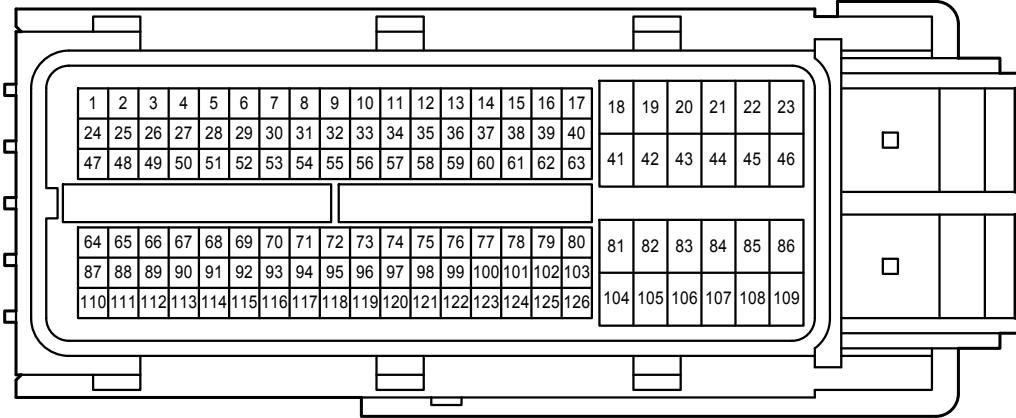

B109
Black



B128
Gray

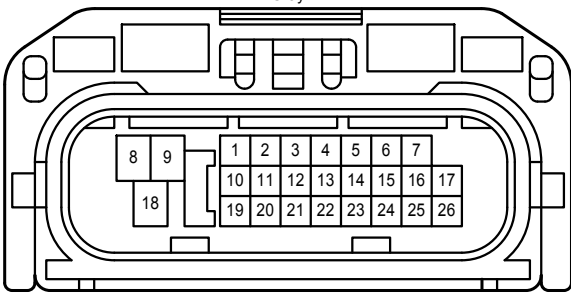

E 2
White

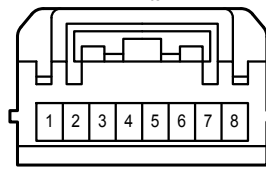

E 10
Black

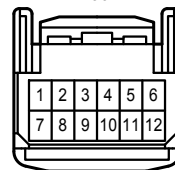

E 20
White

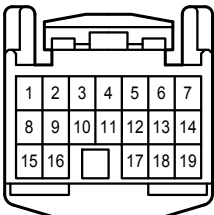

E 22
White

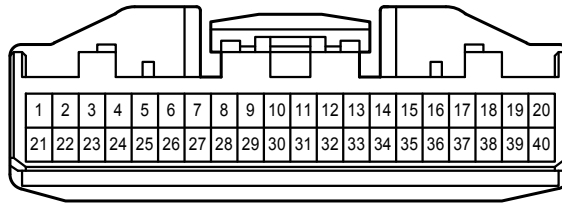

E 46
Black



E 57
Gray

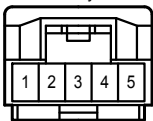

E 64
Black

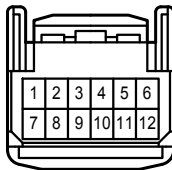

E 66
White

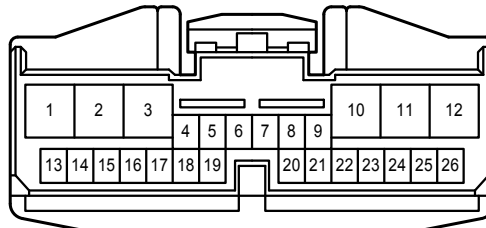

E 75
Gray

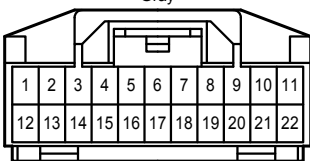

E 76
Black

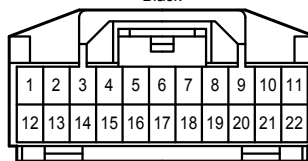

E 77
Gray

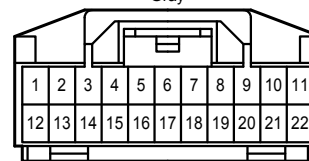

Combination Meter

E 87
Gray

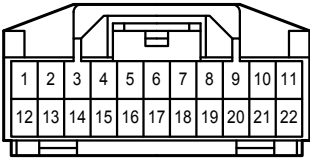

E 88
Blue

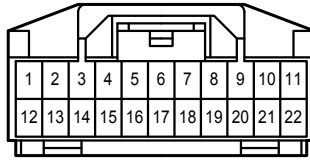

E 89
Blue

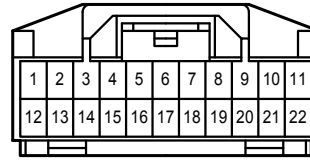

E 92
White

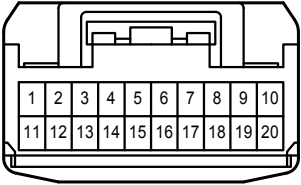

E107
Blue

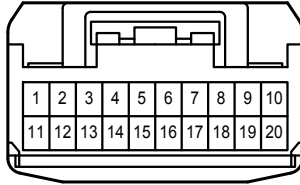

E111
Gray

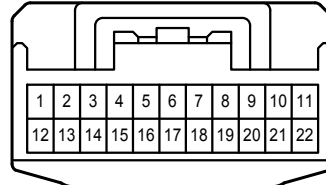

E112
Gray

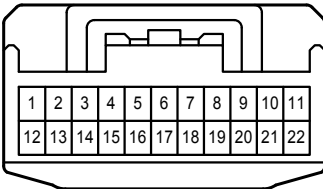

E113
Black

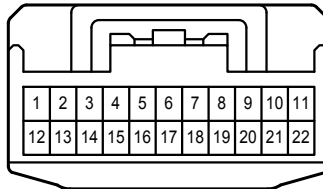

E114
Black

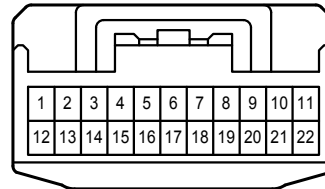

E115
Gray

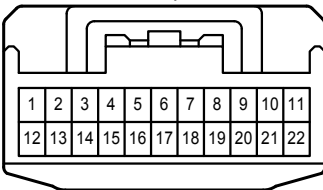

T 2
White

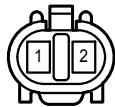

3A
White

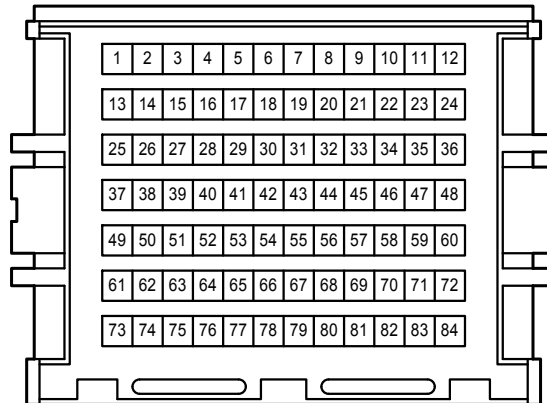

3B
White

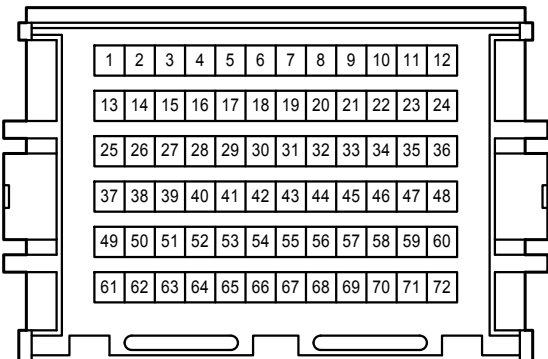

4A
White

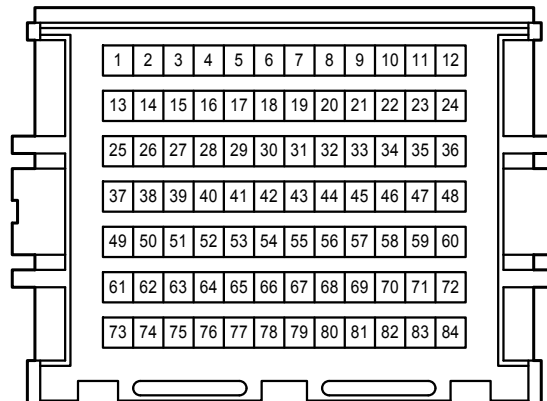

Combination Meter

IB
White

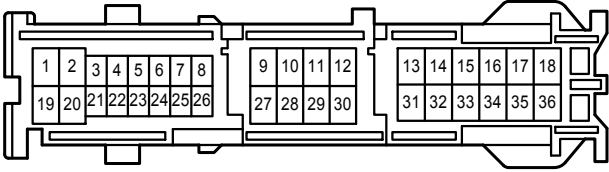

IC
White

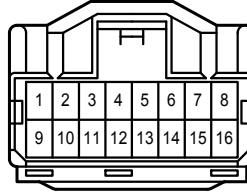

ID
White

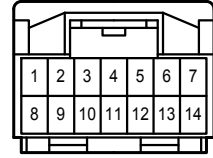

IE
White

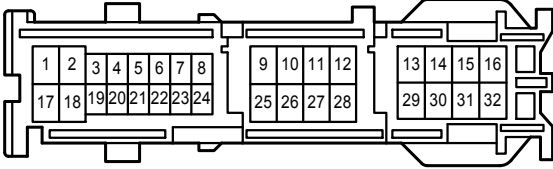

IH
White

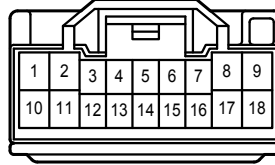

IM
White

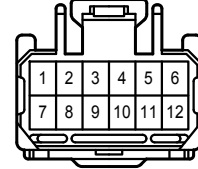

AE3
Black

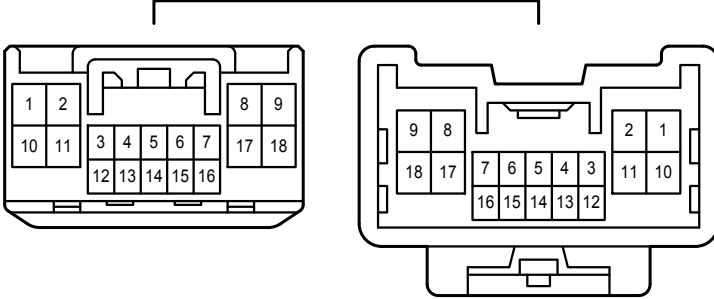

AE4
Gray

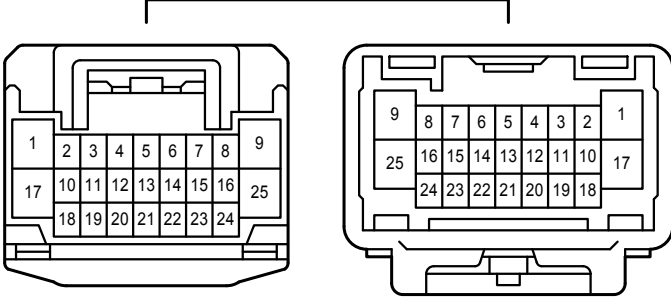

AE6
White

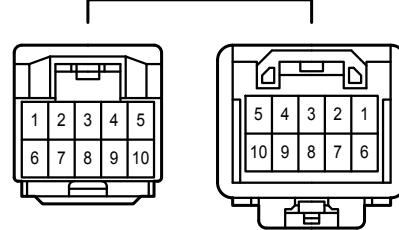

AE7
White

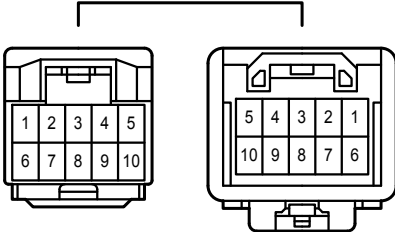

BA1
White

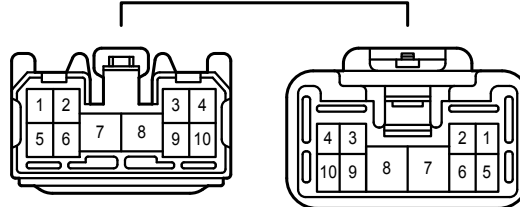

Combination Meter

BA2
Gray

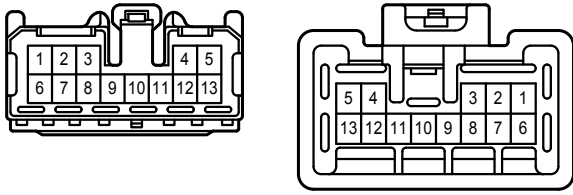

BA5
White
Gray

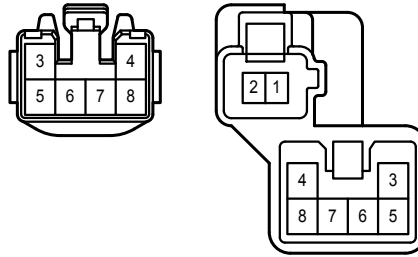

EK2
White

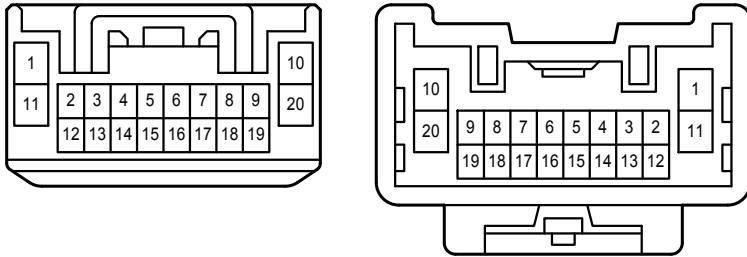

TK1
White

