

Double Locking

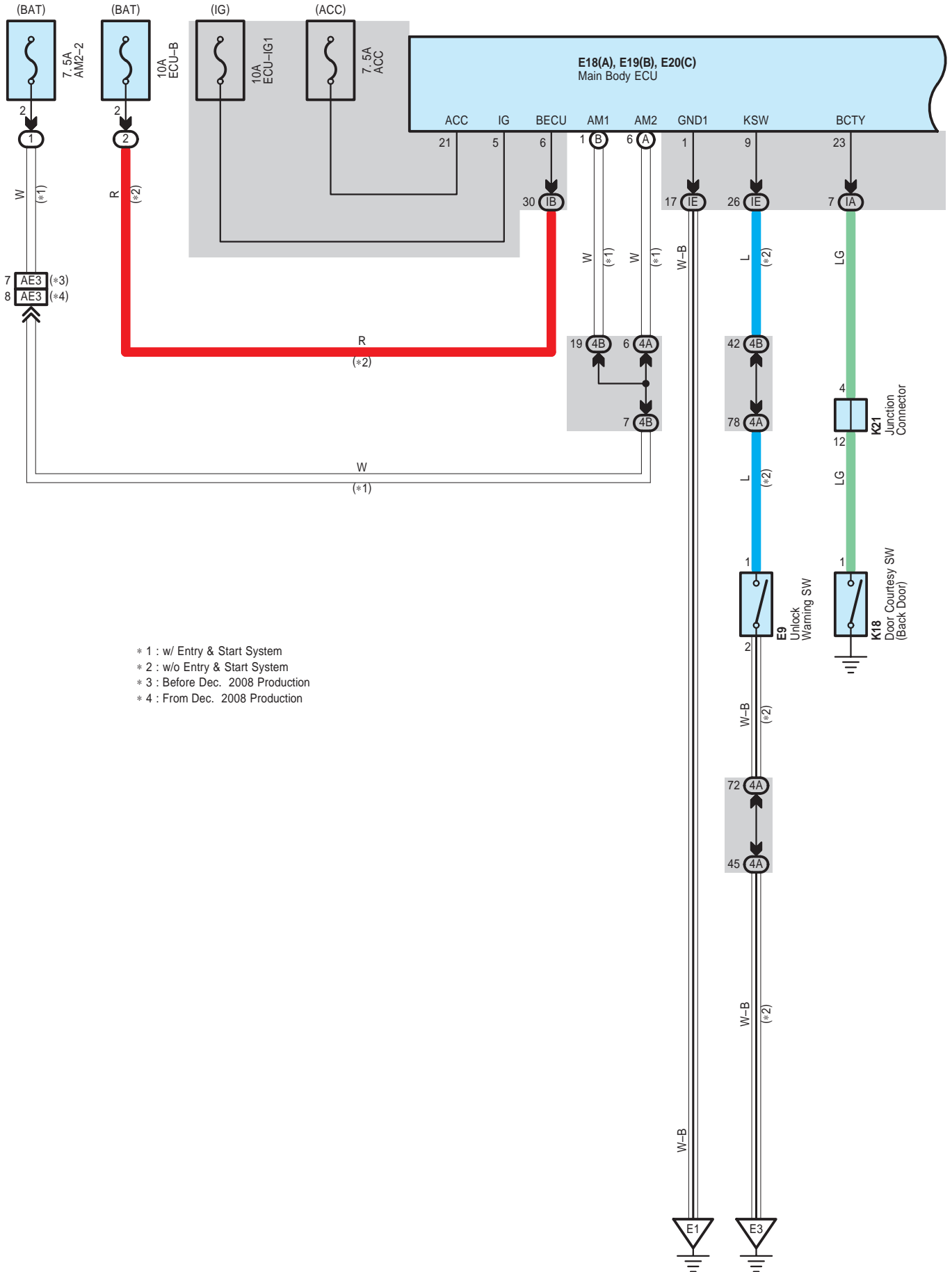

- * 1 : w/ Entry & Start System
- * 2 : w/o Entry & Start System
- * 3 : Before Dec. 2008 Production
- * 4 : From Dec. 2008 Production

Double Locking

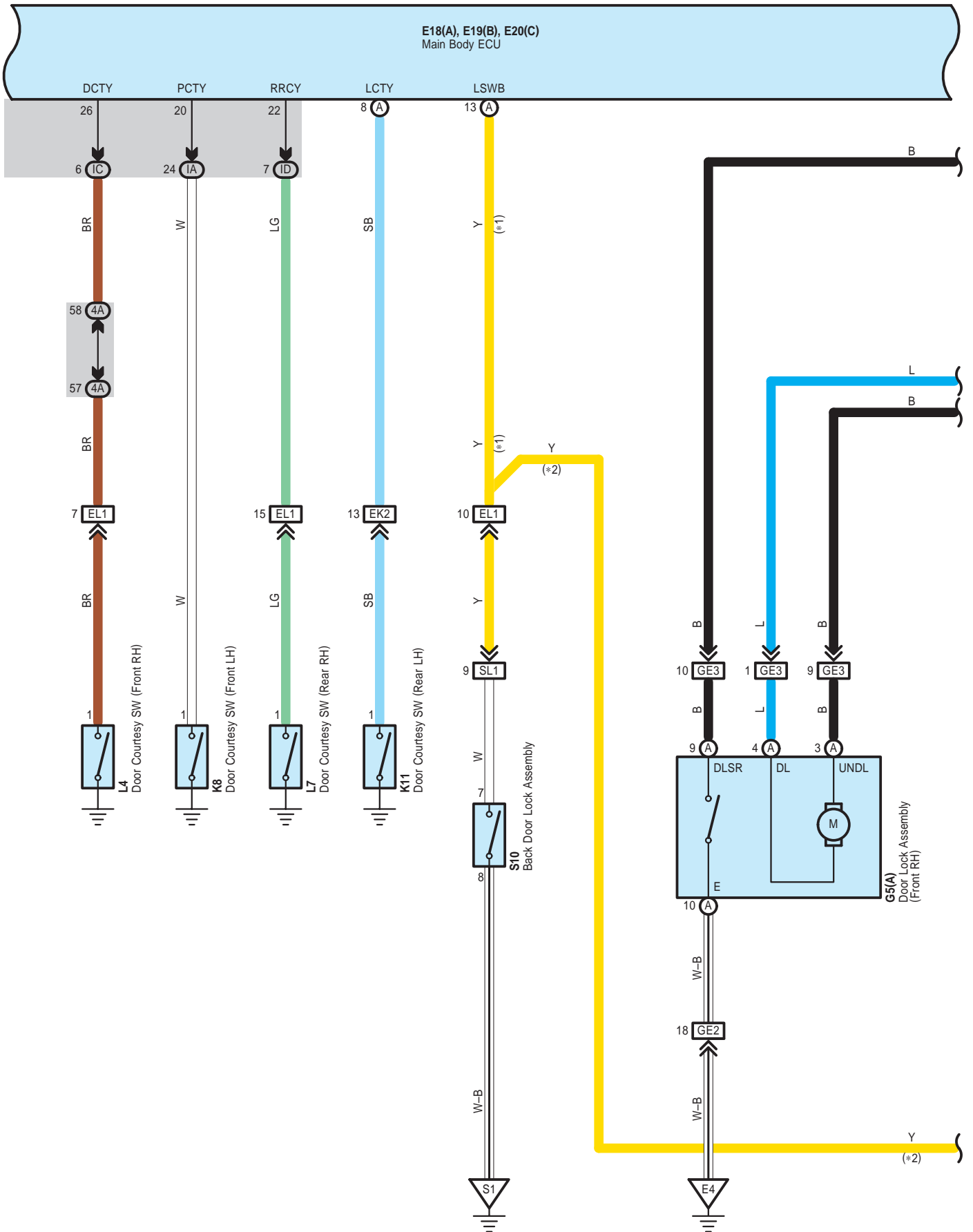

Double Locking

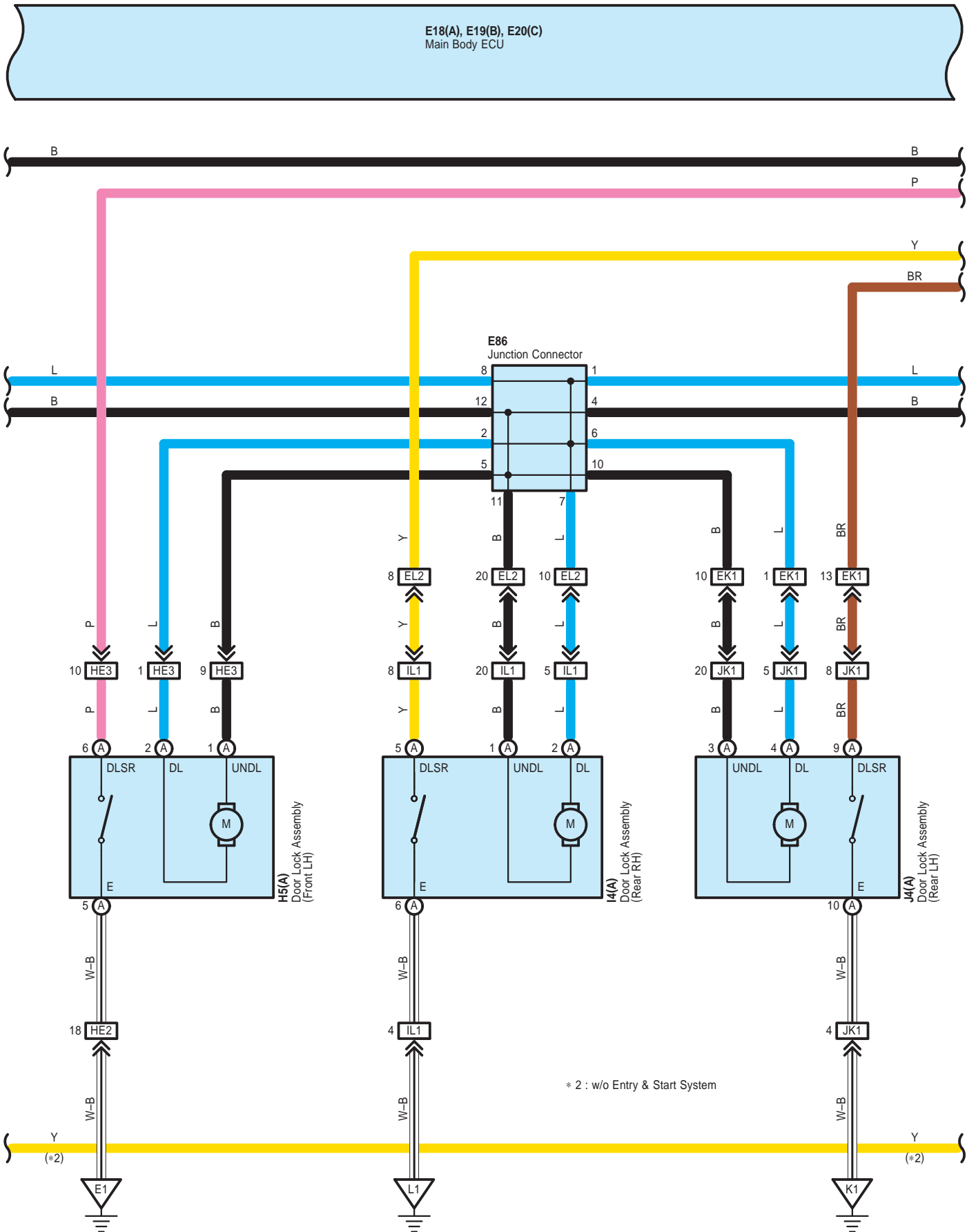

Double Locking

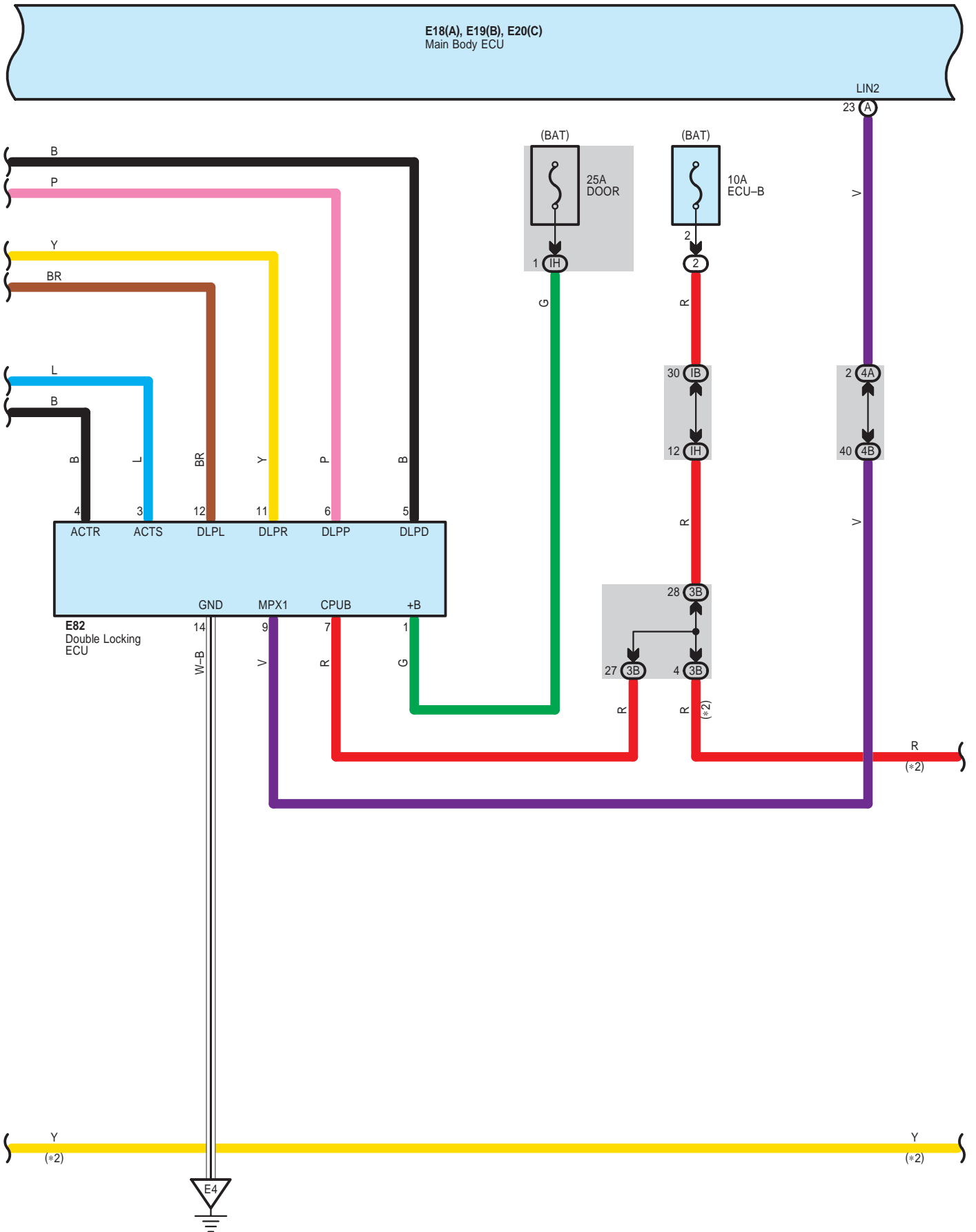

Double Locking

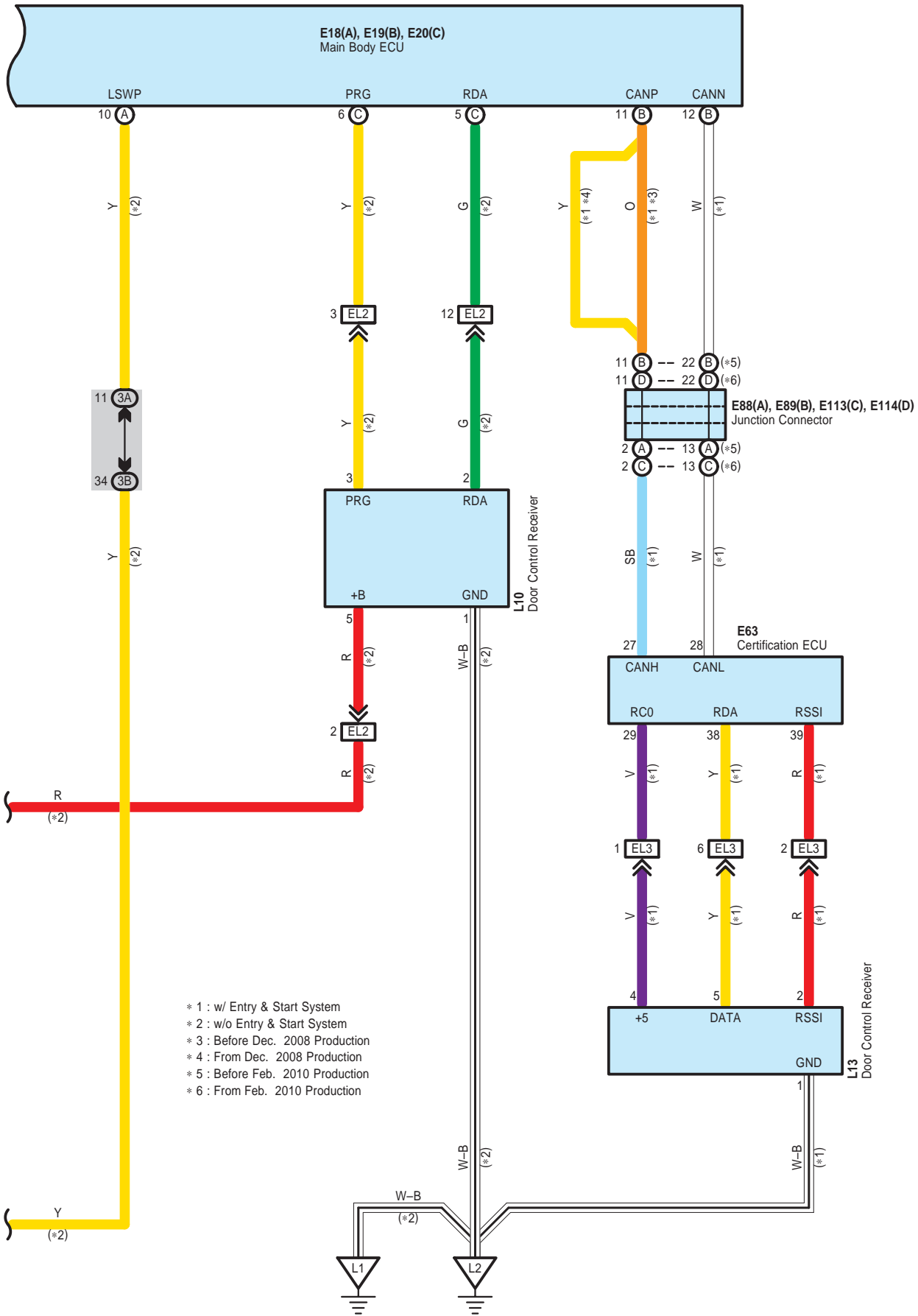

Double Locking

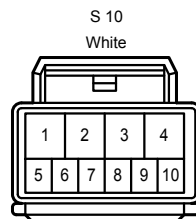
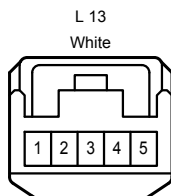
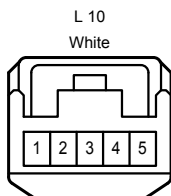
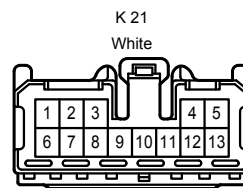
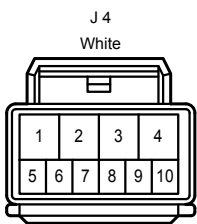
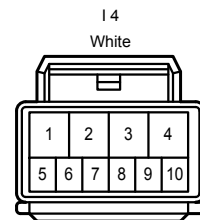
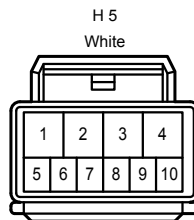
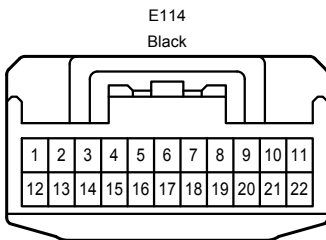
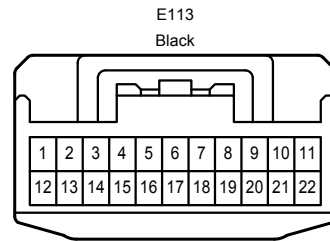
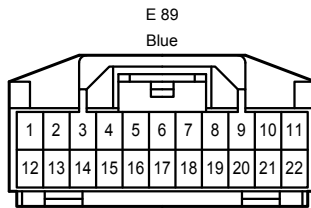
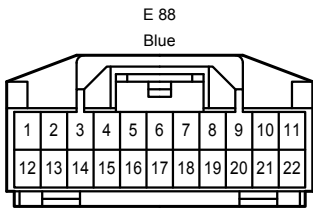
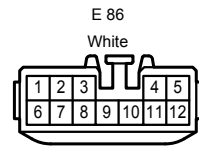
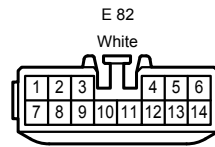
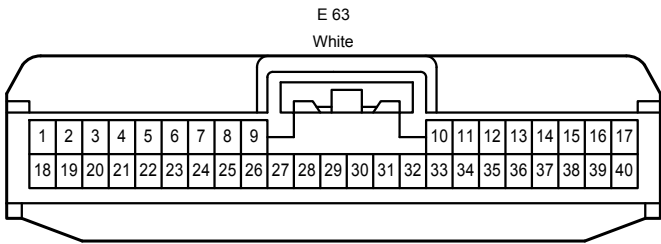
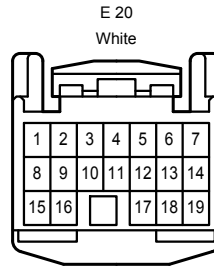
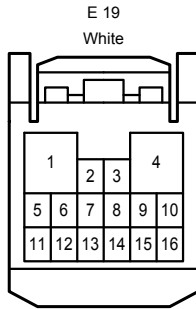
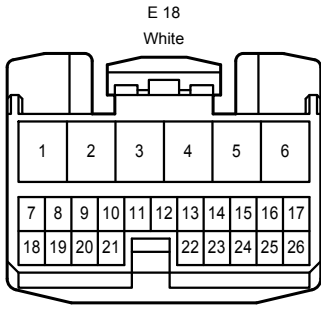

Double Locking

3A
White

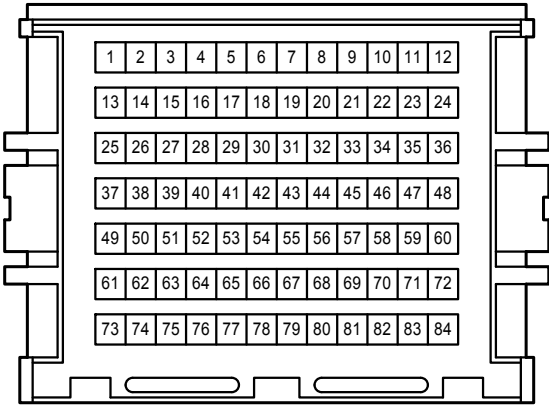

3B
White

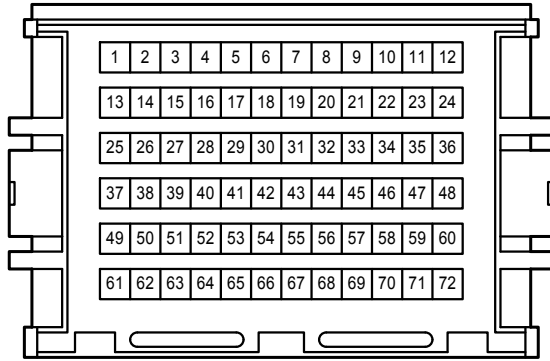

4A
White

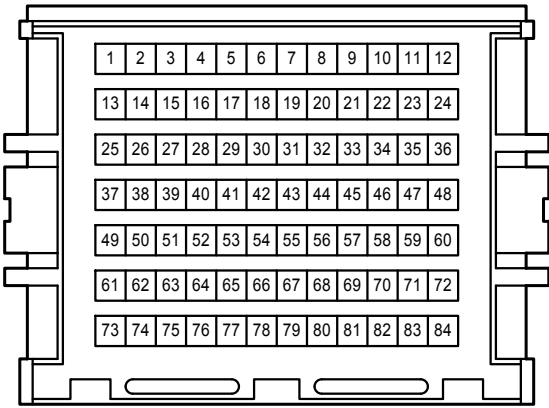

4B
White

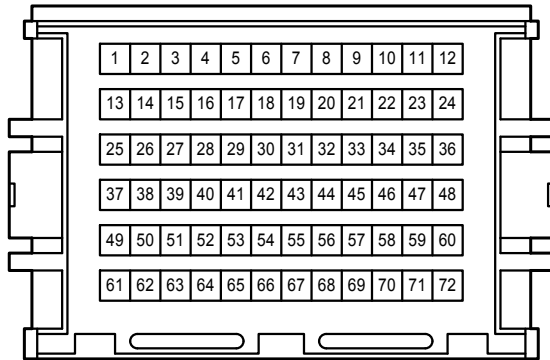

1A
White

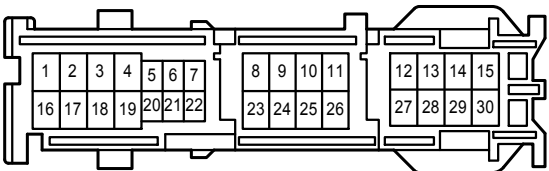

1B
White

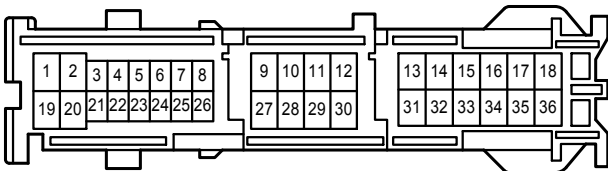

1C
White

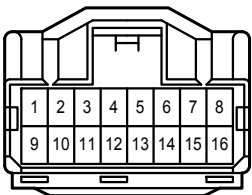

1D
White

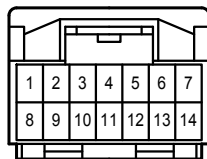

1E
White

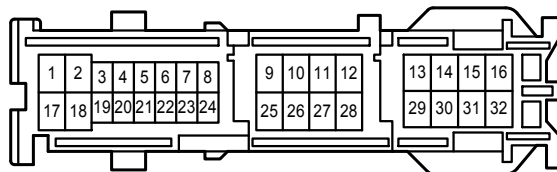

Double Locking

IH
White

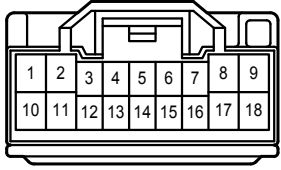

AE3
Black

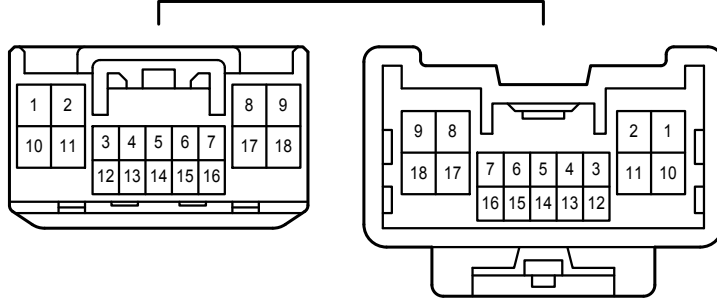

EK1
White

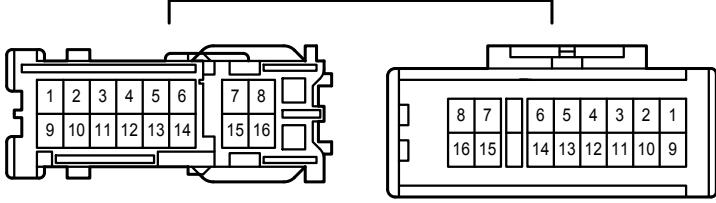

EK2
White

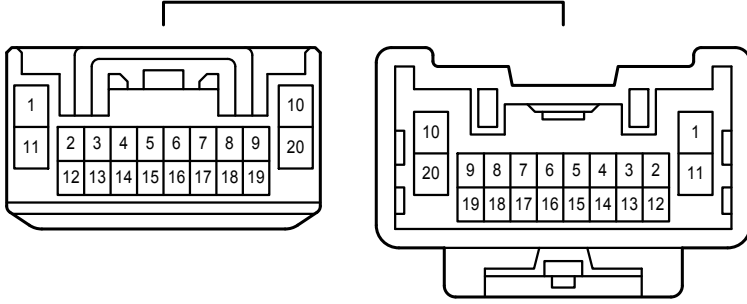

EL1
White

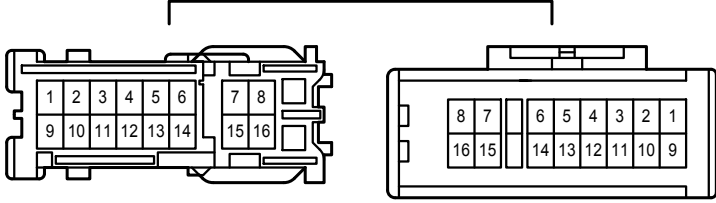

EL2
White

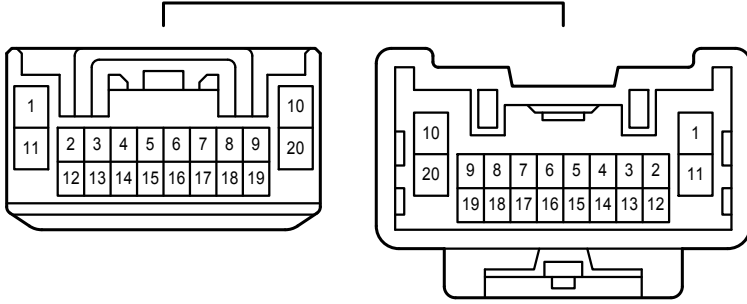

EL3
White

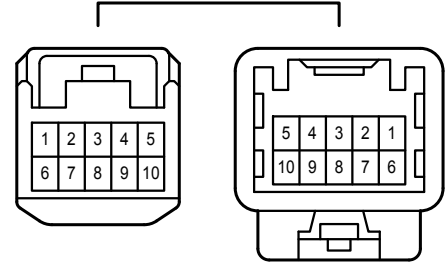

Double Locking

GE2
White

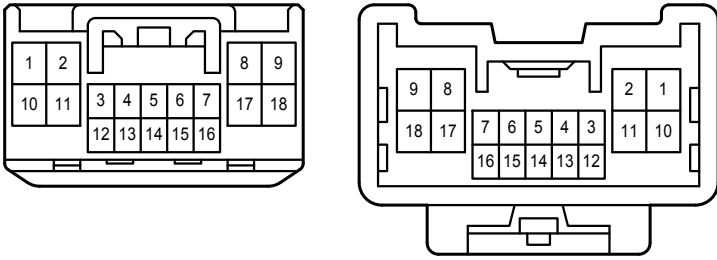

GE3
White

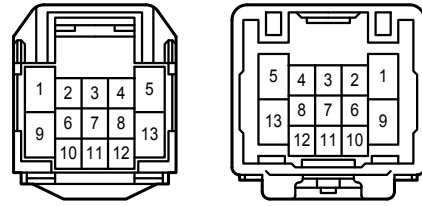

HE2
White

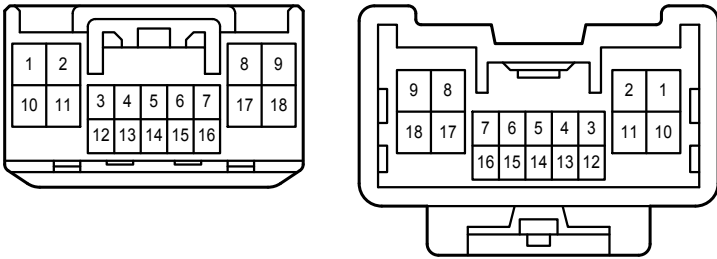

HE3
White

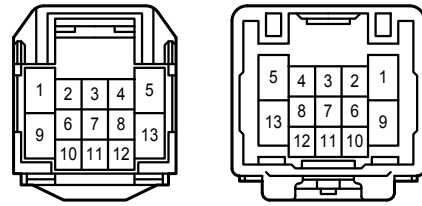

IL1
White

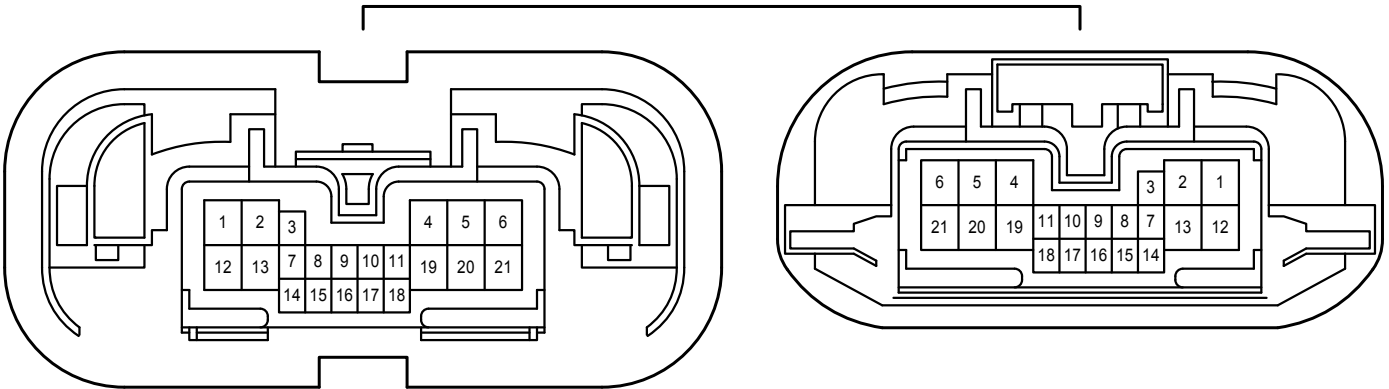

JK1
White

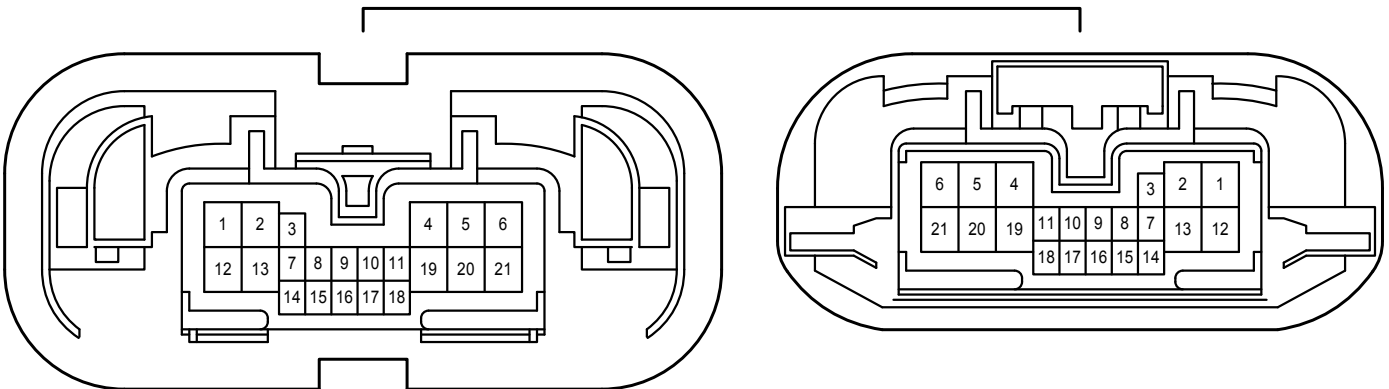

SL1
White

