

# Door Lock Control <LHD>

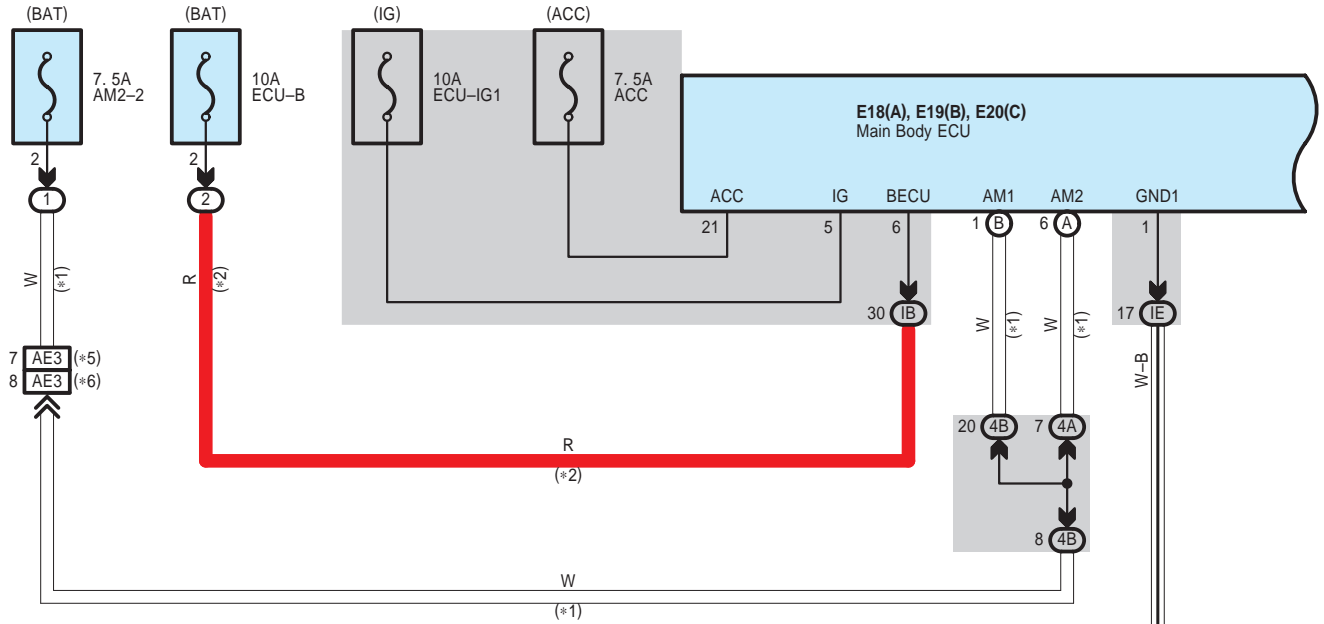

- \* 1 : w/ Entry & Start System
- \* 2 : w/o Entry & Start System
- \* 3 : Before Aug. 2008 Production Except Europe,  
Before Dec. 2008 Production Europe
- \* 4 : From Aug. 2008 Production Except Europe,  
From Dec. 2008 Production Europe
- \* 5 : Before Dec. 2008 Production Europe
- \* 6 : From Dec. 2008 Production Europe

Door Lock Control <LHD>

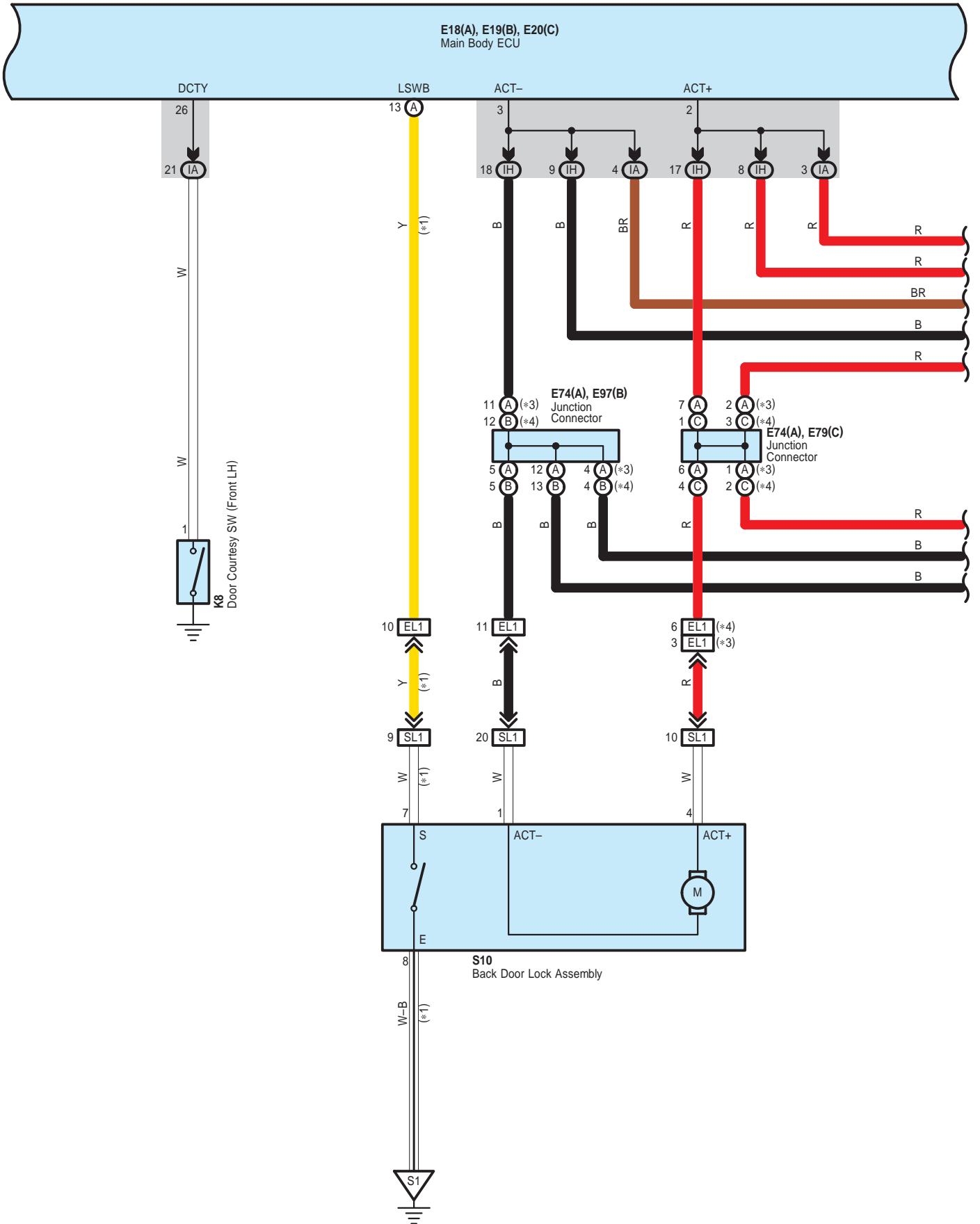

Door Lock Control <LHD>

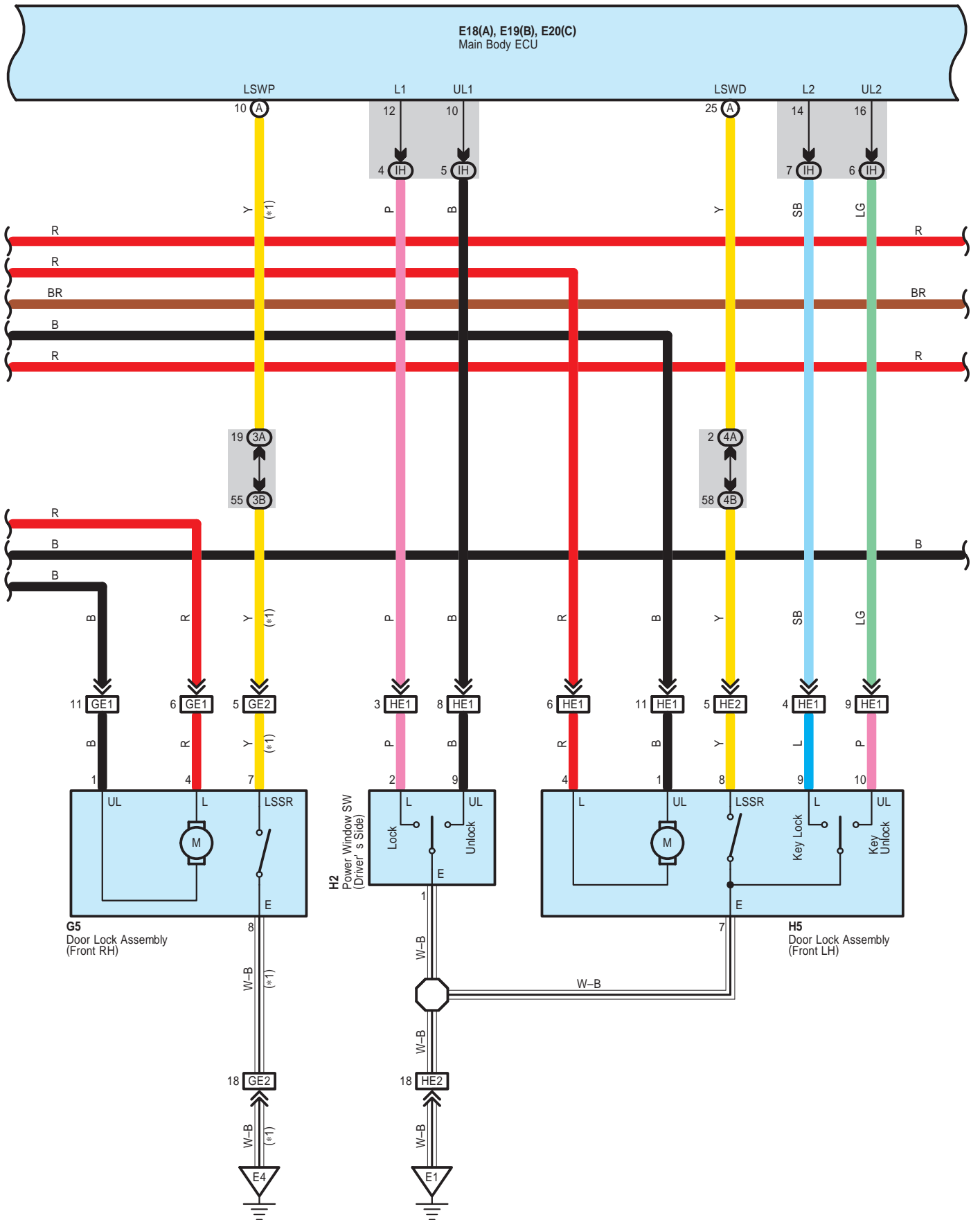

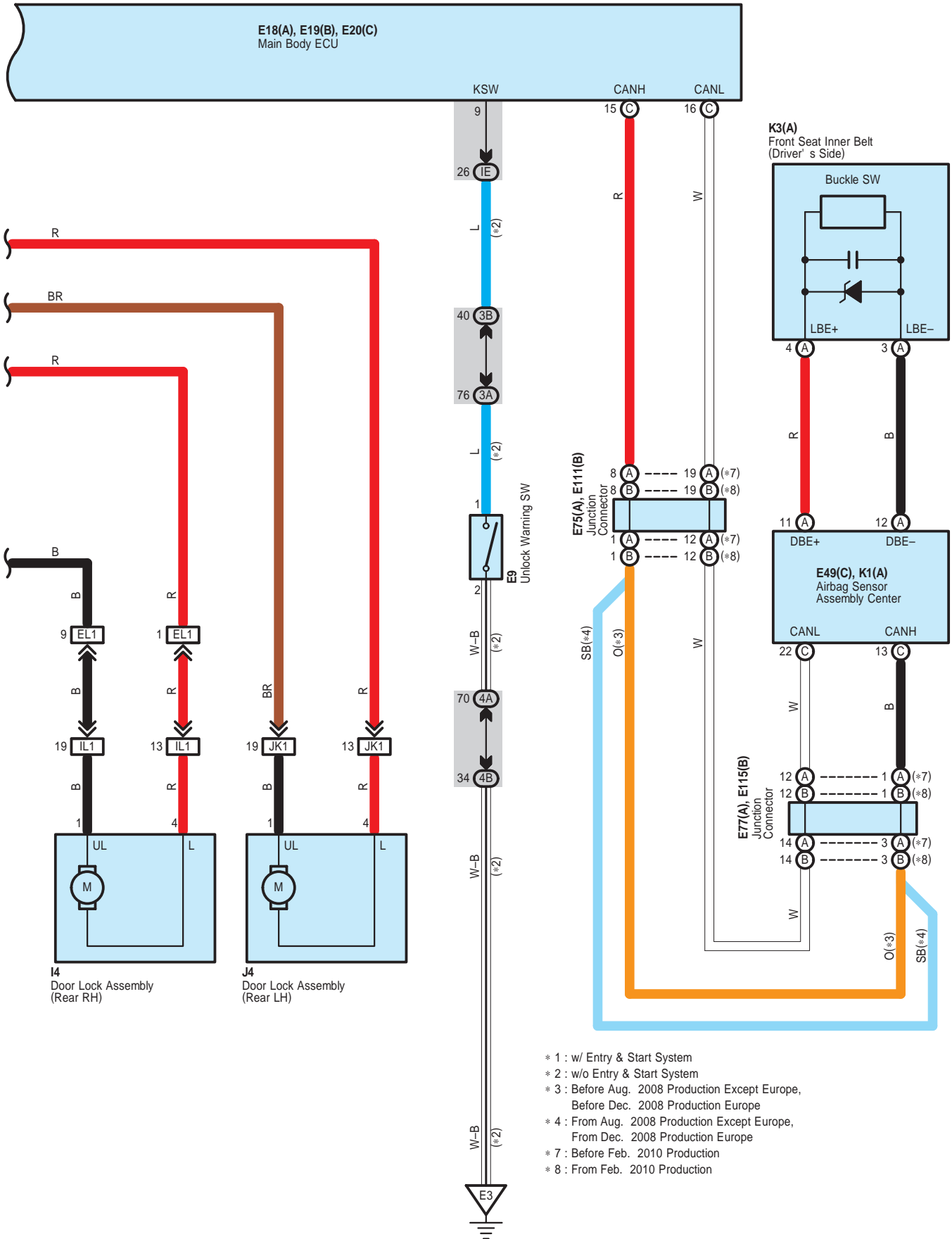

- \* 1 : w/ Entry & Start System
- \* 2 : w/o Entry & Start System
- \* 3 : Before Aug. 2008 Production Except Europe,  
Before Dec. 2008 Production Europe
- \* 4 : From Aug. 2008 Production Except Europe,  
From Dec. 2008 Production Europe
- \* 7 : Before Feb. 2010 Production
- \* 8 : From Feb. 2010 Production

Door Lock Control <LHD>

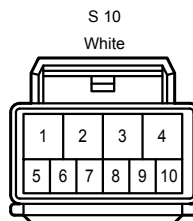
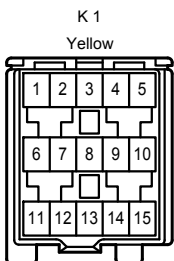
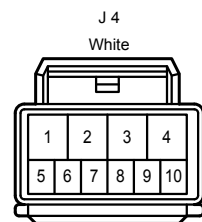
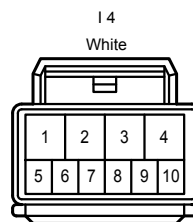
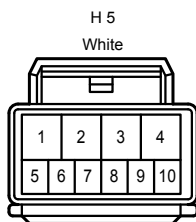
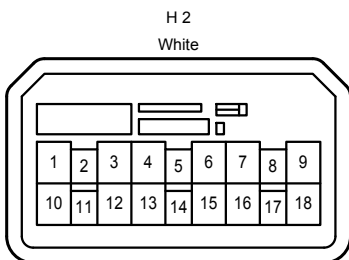
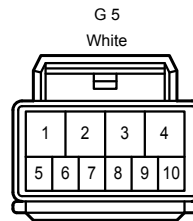
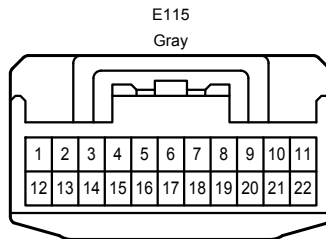
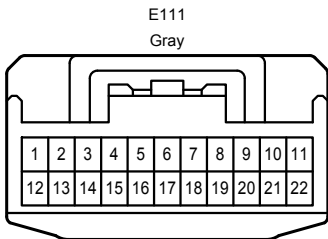
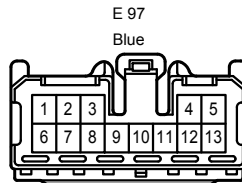
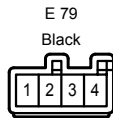
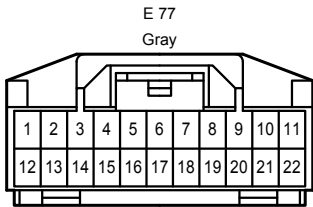
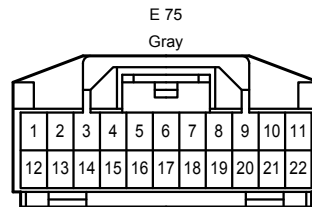
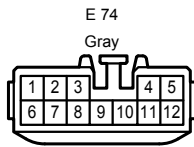
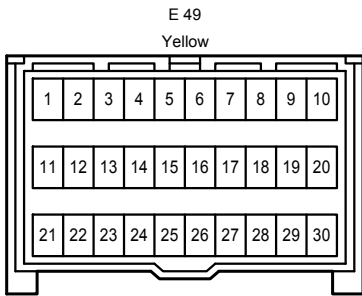
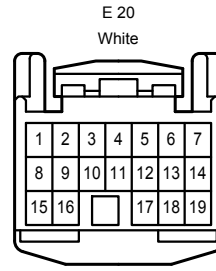
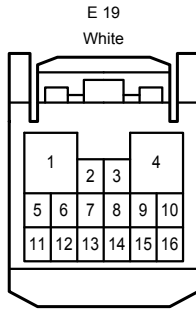
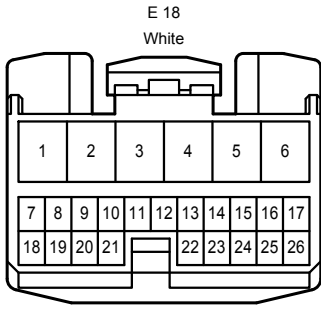

3A  
White

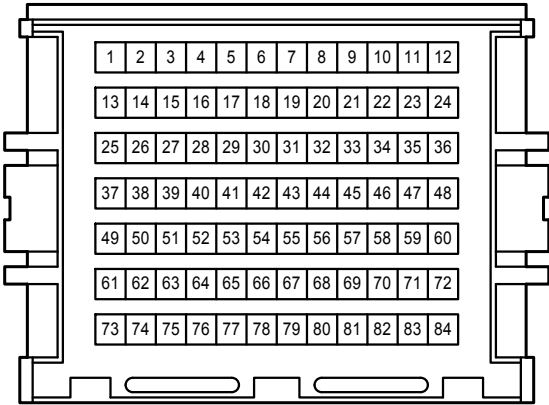

3B  
White

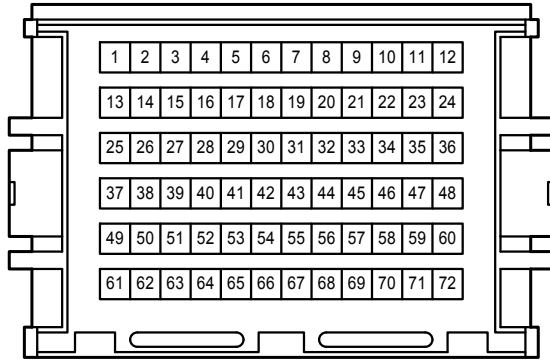

4A  
White

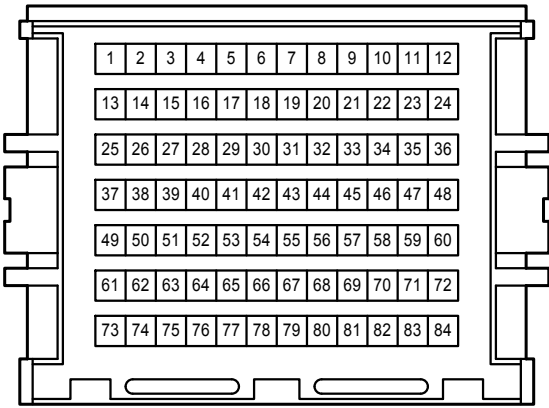

4B  
White

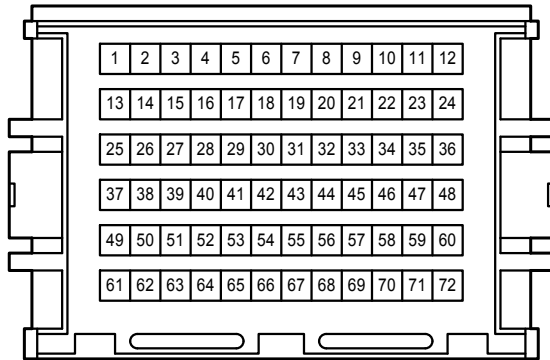

1A  
White

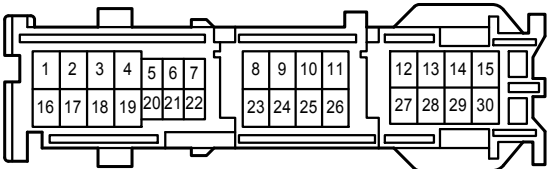

1B  
White

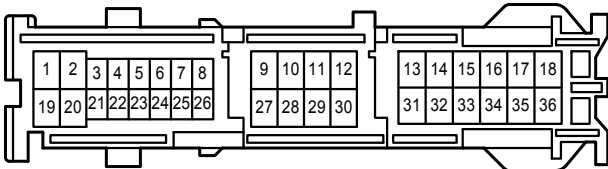

1E  
White

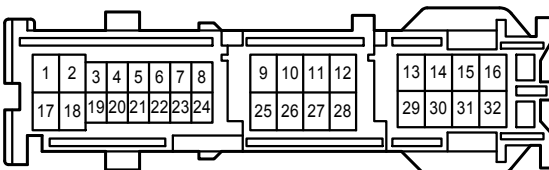

1H  
White

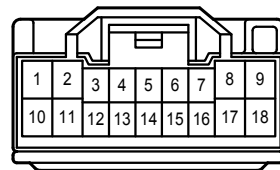

Door Lock Control <LHD>

AE3  
Black

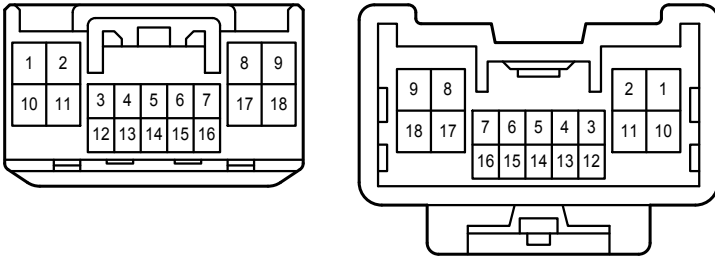

EL1  
White

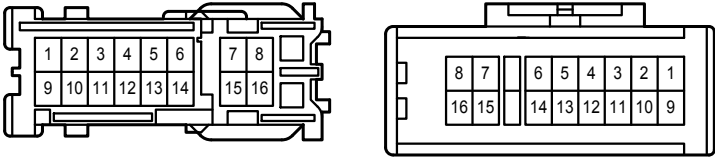

GE1  
White

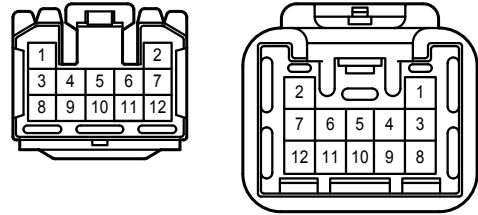

GE2  
White

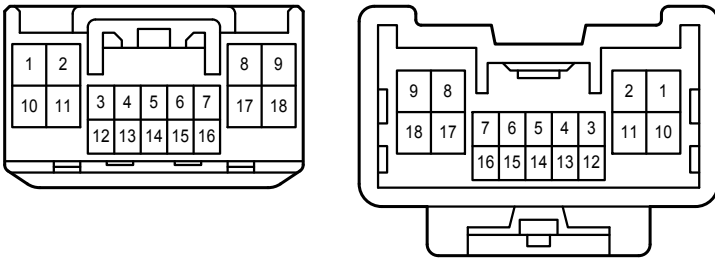

HE1  
White

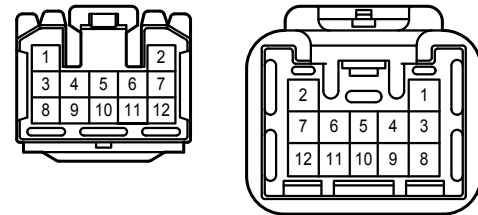

HE2  
White

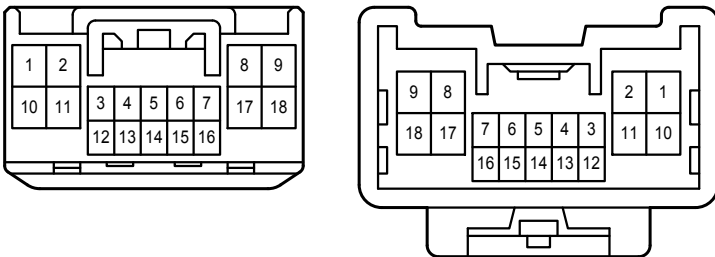

Door Lock Control <LHD>

IL1  
White

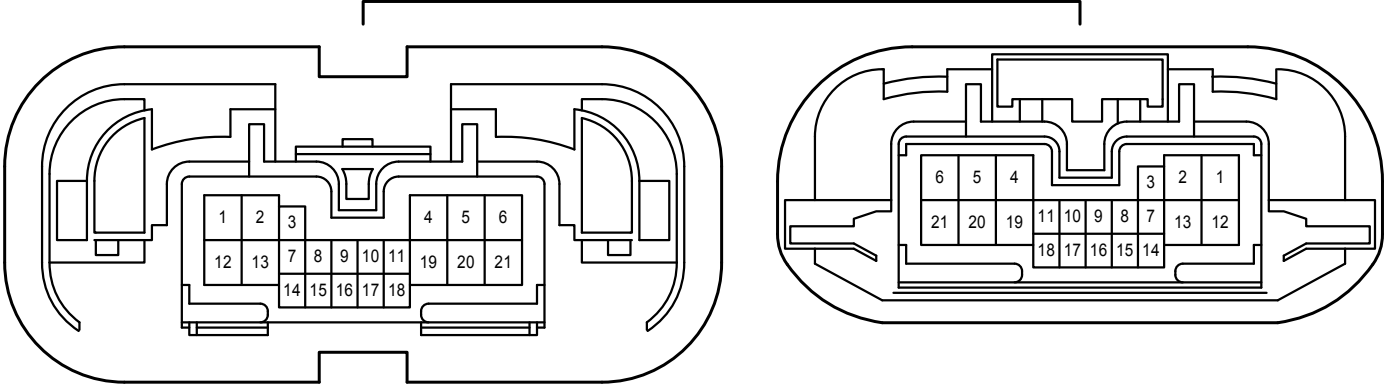

JK1  
White

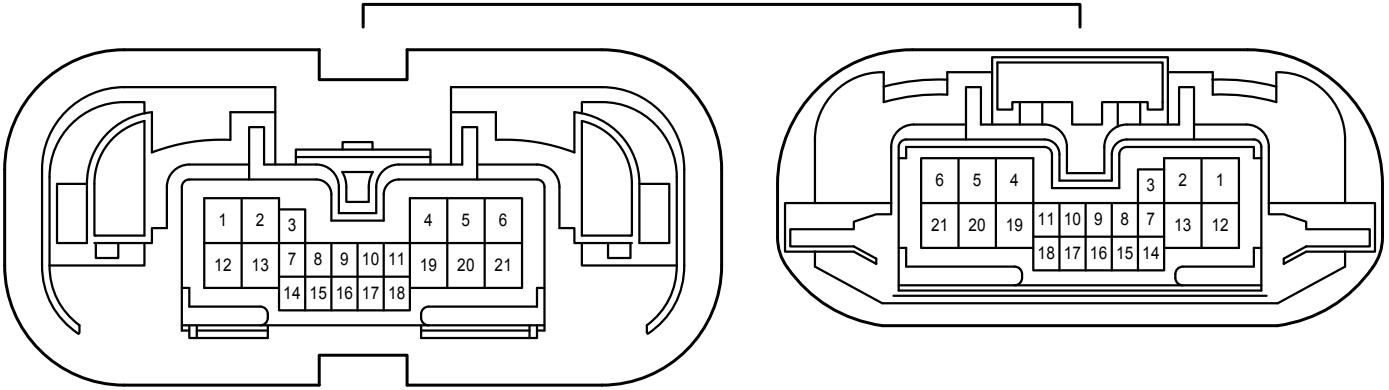

SL1  
White

