

Door Lock Control <RHD>

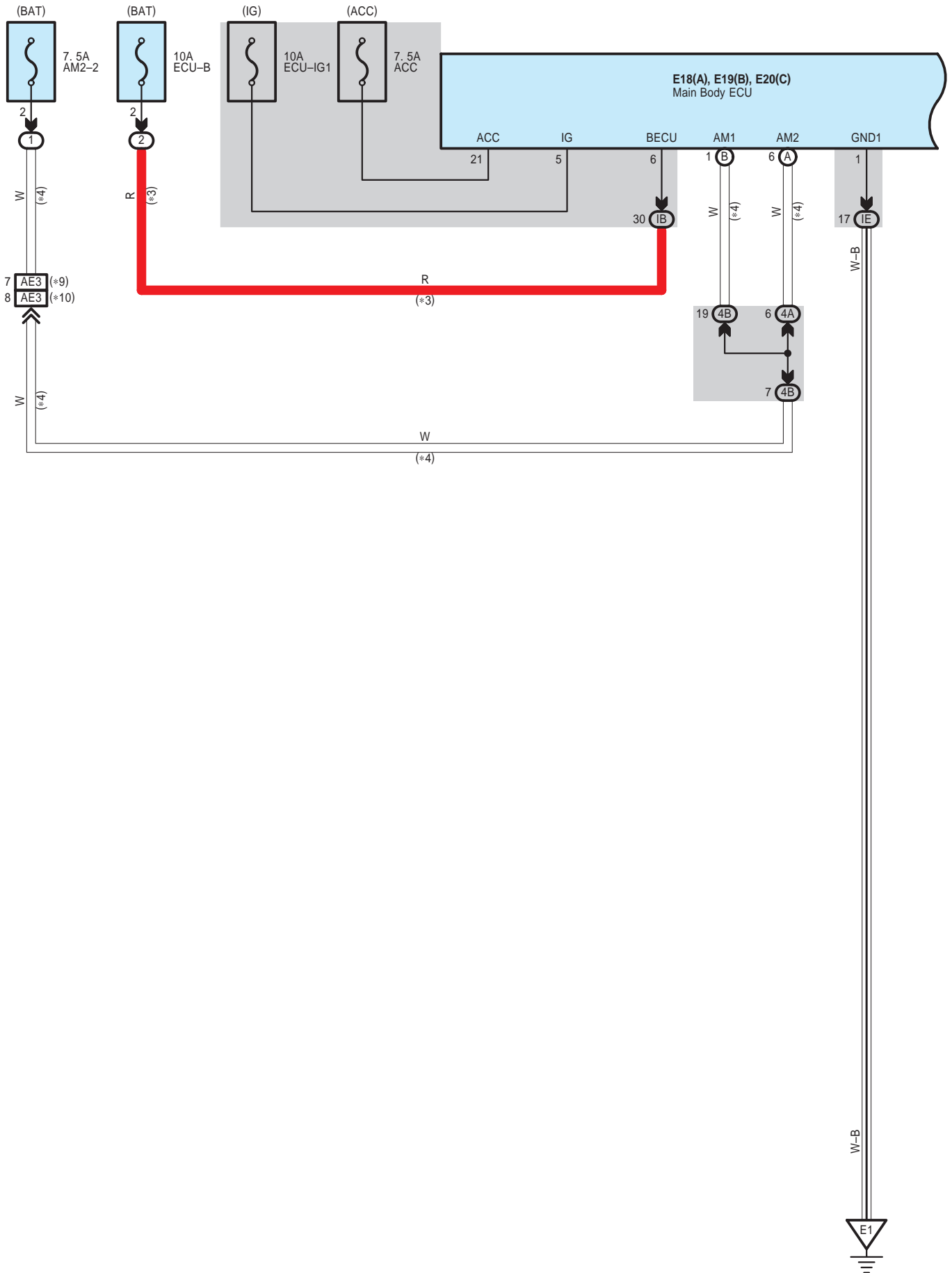

Door Lock Control <RHD>

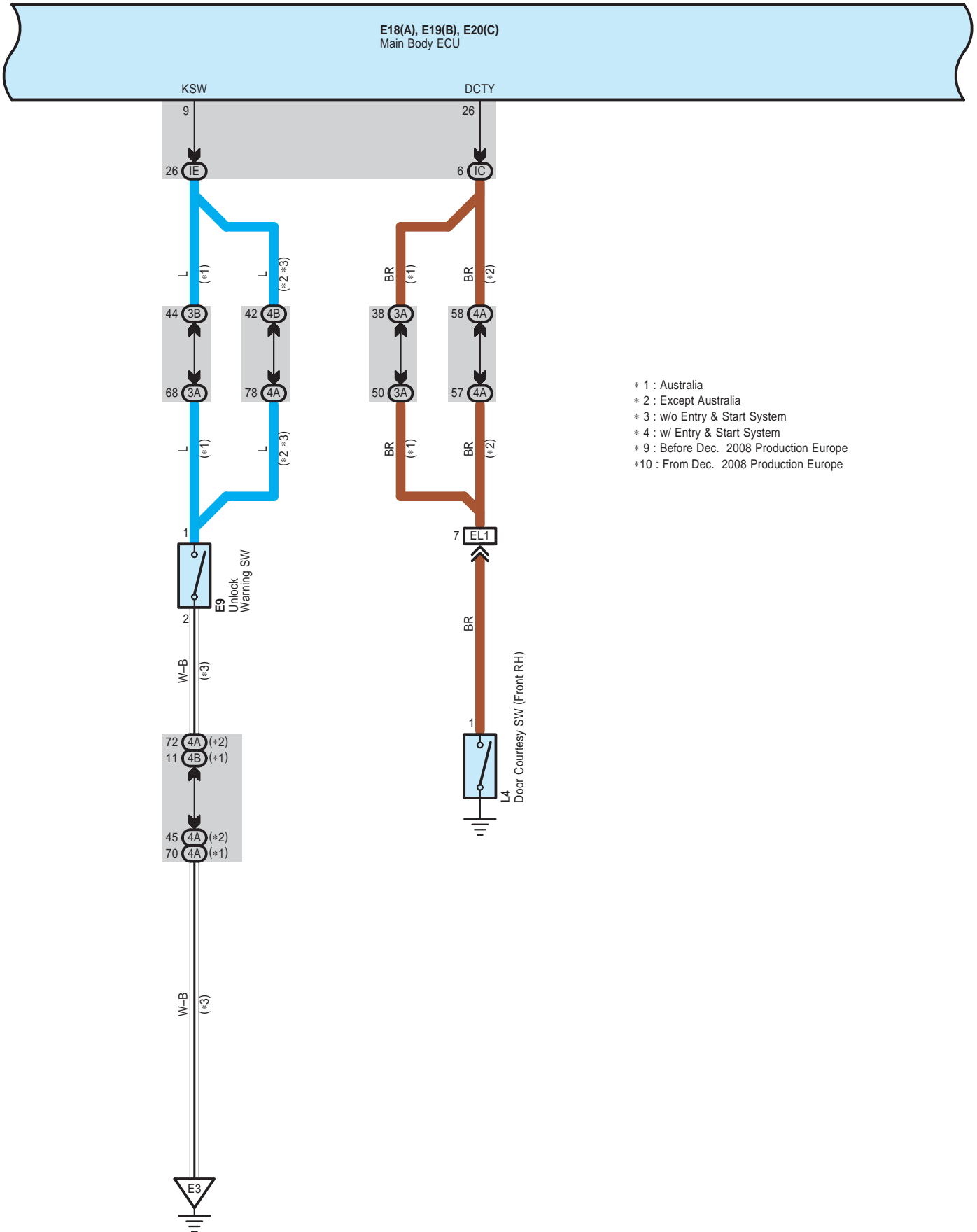

- * 1 : Australia
- * 2 : Except Australia
- * 3 : w/o Entry & Start System
- * 4 : w/ Entry & Start System
- * 9 : Before Dec. 2008 Production Europe
- *10 : From Dec. 2008 Production Europe

Door Lock Control <RHD>

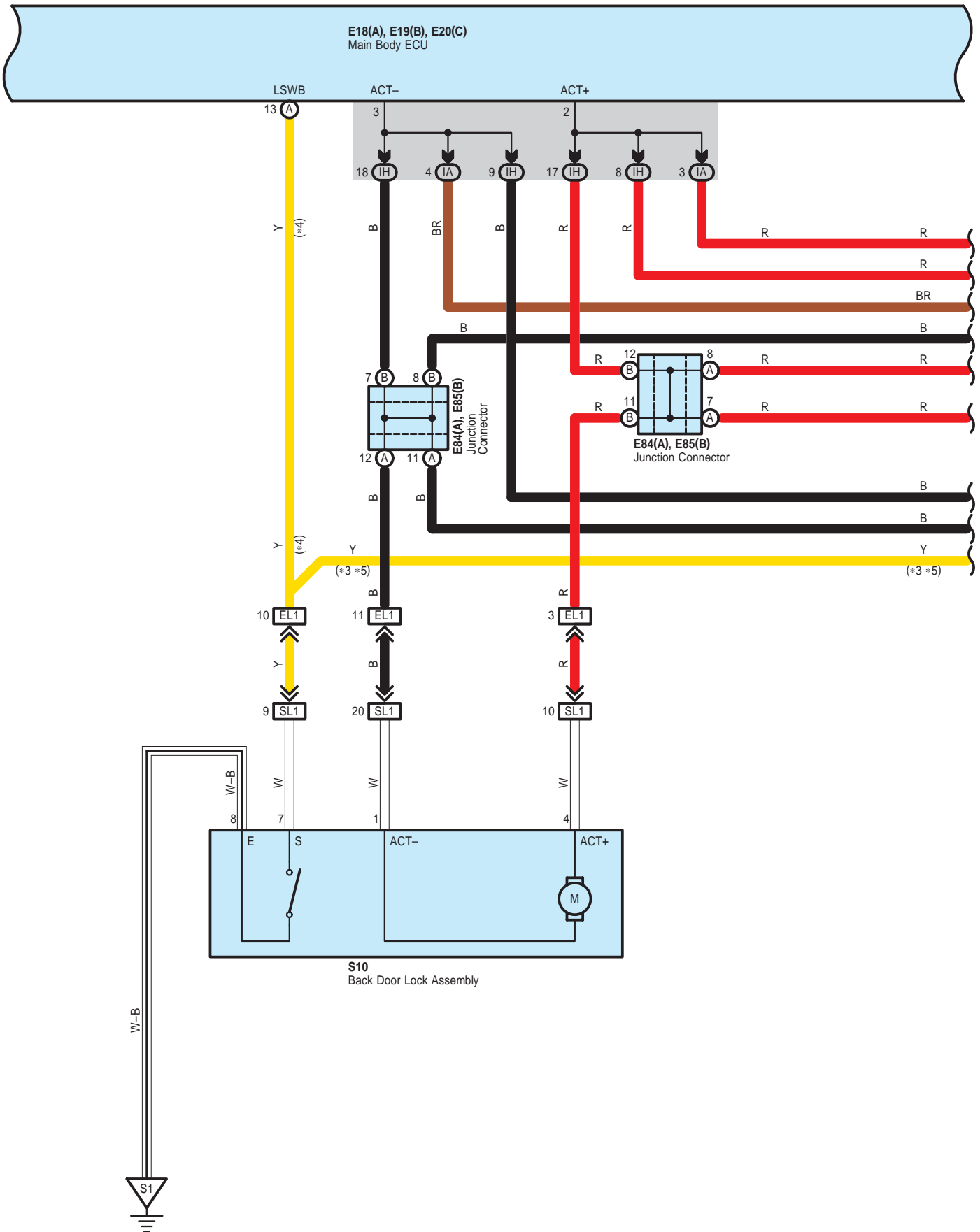

Door Lock Control <RHD>

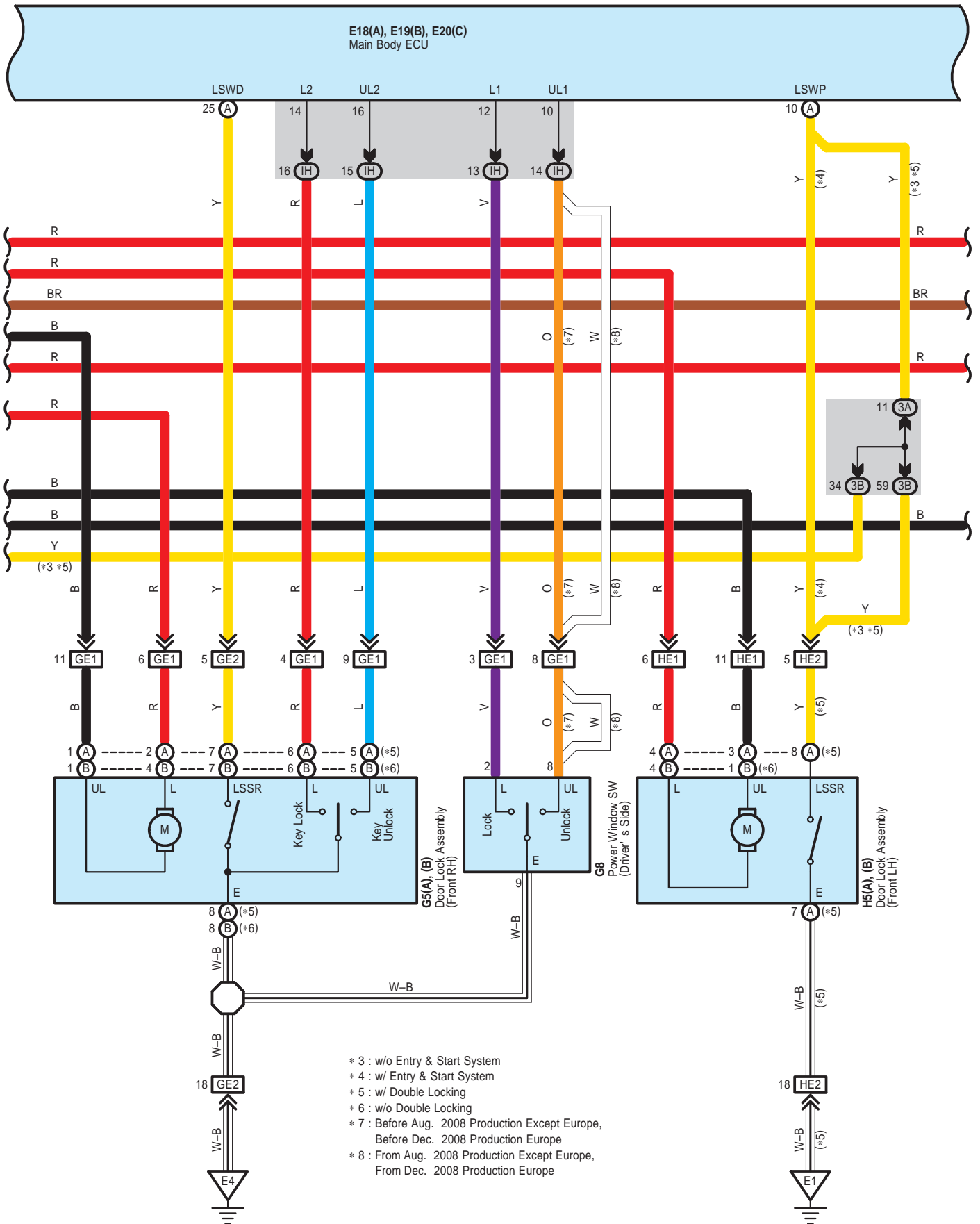

Door Lock Control <RHD>

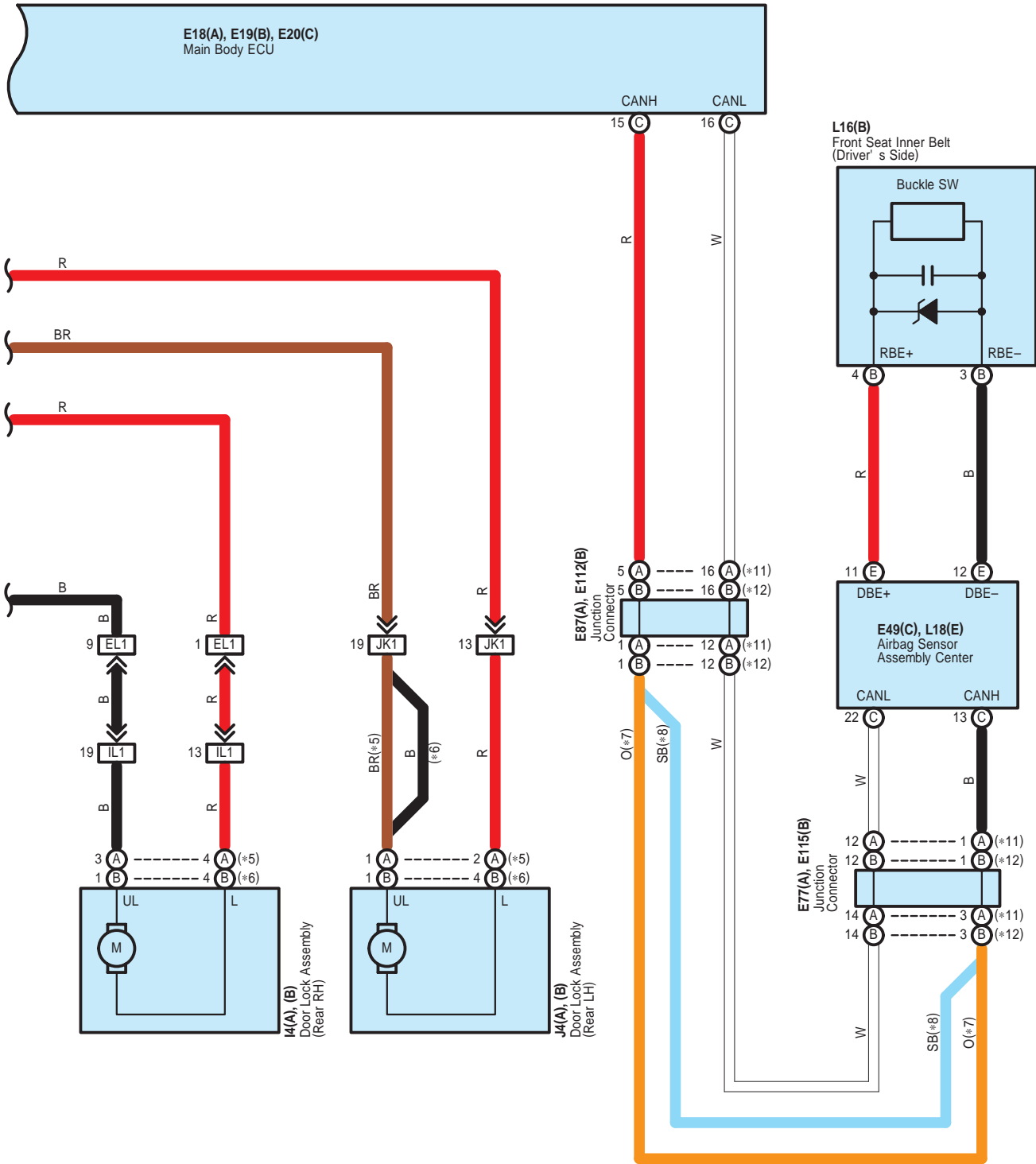

- * 5 : w/ Double Locking
- * 6 : w/o Double Locking
- * 7 : Before Aug. 2008 Production Except Europe,
Before Dec. 2008 Production Europe
- * 8 : From Aug. 2008 Production Except Europe,
From Dec. 2008 Production Europe
- * 11 : Before Feb. 2010 Production
- * 12 : From Feb. 2010 Production

Door Lock Control <RHD>

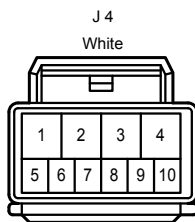
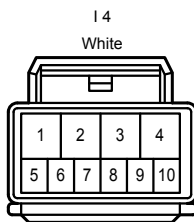
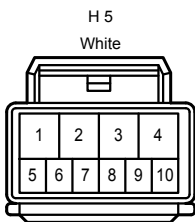
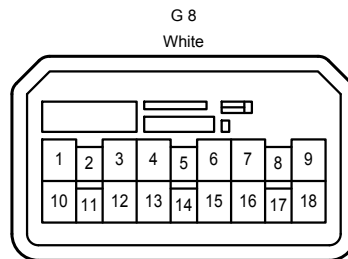
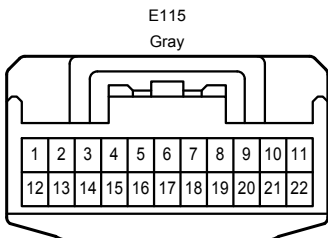
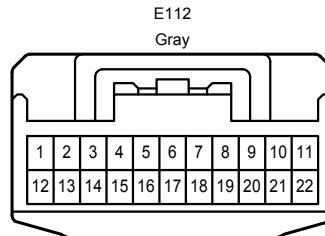
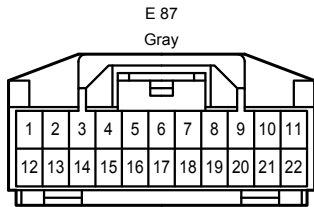
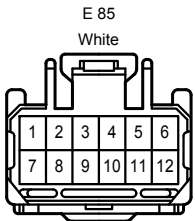
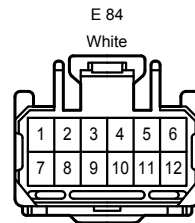
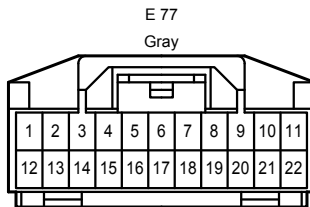
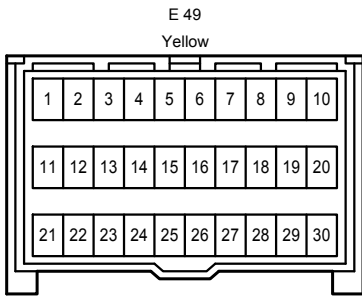
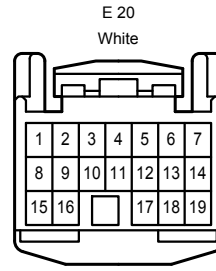
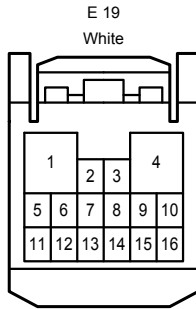
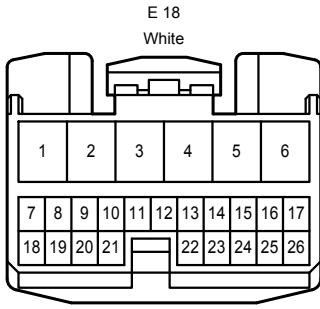

Door Lock Control <RHD>

L 18
Yellow

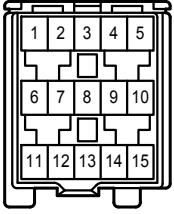

S 10
White

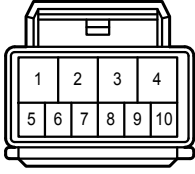

3A
White

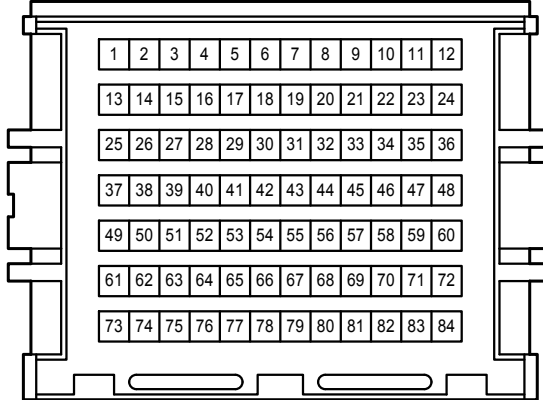

3B
White

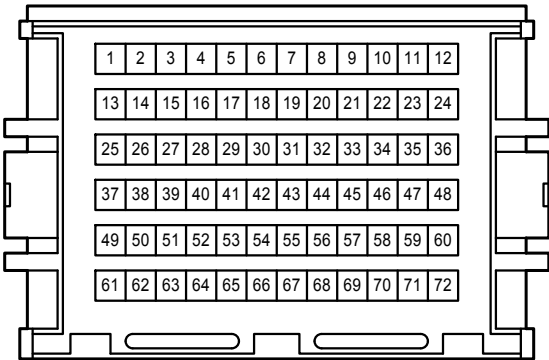

4A
White

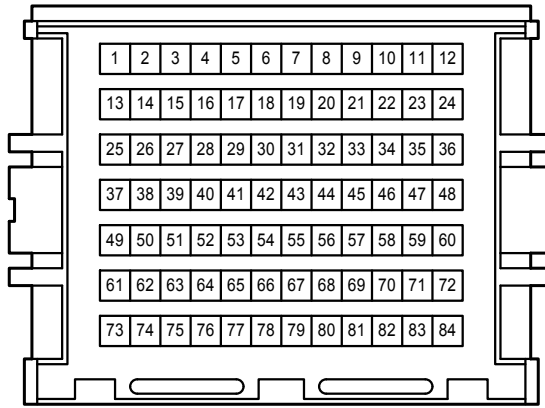

4B
White

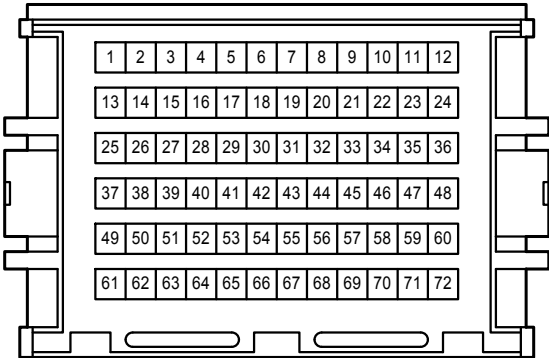

1A
White

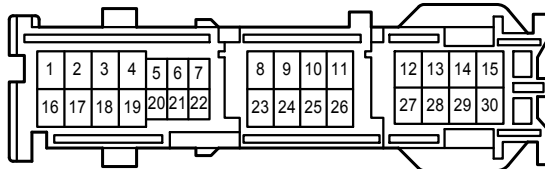

1B
White

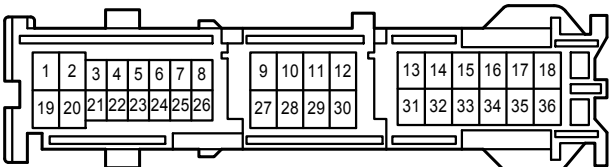

1C
White

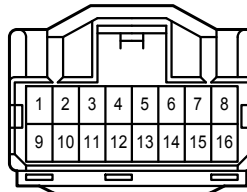

Door Lock Control <RHD>

IE
White

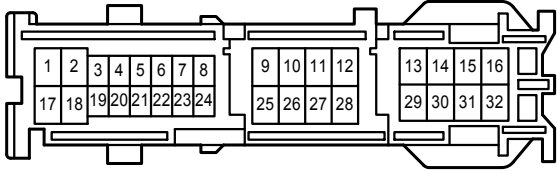

IH
White

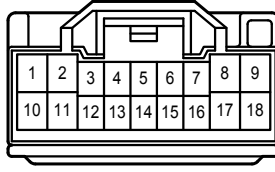

AE3
Black

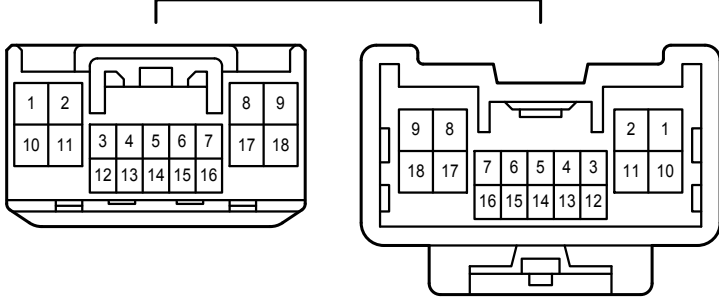

EL1
White

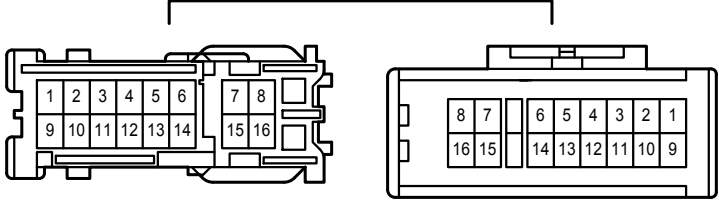

GE1
White

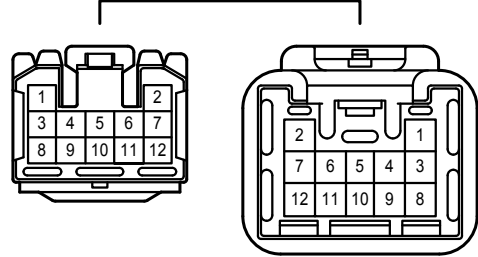

GE2
White

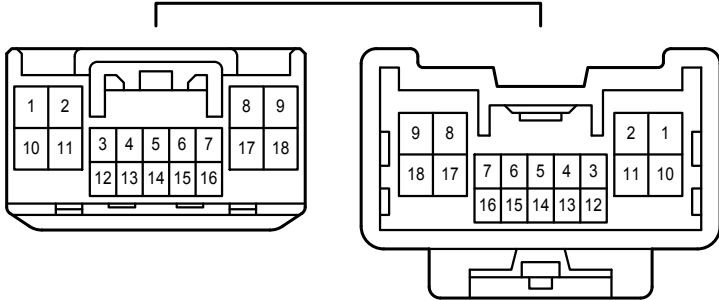

HE1
White

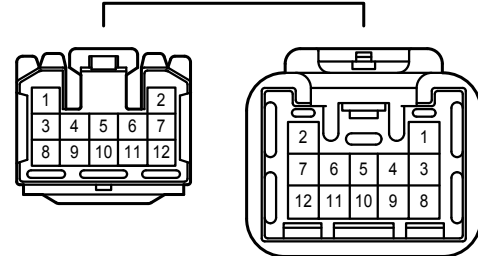

HE2
White

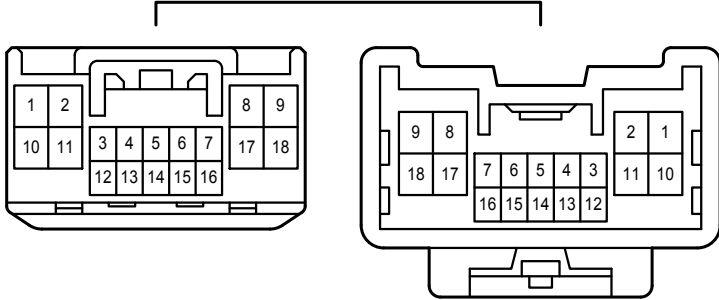

Door Lock Control <RHD>

IL1
White

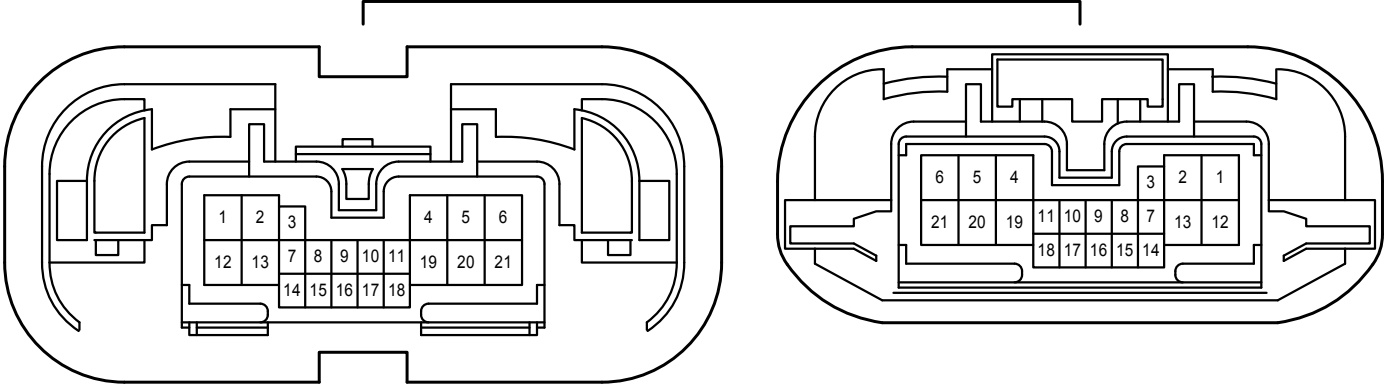

JK1
White

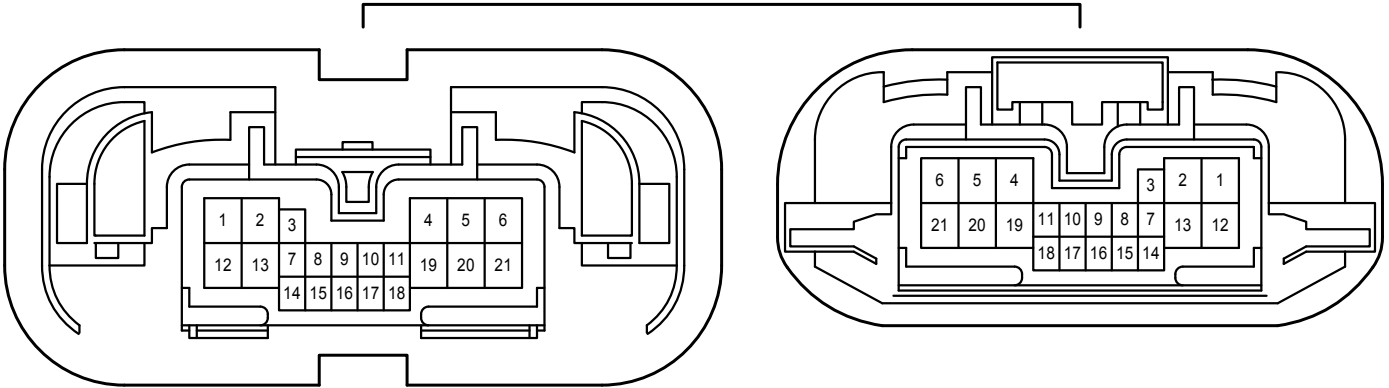

SL1
White

