

Front Wiper and Washer <w/ Auto Wiper System>

- \* 1 : Before Dec. 2008 Production
- \* 2 : From Dec. 2008 Production
- \* 3 : 3ZR-FAE
- \* 4 : Except 3ZR-FAE
- \* 5 : w/ VSC
- \* 6 : w/o VSC

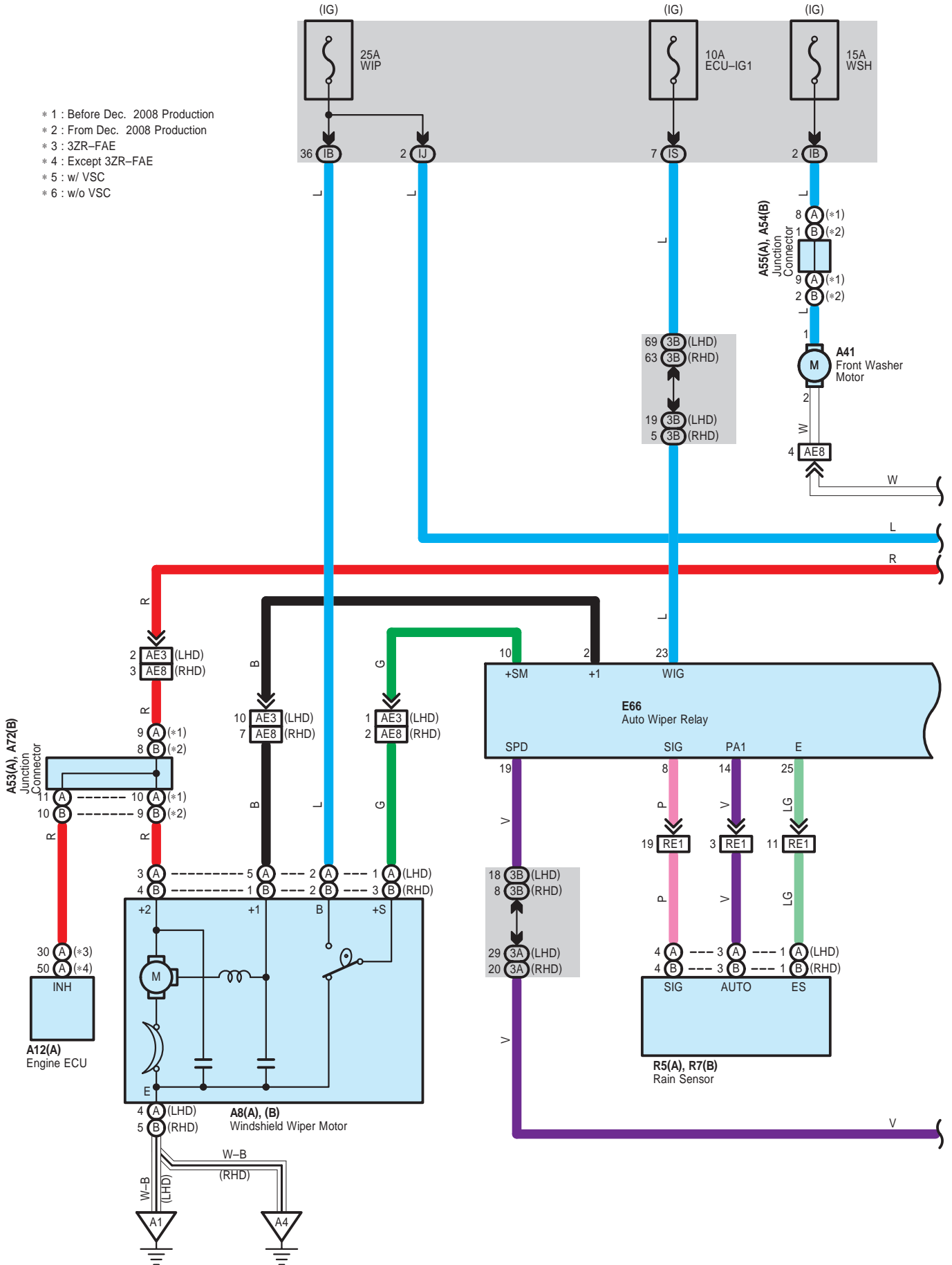

Front Wiper and Washer <w/ Auto Wiper System>

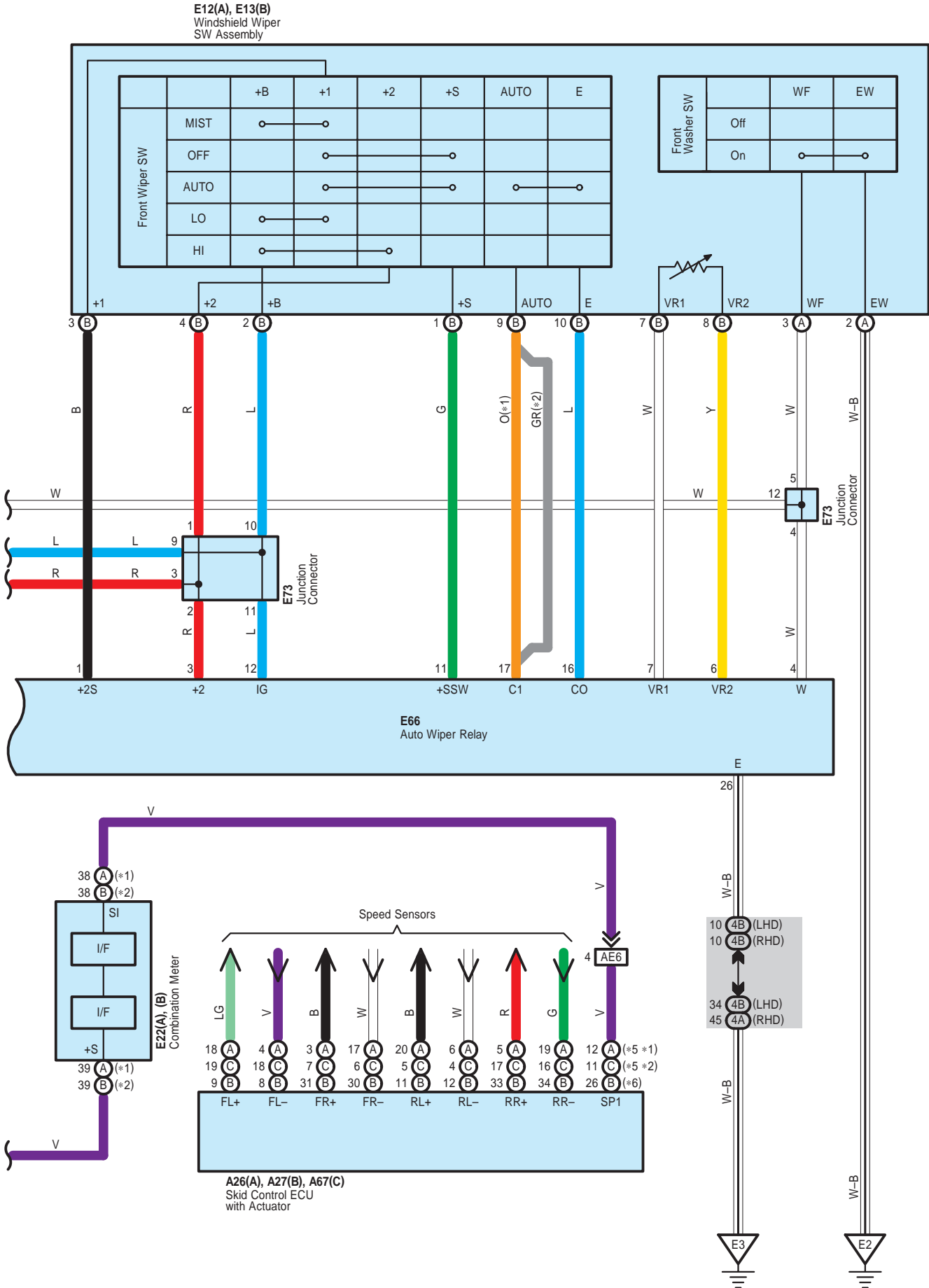

Front Wiper and Washer <w/ Auto Wiper System>

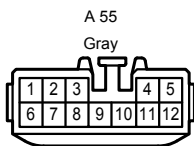
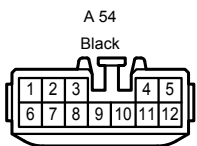
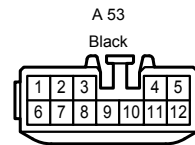
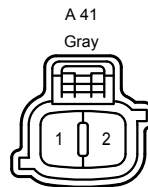
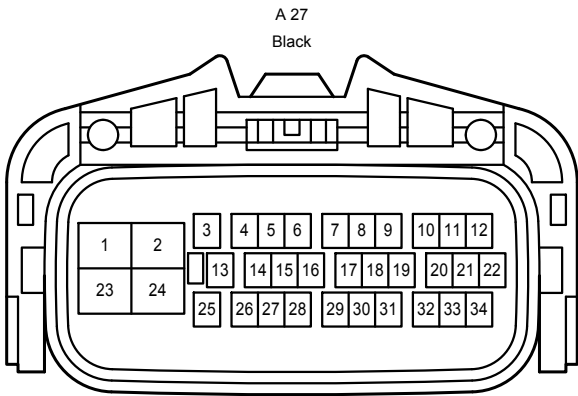
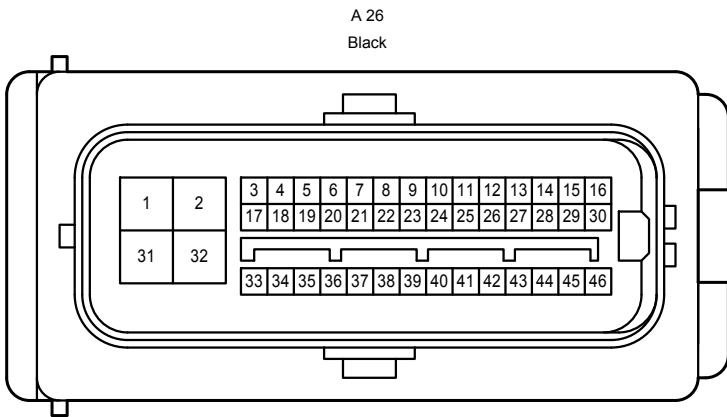
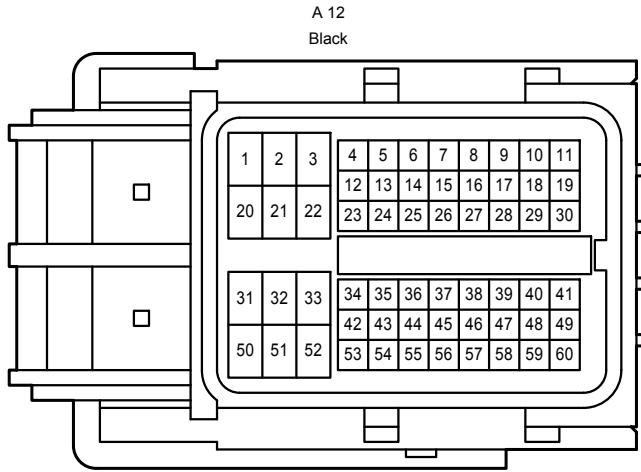
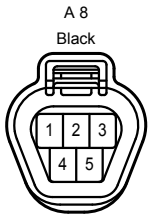

Front Wiper and Washer <w/ Auto Wiper System>

A 67  
Black

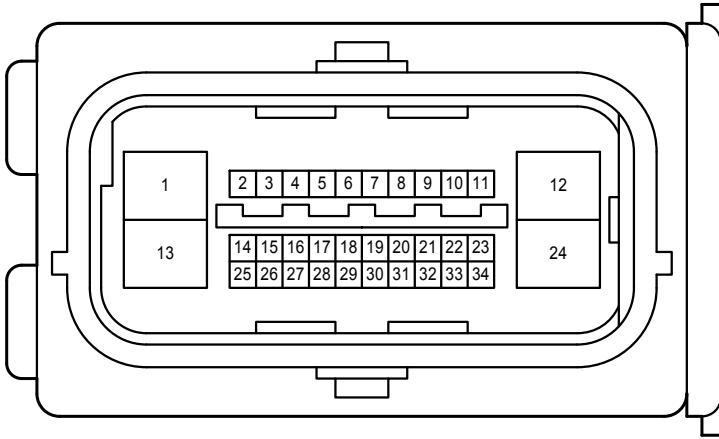

A 72  
Gray

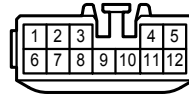

E 12  
White

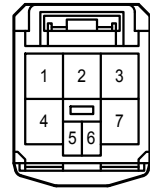

E 13  
White



E 22  
White

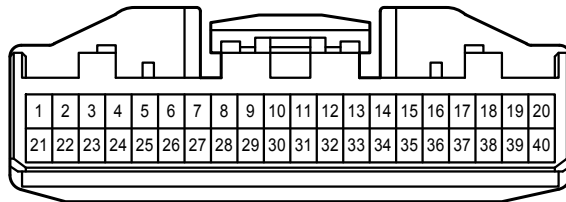

E 66  
White

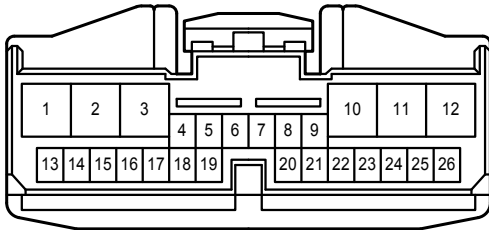

E 73  
Black

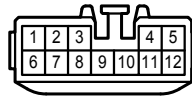

R 5  
Black

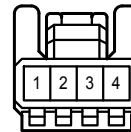

R 7  
Black

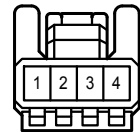

3A  
White

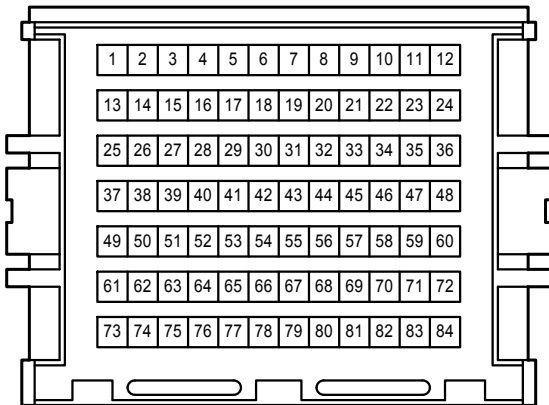

3B  
White

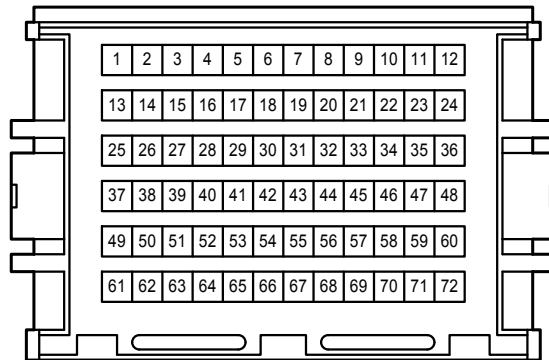

Front Wiper and Washer <w/ Auto Wiper System>

4A  
White

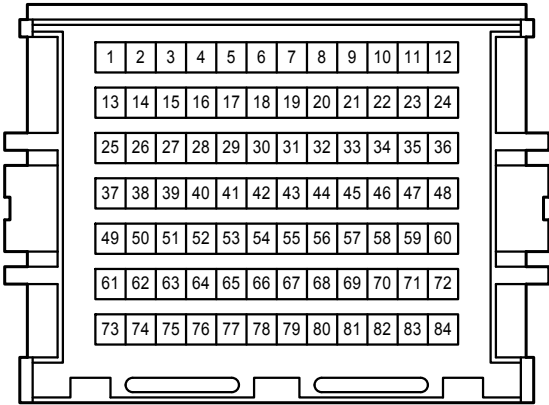

4B  
White

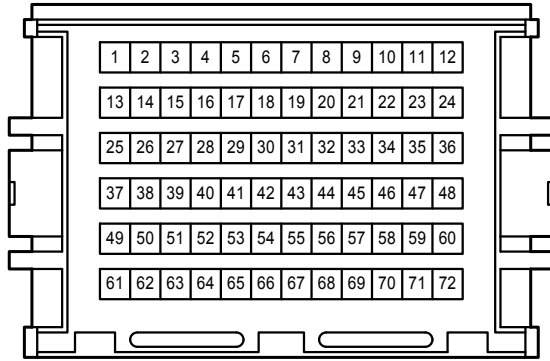

1B  
White

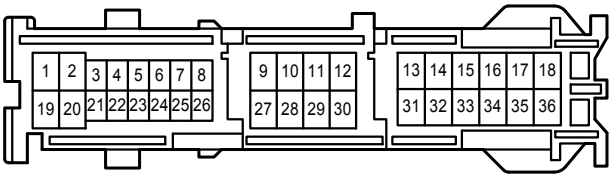

1J  
White

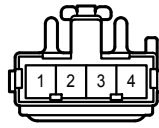

1S  
White

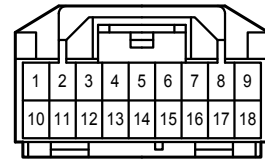

AE3  
Black

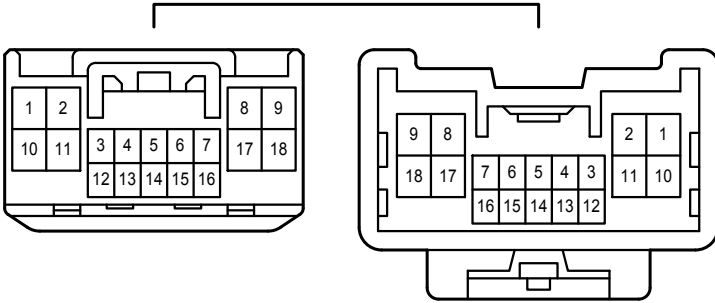

AE6  
White

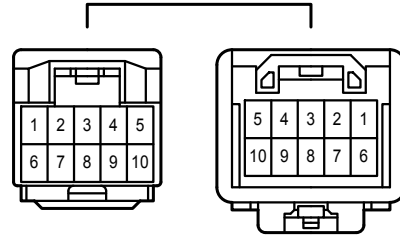

AE8  
White

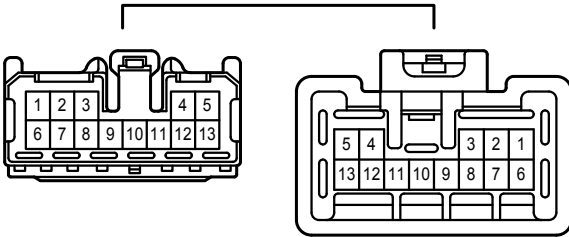

RE1  
White

