

Rear Fog Light

- * 1 : Long Body
- * 2 : Short Body
- * 3 : LH Turn Lever Type
- * 4 : RH Turn Lever Type
- * 5 : Before Aug. 2008 Production Except Europe, Before Dec. 2008 Production Europe
- * 6 : From Aug. 2008 Production Except Europe, From Dec. 2008 Production Europe
- * 7 : Before Feb. 2010 Production
- * 8 : From Feb. 2010 Production

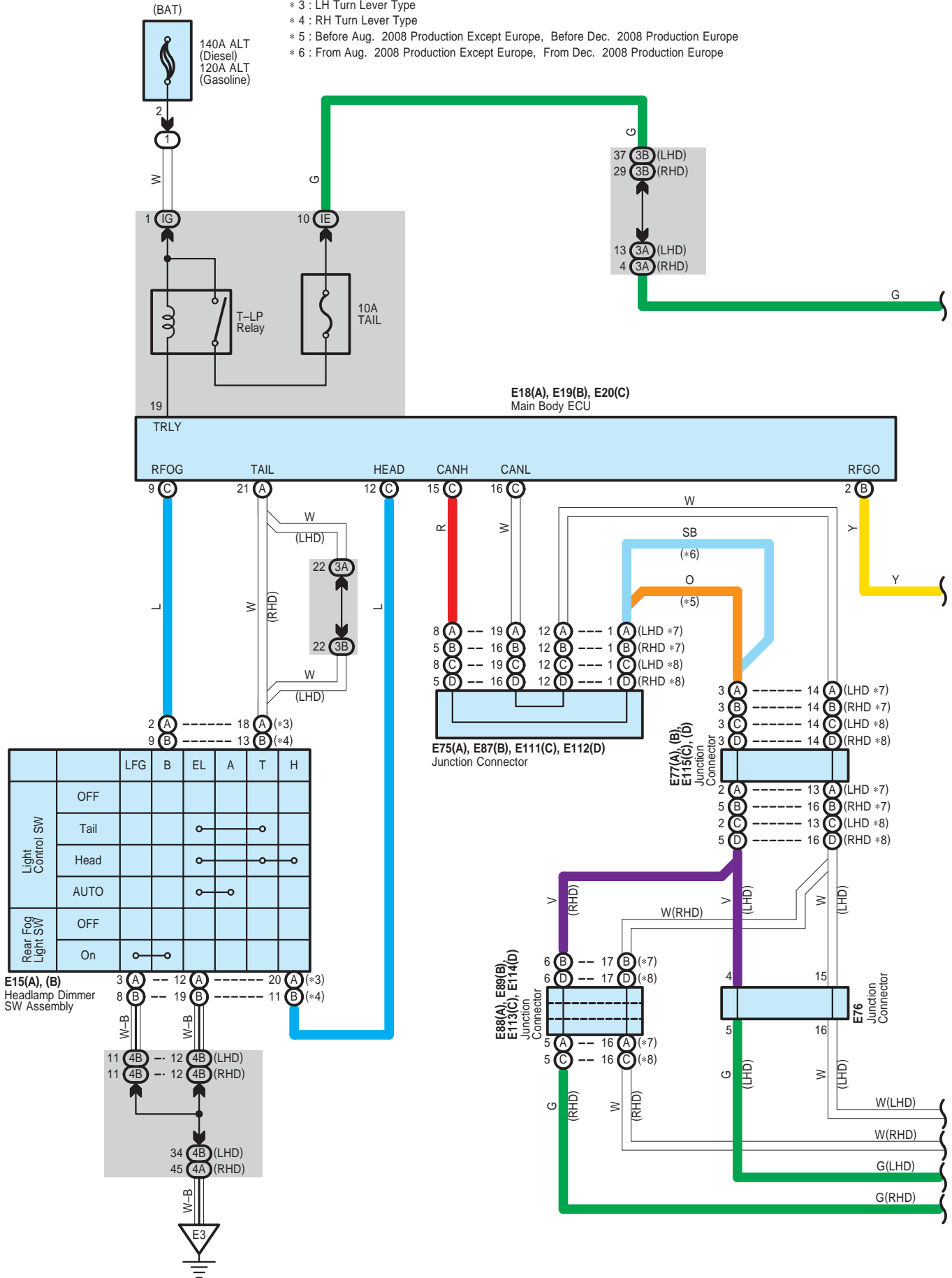

Rear Fog Light

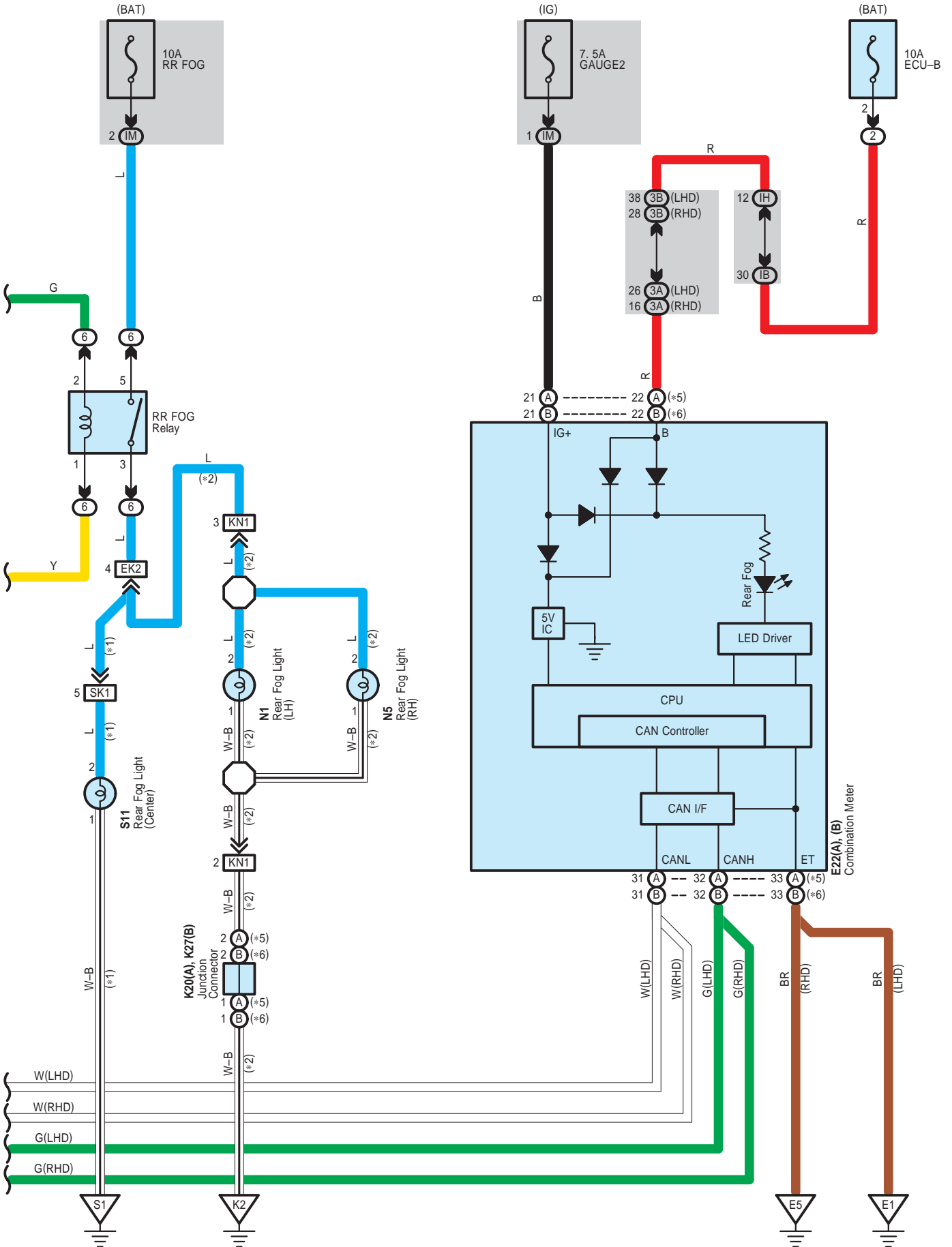

Rear Fog Light

E 15
White

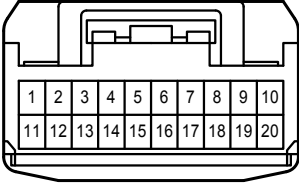

E 18
White

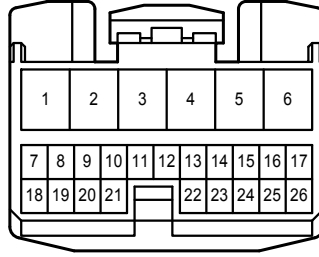

E 19
White

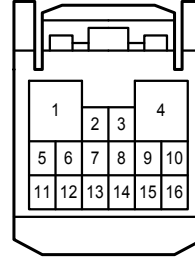

E 20
White

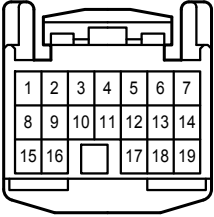

E 22
White

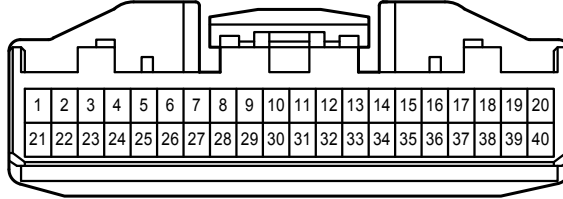

E 75
Gray

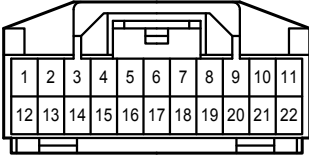

E 76
Black

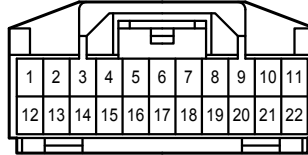

E 77
Gray

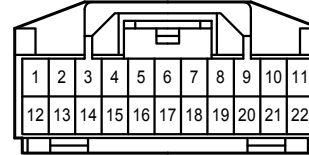

E 87
Gray

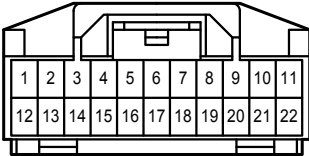

E 88
Blue

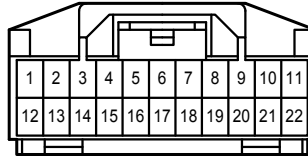

E 89
Blue

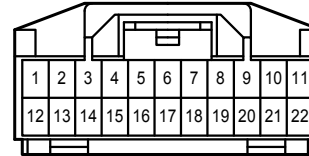

E111
Gray

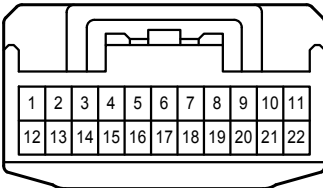

E112
Gray

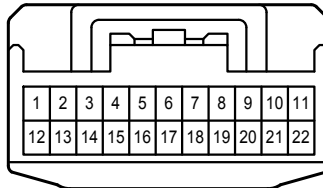

E113
Black

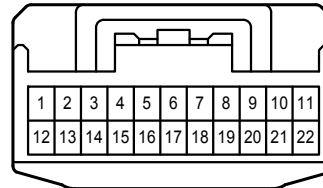

E114
Black

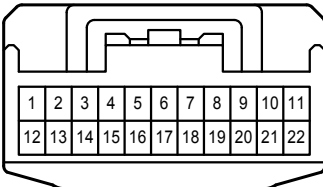

E115
Gray

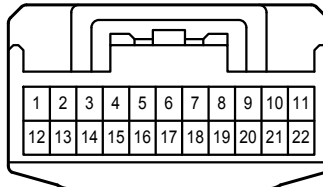

K 20
Black

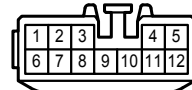

Rear Fog Light

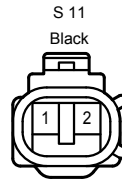
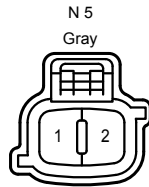
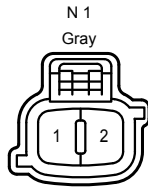
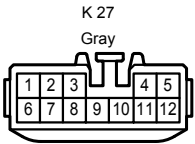

3A
White

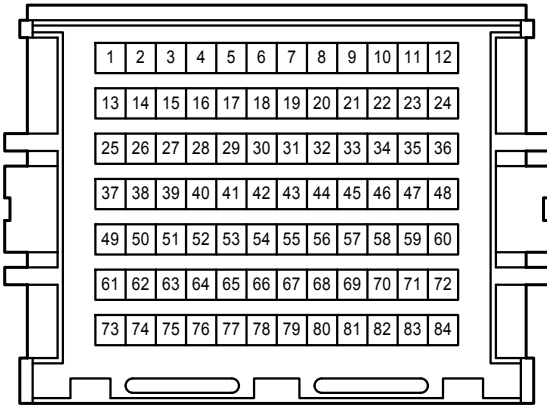

3B
White

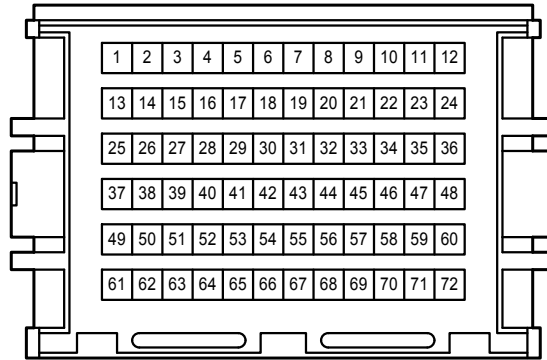

4A
White

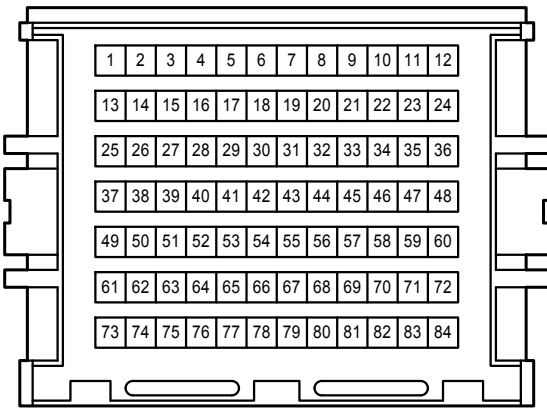

4B
White

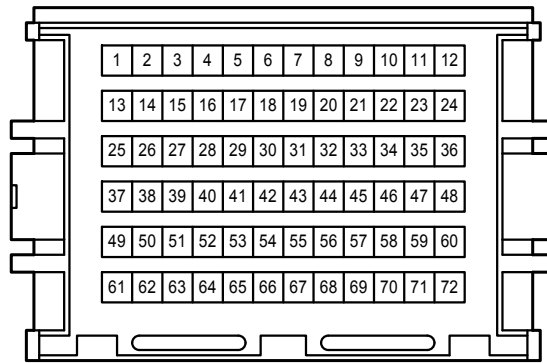

IB
White

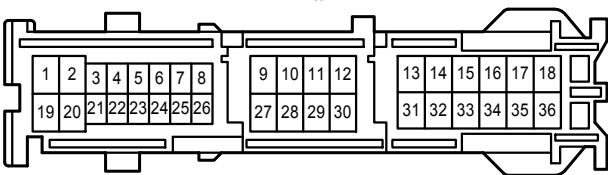

IE
White

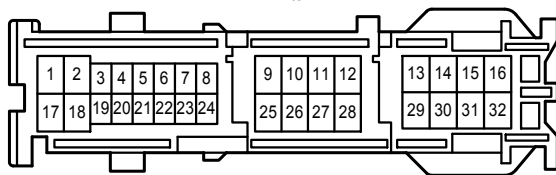

IG
White

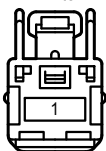

IH
White

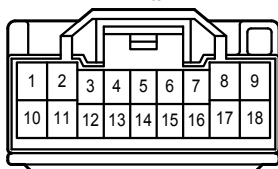

IM
White

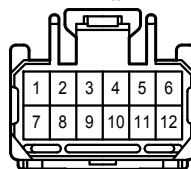

Rear Fog Light

EK2
White

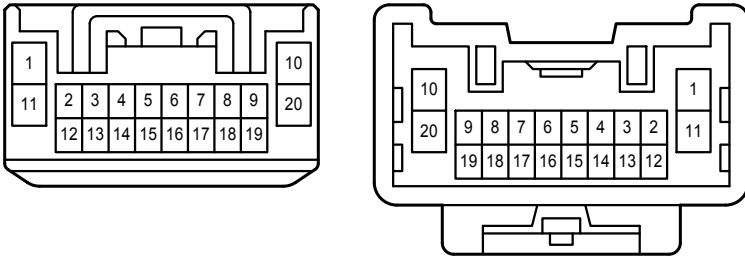

KN1
White

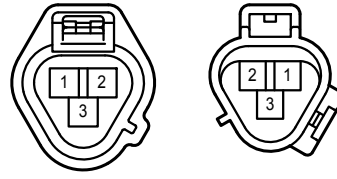

SK1
White

