

Turn Signal and Hazard Warning Light <RHD>

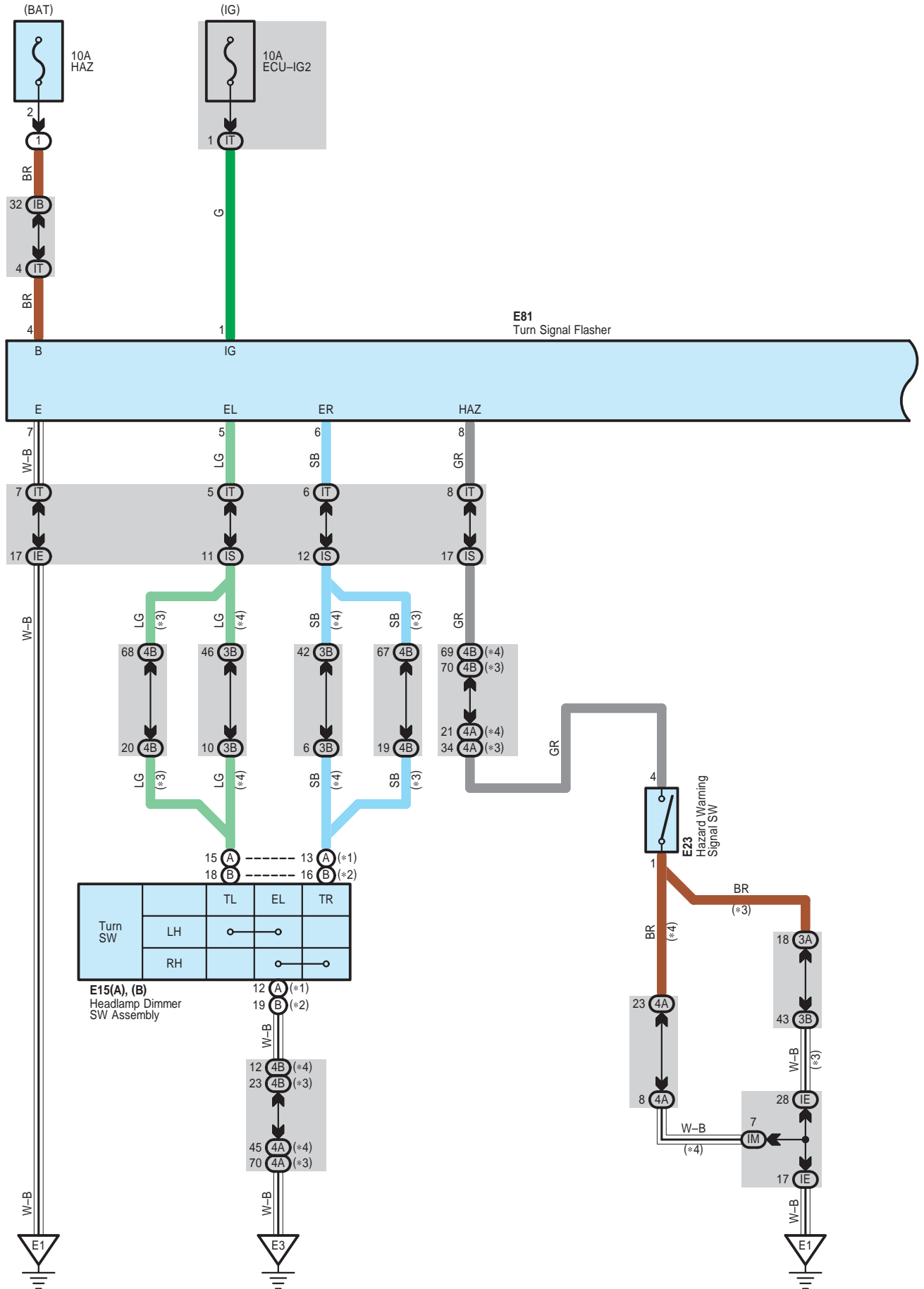

Turn Signal and Hazard Warning Light <RHD>

- * 1 : LH Turn Lever Type
- * 2 : RH Turn Lever Type
- * 3 : Australia
- * 4 : Except Australia
- * 5 : Before Aug. 2008 Production Except Europe, Before Dec. 2008 Production Europe
- * 6 : From Aug. 2008 Production Except Europe, From Dec. 2008 Production Europe
- * 7 : Outer Rear View Mirror Type
- * 8 : Front Fender Type

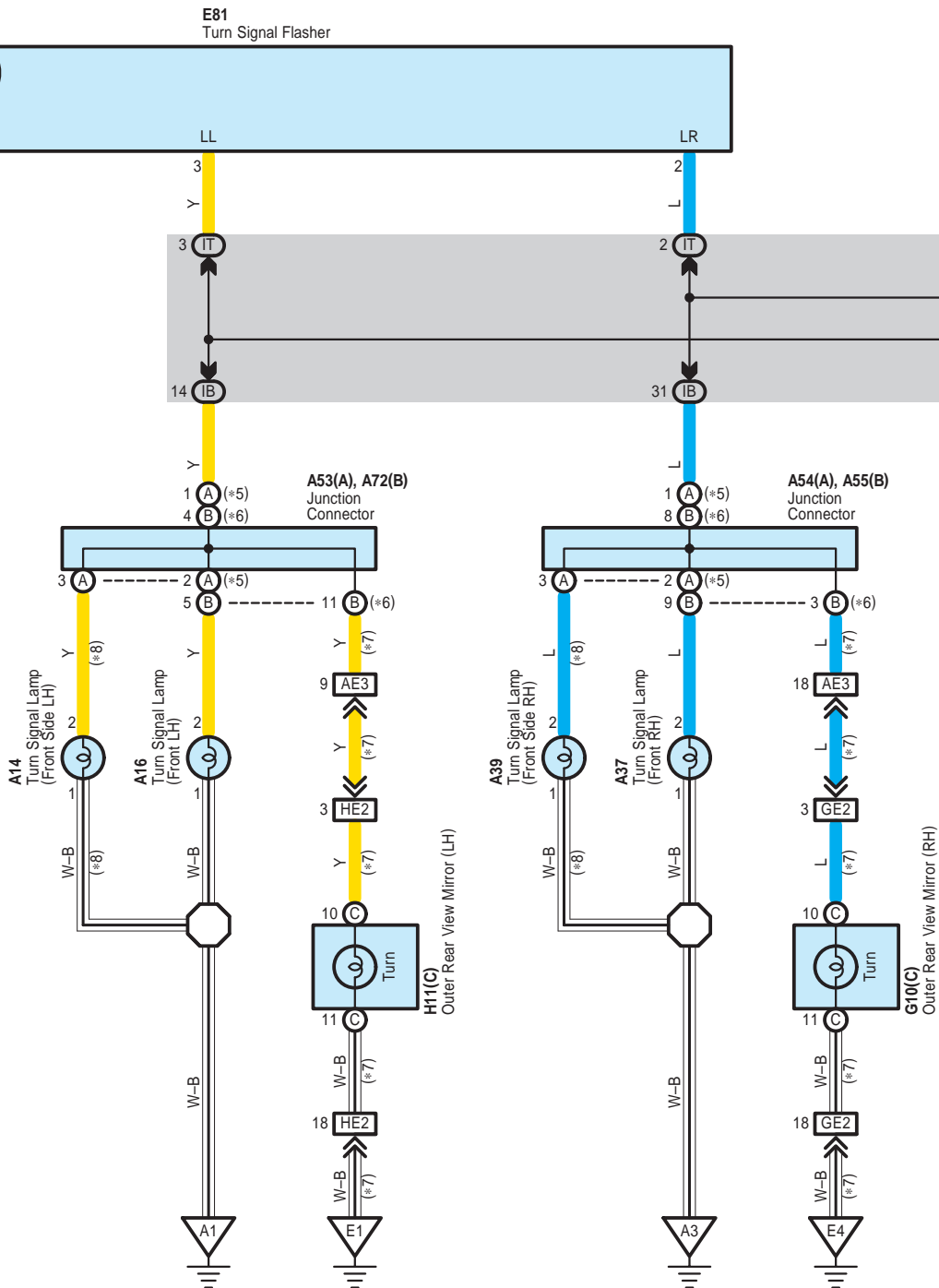

Turn Signal and Hazard Warning Light <RHD>

- * 3 : Australia
- * 4 : Except Australia
- * 5 : Before Aug. 2008 Production Except Europe, Before Dec. 2008 Production Europe
- * 6 : From Aug. 2008 Production Except Europe, From Dec. 2008 Production Europe

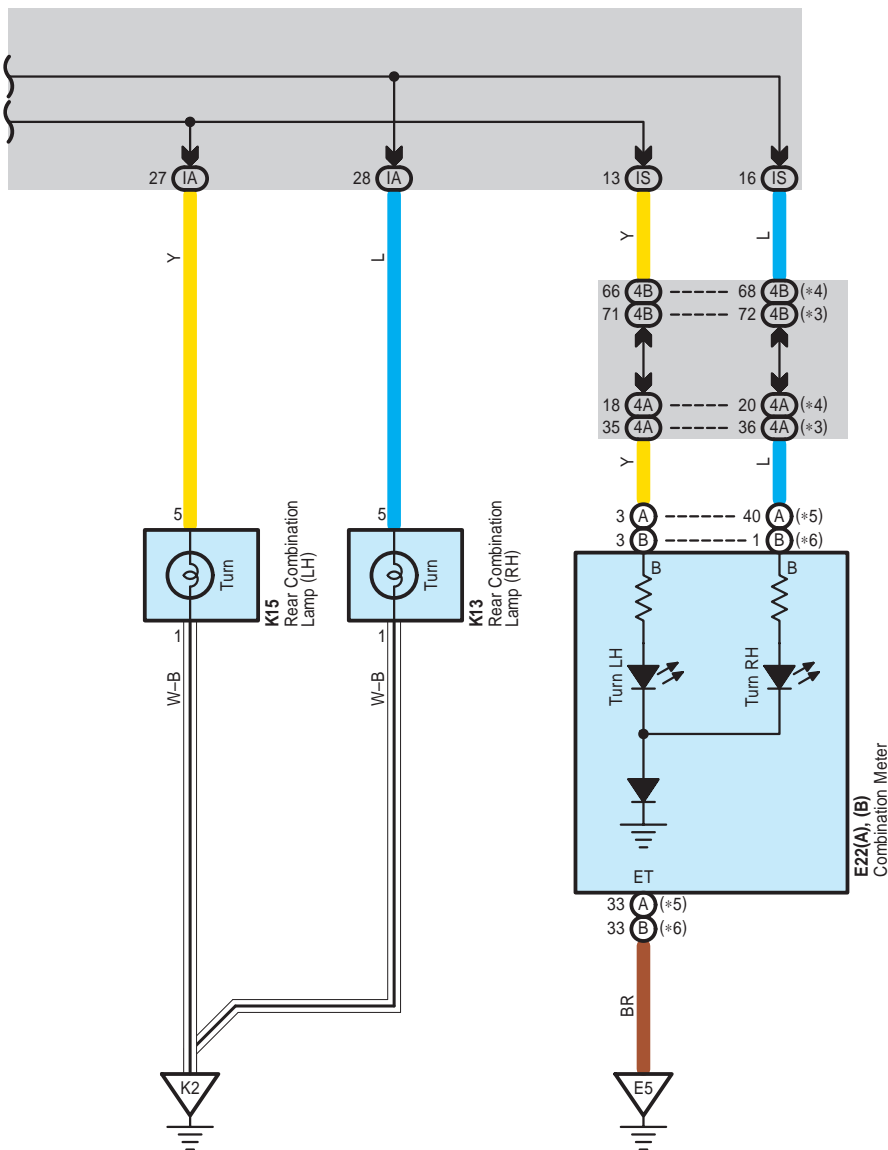

Turn Signal and Hazard Warning Light <RHD>

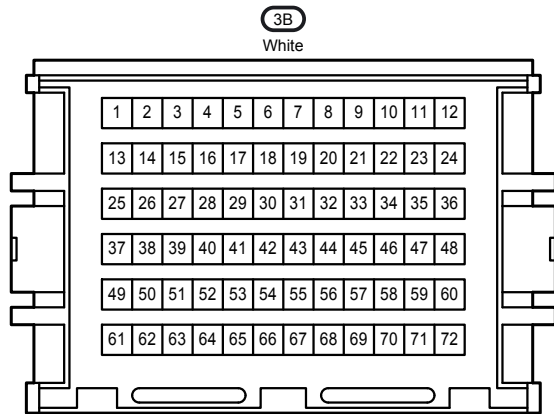
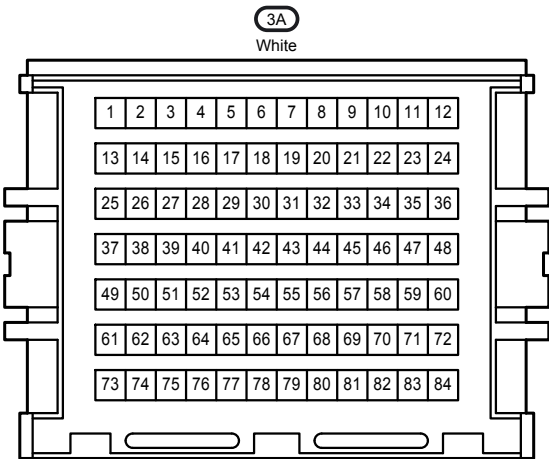
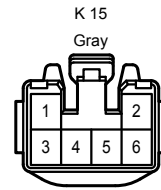
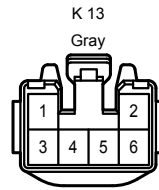
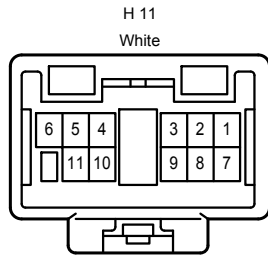
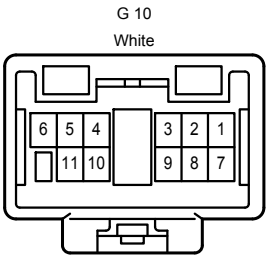
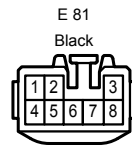
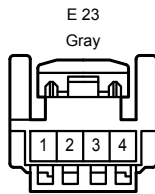
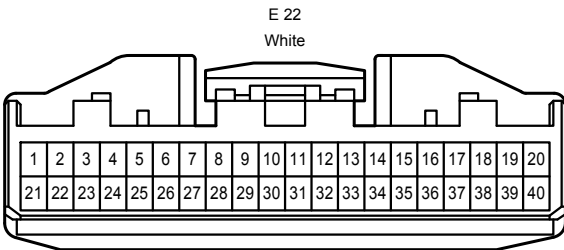
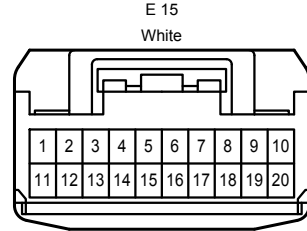
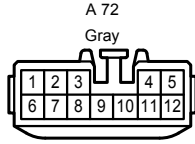
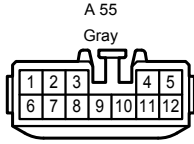
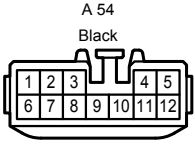
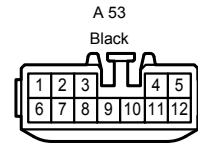
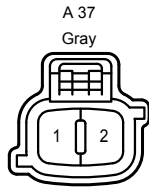
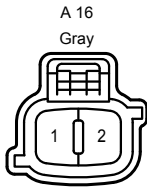
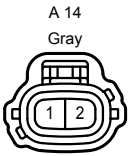

Turn Signal and Hazard Warning Light <RHD>

4A
White

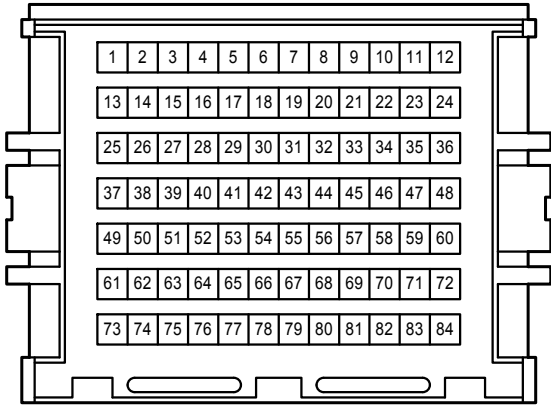

4B
White

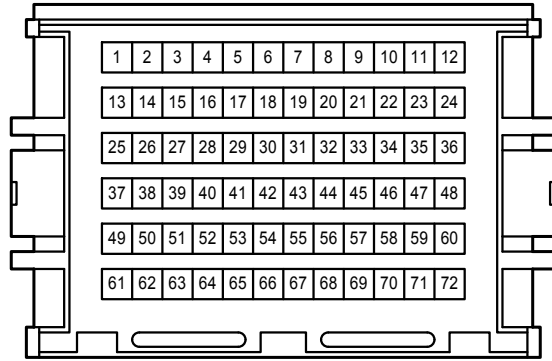

1A
White

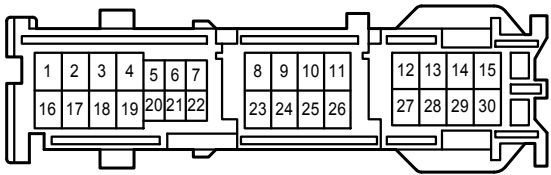

1B
White

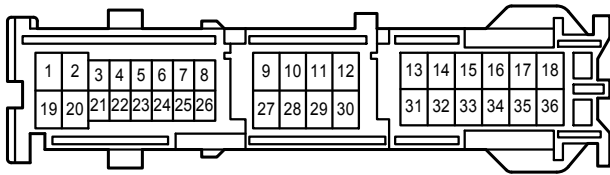

1E
White

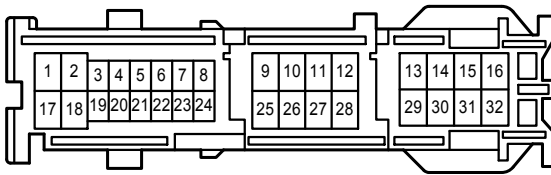

1M
White

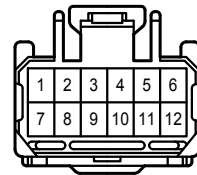

1S
White

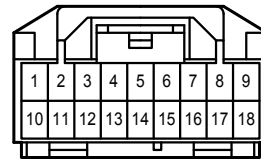

1T
White



AE3
Black

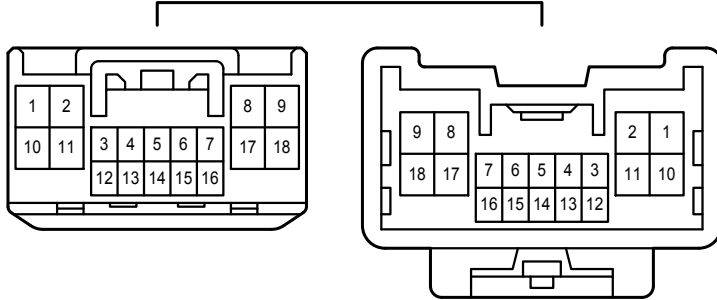

GE2
White

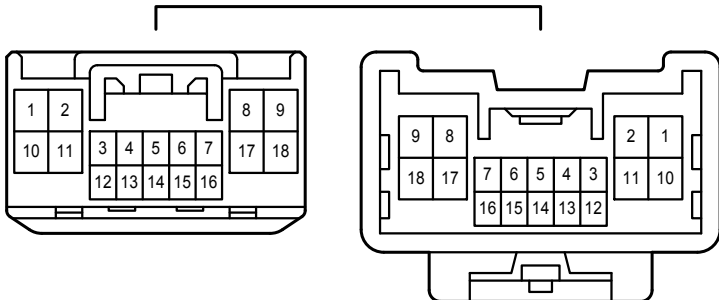

Turn Signal and Hazard Warning Light <RHD>

HE2
White

