

Wireless Door Lock Control <w/o Entry & Start System , LHD>

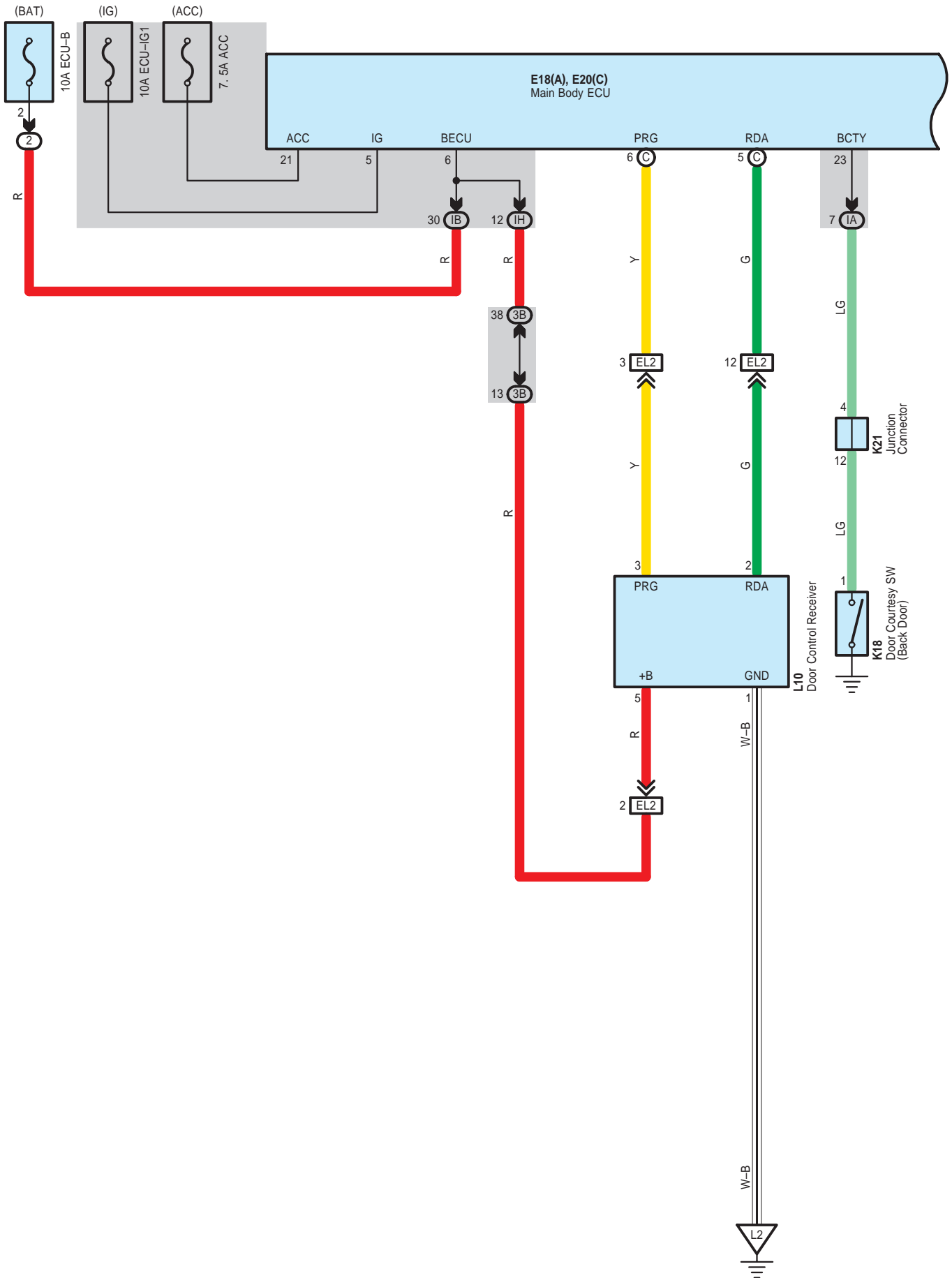

## Wireless Door Lock Control <w/o Entry & Start System , LHD>

- \* 3 : Before Aug. 2008 Production Except Europe, Before Dec. 2008 Production Europe
- \* 4 : From Aug. 2008 Production Except Europe, From Dec. 2008 Production Europe

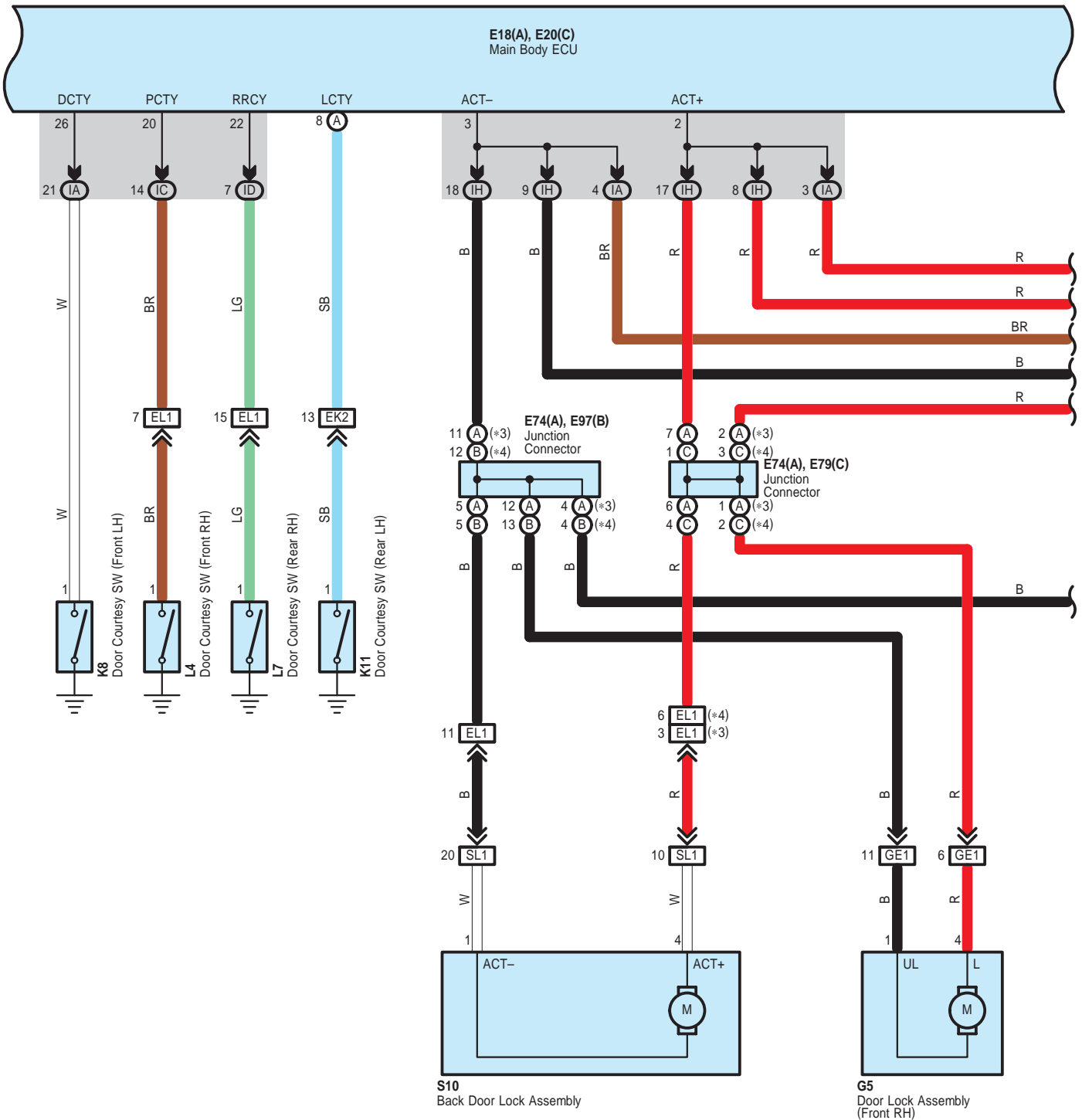

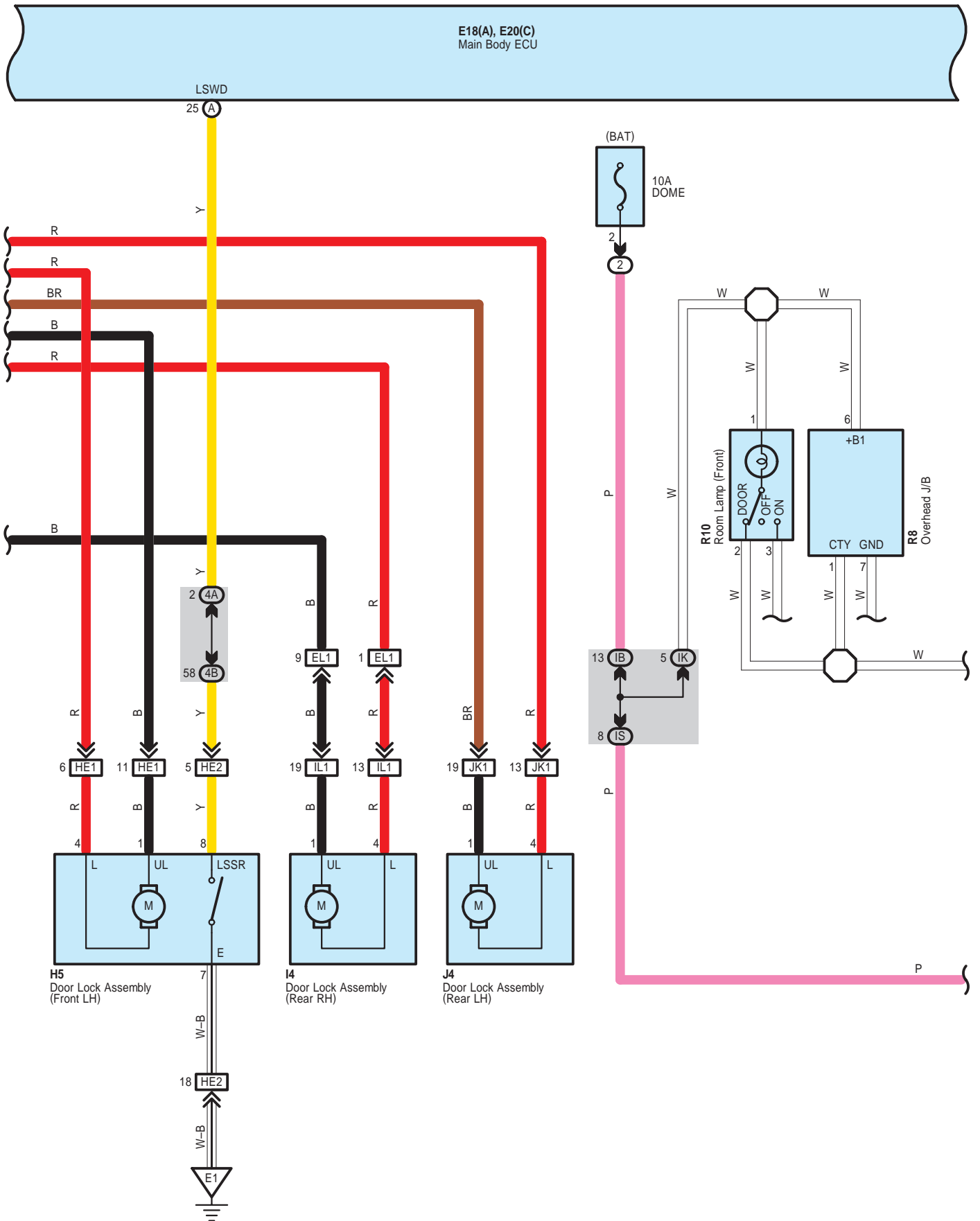

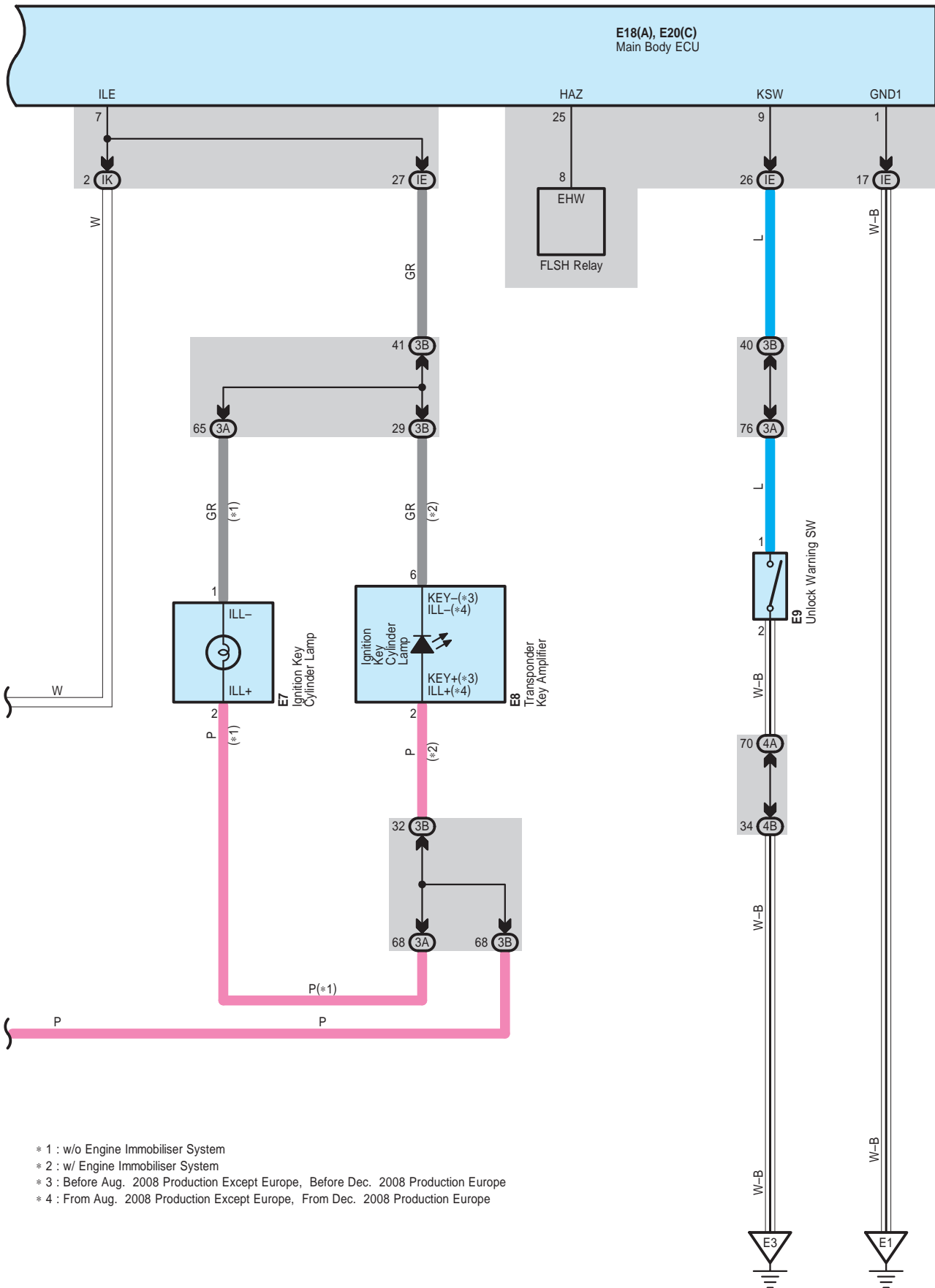

- \* 1 : w/o Engine Immobiliser System
- \* 2 : w/ Engine Immobiliser System
- \* 3 : Before Aug. 2008 Production Except Europe, Before Dec. 2008 Production Europe
- \* 4 : From Aug. 2008 Production Except Europe, From Dec. 2008 Production Europe

Wireless Door Lock Control <w/o Entry & Start System , LHD>

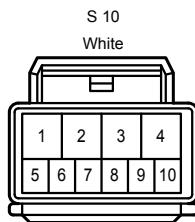
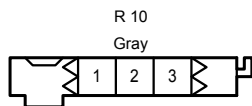
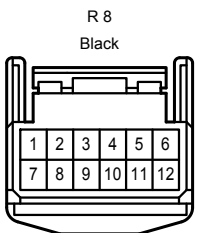
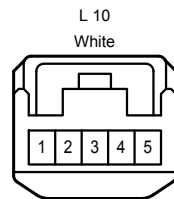
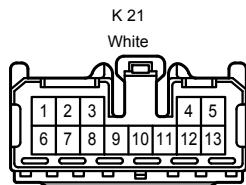
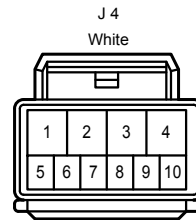
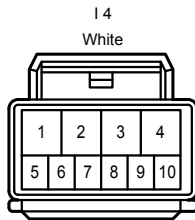
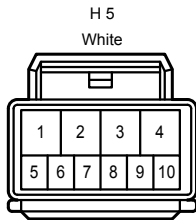
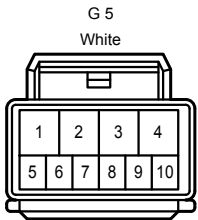
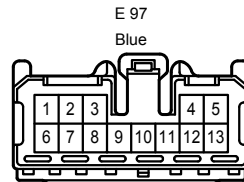
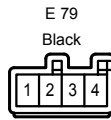
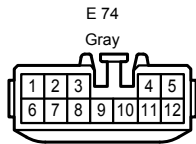
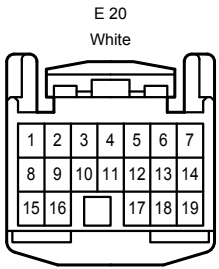
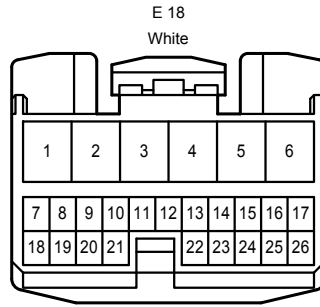
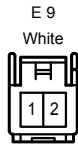
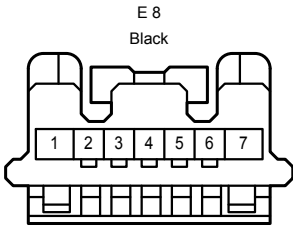
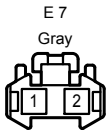

Wireless Door Lock Control <w/o Entry & Start System , LHD>

3A  
White

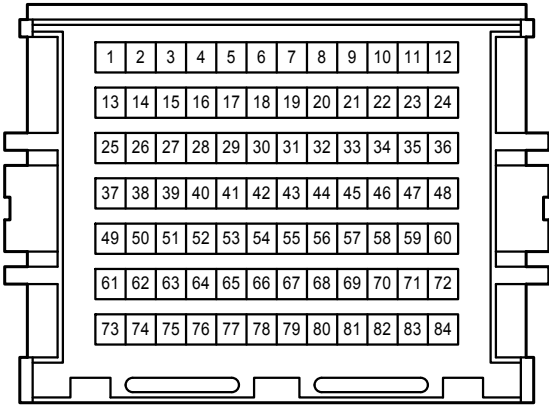

3B  
White

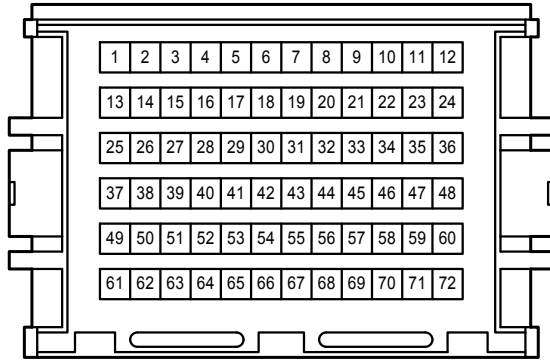

4A  
White

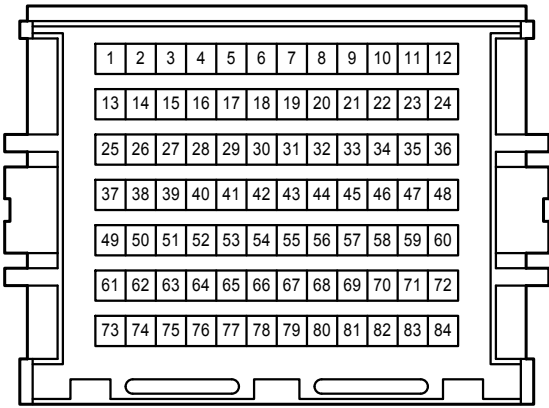

4B  
White

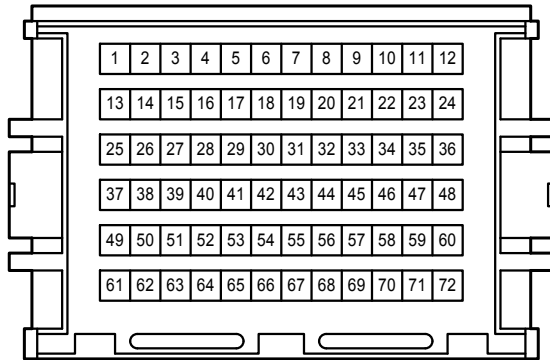

1A  
White

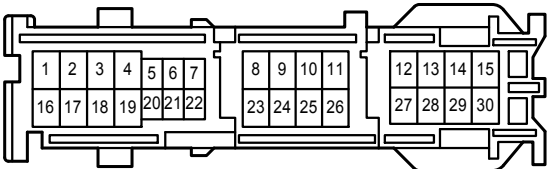

1B  
White

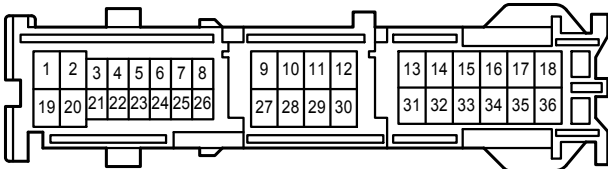

1C  
White

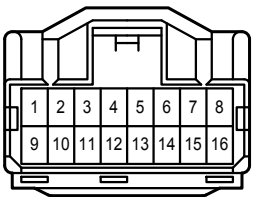

1D  
White

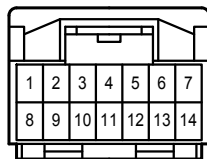

1E  
White

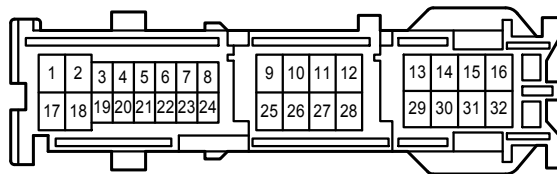

1H  
White

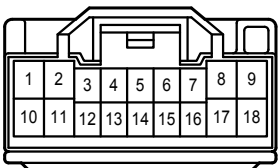

1K  
White



1S  
White

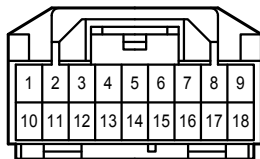

Wireless Door Lock Control <w/o Entry & Start System , LHD>

EK2  
White

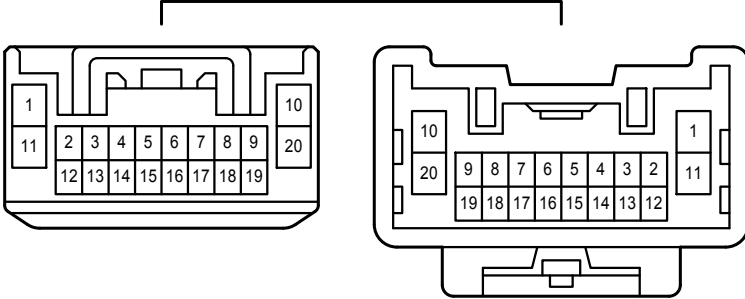

EL1  
White

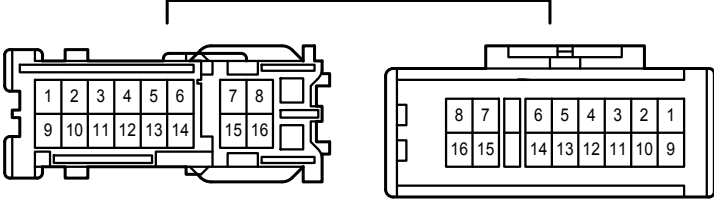

EL2  
White

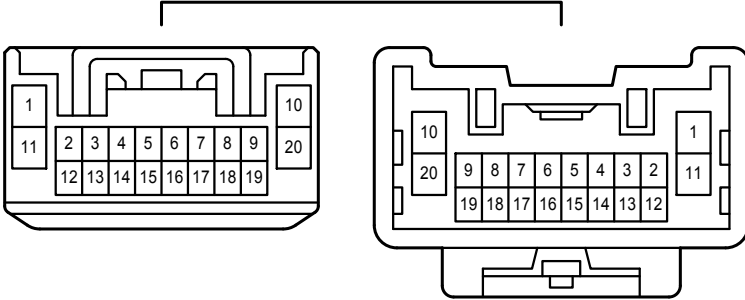

GE1  
White

HE1  
White

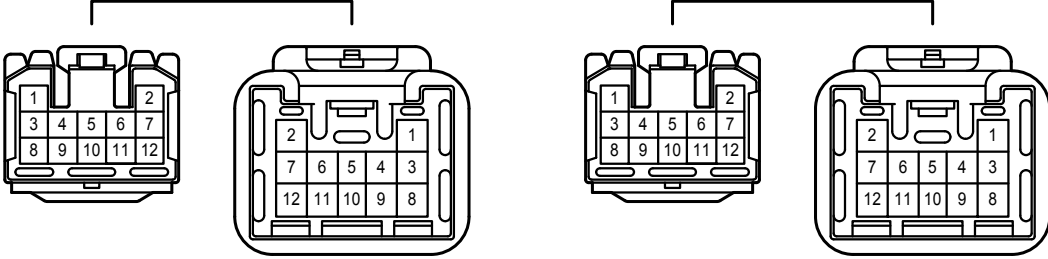

HE2  
White

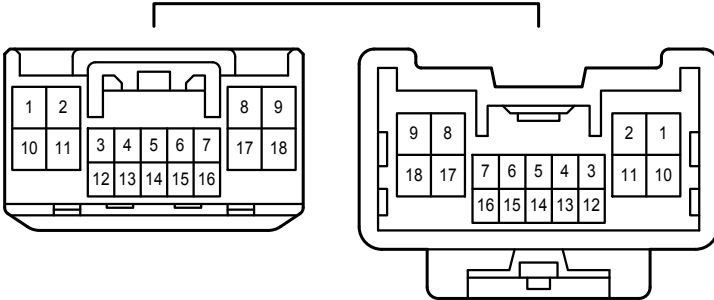

IL1  
White

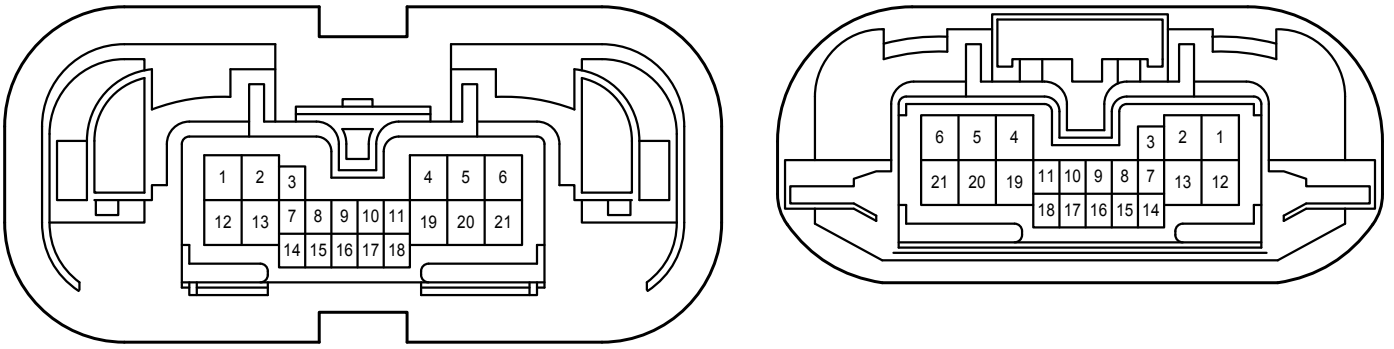

JK1  
White

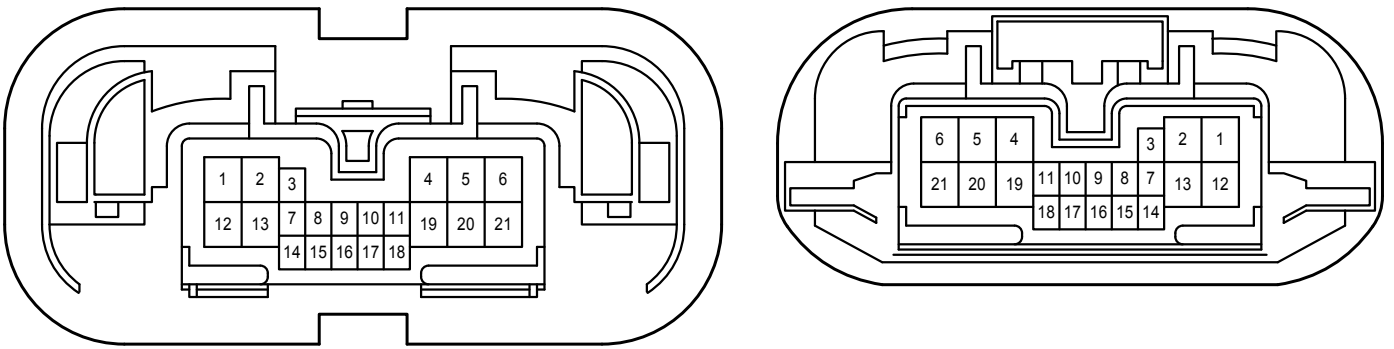

SL1  
White

