

USER MANUAL

VESTWOODS SK-8LNA-A HYBRID INVERTER/CHARGER 8000W 120/240 VAC

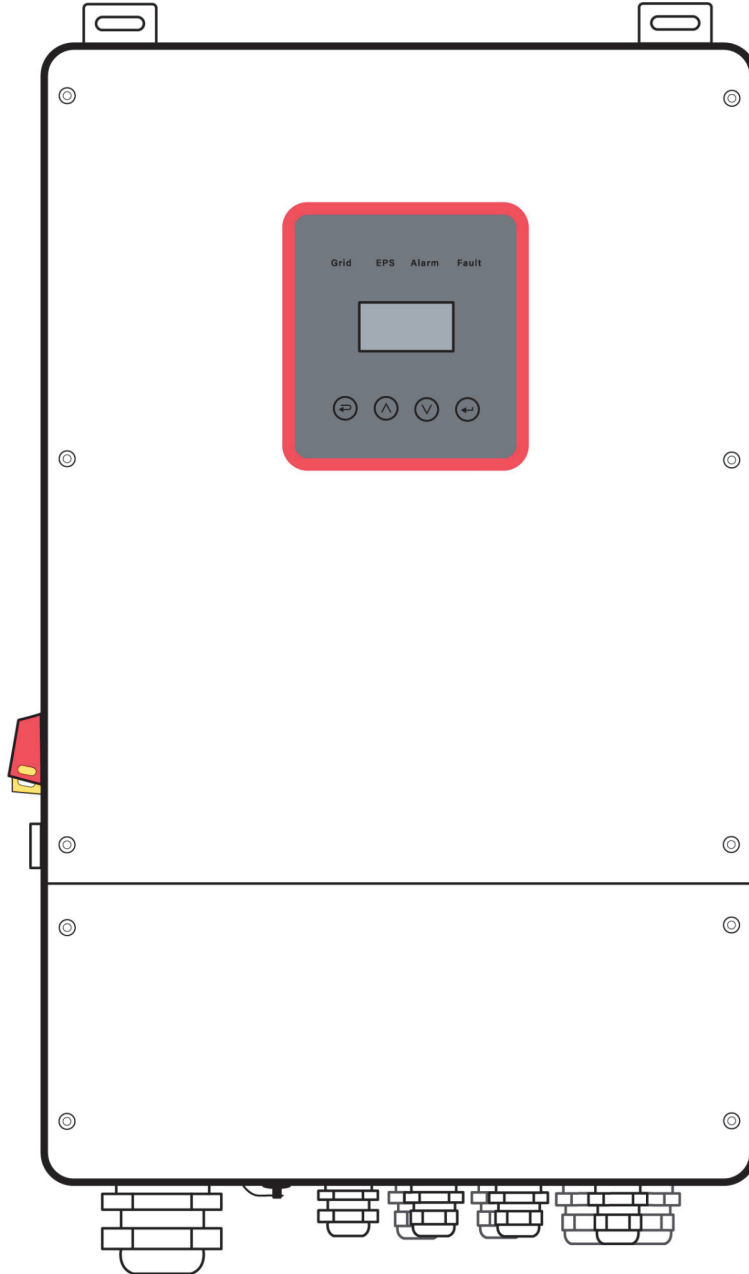

Table of Contents

1.	NOTES ON THIS MANUAL.....	3
1.1	SCOPE OF VALIDITY.....	3
1.2	TARGET GROUP.....	3
1.3	SYMBOLS USED.....	3
2.	SAFETY.....	4
2.1	IMPORTANT SAFETY INSTRUCTIONS.....	4
2.2	EXPLANATION OF SYMBOL.....	7
3.	INTRODUCTION.....	7
3.1	BASIC FEATURES.....	7
3.2	SYSTEM DIAGRAM.....	8
3.3	DIMENSION.....	9
3.4	TERMINALS OF PV INVERTER.....	9
4.	TECHNICAL PARAMETERS.....	10
4.1	INVERTER SPECIFICATION.....	10
5.	INSTALLATION.....	12
5.1	CHECK FOR PHYSICAL DAMAGE.....	12
5.2	PACKING LIST.....	12
5.3	MOUNTING.....	12
6.	ELECTRICAL CONNECTION.....	15
6.1	PV CONNECTION.....	15
6.2	GRID CONNECTION (GEN CONNECTION).....	16
6.3	LOAD1 AND LOAD2 CONNECTION.....	17
6.4	BATTERY CONNECTION.....	19
6.5	WIFI CONNECTION (OPTIONAL).....	21
6.6	CT INSTALLATION INSTRUCTIONS.....	21
7.	LCD OPERATION.....	22
7.1	CONTROL PANEL.....	22
7.2	INSTRUCTIONS FOR LED INDICATOR.....	22
7.3	WORK MODES.....	23
7.4	OUTLINE FOR SETTINGS MENU.....	24
8.	LCD OPERATION.....	26
8.1	LCD INTERFACE.....	26
8.2	SETTING.....	30
9.	FAULT DIAGNOSIS AND SOLUTIONS.....	43
10.	INVERTER PARALLEL GUIDE.....	46
10.1	PARALLEL SYSTEM DIAGRAM.....	46
10.2	PARALLEL COMMUNICATION CABLE CONNECTION.....	47
10.3	PARALLEL OPERATION NOTES.....	47
10.4	PARALLEL SYSTEM SETTINGS.....	48
	STICK LOGGER GUIDE.....	49
11.	GENERATOR USE OPERATION GUIDE.....	51
12.	Advanced Mode Operation Guide.....	54

1 Notes on this Manual

1.1 Scope of Validity

This manual describes installation, commissioning, operation, and troubleshooting. Please read the manual fully and carefully before installing and operating. This manual provides basic safety and installation guidelines as well as information on tools and wiring. Keep this manual for future use.

1.2 Target Group

This manual is for qualified electricians and owner/builders with qualified electrician oversight.

1.3 Symbols Used

The following types of safety instructions and general information appear in this document as described below:

	Danger! "Danger" indicates a hazardous situation which, if not avoided, will result in death or serious injury.
---	---

	Warning! "Warning" indicates a hazardous situation which, if not avoided, could result in death or serious injury.
---	--

	Caution! "Caution" indicates a hazardous situation which, if not avoided, could result in minor or moderate injury.
---	---

	Note! "Note" provides tips that are valuable for optimal operation.
---	---

2 Safety

2.1 Important Safety Instructions



- Danger!**
- Danger to life due to high voltages in the inverter!
 - All work must be carried out by qualified electrician.
 - The appliance is not to be used by children or persons with reduced physical sensory or mental capabilities, or lack of experience and knowledge, unless they have been given supervision or instruction.
 - Children should be supervised to ensure that they do not play with the appliance.



- Caution!**
- Danger of burn injuries due to hot enclosure parts!
 - During operation, the upper lid of the enclosure and the enclosure body may become hot.
 - Only touch the lower enclosure lid during operation



- Caution!**
- Possible damage to health as a result of the effects of radiation!
 - Do not stay closer than 20 cm to inverter for any length of time.



- Note!**
- Comply with the local requirements for grounding the PV modules and the PV generator. It is recommended connecting the generator frame and other electrically conductive surfaces in a manner which ensures continuous conduction and ground these in order to have optimal protection of system and persons.



- Warning!**
- Ensure input DC voltage \leq Max. DC voltage. Over voltage may cause
 - Permanent damage to inverter or other losses, which will not be included in warranty!

**Warning!**

- Authorized service personnel must disconnect both AC and DC power from inverter before attempting any maintenance or cleaning or working on any circuits connected to inverter.

**Warning!**

- Do not add/remove live wires.

**Warning!**

- Risk of electric shock!

- Please keep this user manual for future use. Always follow the precautions, and safety instructions in this document. The distributor will not be liable for any consequence caused by the violation of the safety regulations, design, production, and usage standards.
- Only accessories included with the inverter shipment are recommended for use with the inverter. Modification or unapproved components may result in a risk of fire, electric shock, or injury to person.
- Make sure that existing wiring is in good condition and that wire is not undersized. Do not disassemble any parts of the inverter which are not mentioned in the installation guide. It contains no user-serviceable parts. See Warranty for instructions on obtaining service. Attempting to service the inverter yourself may result in a risk of electric shock or fire and will void your warranty.
- Keep away from flammable, explosive materials to avoid possible fires.
- The installation place should be away from humid or corrosive substances.
- Authorized service personnel must use insulated tools when installing or working with this equipment.
- Never touch either the positive or negative pole of a PV connecting device. Never touch both of them at the same time.
- The unit contains capacitors that remain charged to a potentially lethal voltage after the utility, battery and PV supply has been disconnected.
- Hazardous voltage will present for up to 5 minutes after disconnection from the power supply.
- CAUTION-RISK of electric shock from energy stored in capacitor, never perform maintenance on the inverter couplers, utility cables, battery cables, or PV cables while power is applied. After switching off the PV, battery and utility; wait for 5 minutes to let the intermediate circuit capacitors discharge before unplugging PV, battery, and utility couplers.
- When accessing the internal circuit of the inverter, it is very important to wait 5 minutes before operating the power circuit or demounting the electrolyte capacitors inside the device. Do not open the device beforehand since the capacitors require time sufficiently discharge!
- Please use surge protection devices (SPDs) for PV installation.



WARNING!

Over-voltage protection with surge arresters should be provided when the PV power system is installed.

- Lightning will cause damage either from a direct strike or from surges due to a nearby strike.
- Induced surges are the most likely cause of lightning damage in majority or installations, especially in rural areas where electricity is usually provided by long overhead lines. Surge may be included on both the PV array conduction and the AC cables leading to the building.
- Specialists in lightning protection should be consulted during the end use application. Using appropriate external lightning protection, the effect of a direct lightning strike into a building can be mitigated in a controlled way.
- Installation of SPDs to protect the inverter against mechanical damage and excessive stress include a surge arrester in case of a building with external lightning protection system (LPS) when separation distance is kept.
- To protect the DC system, a surge suppression device (SPD type2) should be fitted at the inverter end of the DC cabling and at the array located between the inverter and the PV generator. If the voltage protection level (VP) of the surge arresters is greater than 1100V, an additional SPD type 3 is required for surge protection for electrical devices.
- To protect the AC system, surge suppression devices (SPD type2) should be fitted at the main incoming point of AC supply (at the consumers cutout), located between the inverter and the meter/distribution system.
- All DC cables should be installed to provide as short a run as possible, and positive and negative cables of the string or main DC supply should be bundled together. This avoids the creation of loops in the system.
- Spark gap devices are not suitable to be used in DC circuits once conducting, they won't stop conducting until the voltage across their terminals is typically more than 30 volts.

➤ **Anti-Islanding Effect**

Islanding effect is a special phenomenon that grid-connected PV system still supply power to the nearby grid when the voltage loss is happened in the power system. It is dangerous for maintenance personnel and the public. This inverter provides Active Frequency Drift(AFD) to prevent islanding effect.

➤ **PE Connection and Leakage Current**

The end-use application shall monitor the protective conductor by residual current operated protective device (RCD) with rated fault current $I_{fn} \leq 240\text{mA}$. This automatically disconnects the device in case of a fault. The device is intended to connect to a PV generator with a capacitance limit of approximately 700nf.



WARNING!

High leakage current!
Earth connection essential before connecting supply.

Incorrect grounding can cause physical injury, death or equipment malfunction.











➤ Battery Safety Instructions

This inverter must use low voltage batteries. For the specific parameters such as battery type, nominal voltage and nominal capacity etc., please refer to section 4.3.

Connecting batteries in parallel contains risk of potential electric shock and short-circuit current danger. To avoid accidents, the following warnings should be observed during battery replacement:

- 1: Do not wear watches, rings or similar metallic items.
- 2: Use insulated tools.
- 3: Put on rubber shoes and gloves.
- 4: Do not place metallic tools and similar metallic parts on the batteries.
- 5: Switch offload connected to the batteries before dismantling battery connection terminals.
- 6: Only personnel with proper expertise can carry out the maintenance of batteries.

2.2 Explanation of Symbols

	CSA certified
	This symbol indicates that you should wait at least 5mins after disconnecting the inverter from the utility grid and from the PV panel before touching any inner live parts.
	keep dry! The package/product must be protected from excessive humidity and must be stored under cover.
	Refer to the operating instructions.
	fragile - The package/product should be handled carefully and never be tipped over or slung.
	Products should not be disposed as household waste.
	No more than <u>six(6)</u> identical packages being stacked on each other
	Components of the product can be recycled.
	Danger of hot surface!
	Danger of high voltage and electric shock!
	Caution! Failure to observe a warning indicated in this manual may result in injury

3. Introduction

3.1 Basic features

The Vestwoods 12KEXP-240 is a high-quality hybrid inverter which can convert solar energy to AC energy and store the energy in batteries. This inverter can be used to optimize self-consumption, store in the battery for future use or feed into the public grid. Work mode depends on PV energy and the user's preference. It can provide power for emergency use during grid loss by using the energy from the battery and inverter (generated from PV).

3.2 System Diagram

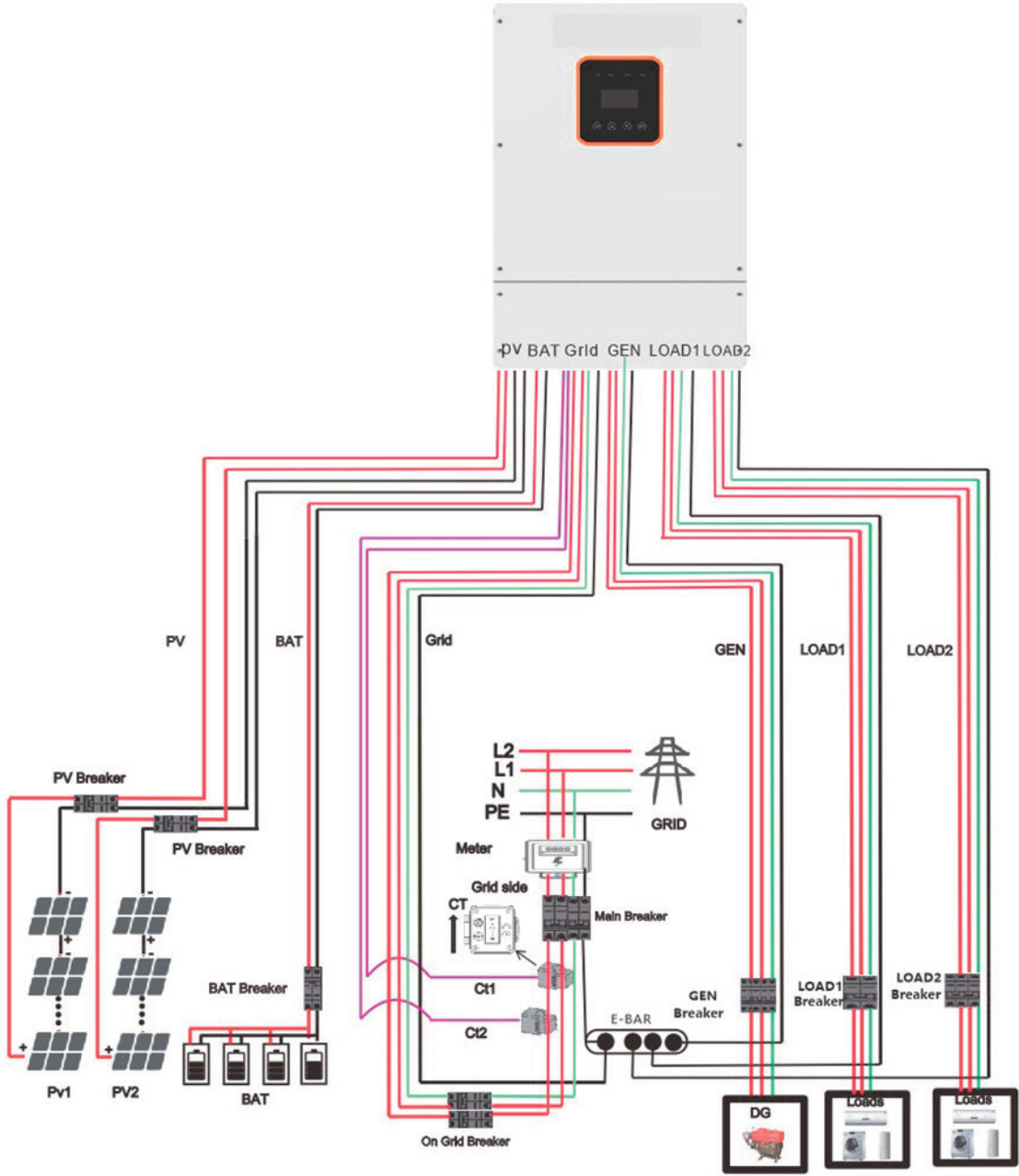

3.3 Dimension

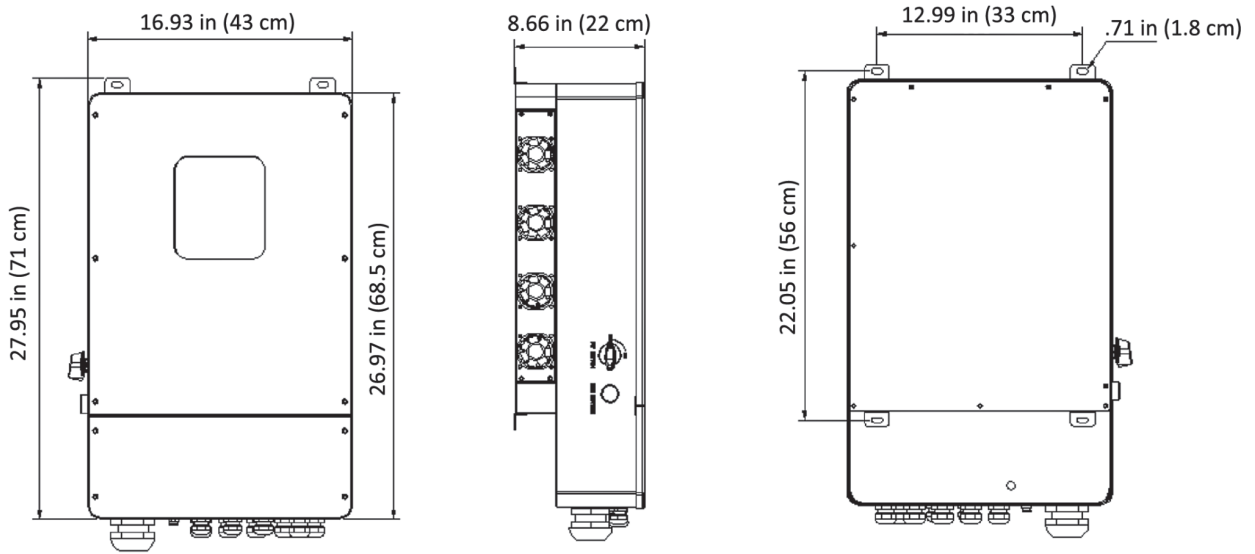

3.4 Terminals of PV inverter

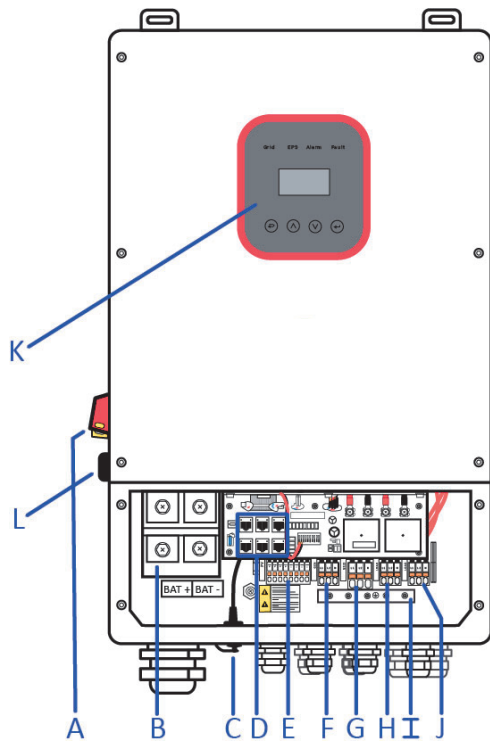

Object	Description
A	DC switch
B	BAT input
C	WIFI
D	DRM/BMS/CT/DRY IO/CAN/USB upgrading
E	PV1 ~PV4 input
F	Generator
G	Grid
H	Load 1 output
I	PE (Ground)
J	Load 2 output
K	LCD
L	Power enabled button

WARNING!
 Qualified electrician will be required for the installation.

4. Technical Parameters

4.1 Inverter specification

Technical Data	8KEXP-240
PV Input Data	
MAX.DC Input Power	12KW (3KW per MPPT)
NO. MPPT Tracker	4
MPPT Range	120 - 500V
MAX.DC Input Voltage	500V
MAX.Input Current/Short Circuit Input	12A/15A (per MPPT)
Battery Input Data	
Nominal voltage (Vdc)	48V
MAX. Charging/Discharging Current	190A/190A
Battery Voltage Range	40-60V
Battery Type	Lithium and Lead Acid Battery
Charging Strategy for Li-Ion Battery	Self-adaption to BMS
AC Output Data (On-Grid)	
Nominal output power Output to Grid	8kw
MAX. Apparent Power Output to Grid	8.8kw
Output Voltage Range	110-120/220-240V split phase
Output Frequency	50/60Hz (45 to 54.9Hz / 55 to 65Hz)
Nominal AC Current Output to Grid	33.3A
Max.AC Current Output to Grid	36.7A
Output Power Factor	0.8leading...0.8lagging
Output THDI	< 2%
AC Output Data	
Nominal. Apparent Power Output	8kw
MAX. Apparent Power Output	8.8kw
Nominal Output Voltage L-N/L1-L2	120/240V
Nominal Output Frequency	60Hz
Output THDU	< 2%
Efficiency	
Europe Efficiency	> =97.8%
MAX. Battery to Load Efficiency	> =97.2%
Protection	
Grounding detection	YES
Arc Fault Protection	YES
Island Protection	YES

Battery reverse Polarity	YES
Insulation Resistor Detection	YES
Residual Current Monitoring Unit	YES
Output Over Current Protection	YES
Back-up Output Short Protection	YES
Terminal temperature detection	YES
Output Over Voltage Protection	YES
Output Under Voltage Protection	YES
General Data	
Output Conduit	25.4mm
PV Input Conduit	25.4mm
BAT Input Conduit	34.5mm
Operating Temperature Range	-25 ~ +60°C
Relative Humidity	0-95%
Operating Altitude	0~3000m
Ingress Protection	IP65/NEMA 3R
Weight	32kg
Size (Width*Height*Depth)	16.93 in. x 27.95 in. x 8.66 in.
Cooling	Natural Convection
Noise emission	<38dB
Display	LCD
Communication With BMS/Meter/EMS	CAN
Supported communication interface	WLAN, 4G (optional)
Self-consumption at night	< 2.5 W (with battery enabling < 5 W)
Safety	UL1741SA all options, UL1699B, CSA 22.2
EMC	FCC Part 15 Class
Grid connection standards	IEEE 1547, IEEE 2030.5, Hawaii Rule 14H, Rule 21 Phase I, II, III

5. Installation

5.1 Check for Physical Damage

Make sure the inverter is intact after transportation. If there is any visible damage, please contact your distributor immediately.

5.2 Packing List

Open the package and take out the product, please check the accessories first. The packing list is shown below.

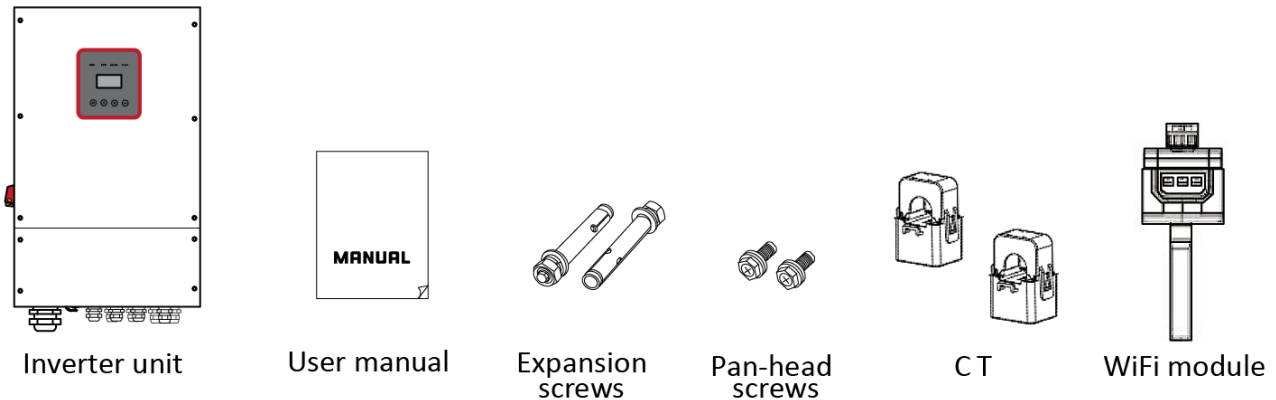

5.3 Mounting

➤ Installation Precaution

Inverter is designed for outdoor installation (IP 65). Make sure the installation site meets the following conditions:

- Not in direct sunlight.
- Not in areas where highly Flammable materials are stored.
- Not in potential explosive areas.
- Not exposed to direct cold winds.
- Not near the television antennas or antenna cables.
- Not higher than the altitude of about 3000m above sea level.
- Not in environment of precipitation or humidity (>95%).
- Use in a well ventilated area.
- The ambient temperature is in the range of -20°C to +60°C.
- The slope of the wall should be within $\pm 5^\circ$.
- When mounting the inverter, the wall must meet the conditions below:
 1. solid brick/concrete, or strength equivalent mounting surface.
 2. Inverter mount must be supplementally supported if the mounting surface strength isn't strong enough.

Please AVOID direct sunlight, rain exposure, snow laying up during installation and operation.



➤ Space Requirement

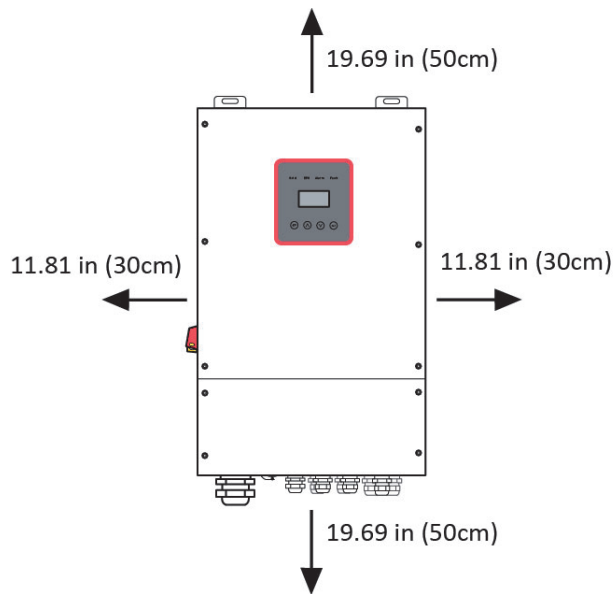

➤ Mounting

Tools required for installation.

Installation tools: drill, crimping pliers, screwdriver, adjustable wrench, etc.



Step 1: Drill 4 holes in the wall according to the following dimensions, 2-2.4 inch depth. Then use a proper hammer to fit the expansion bolt into the holes.

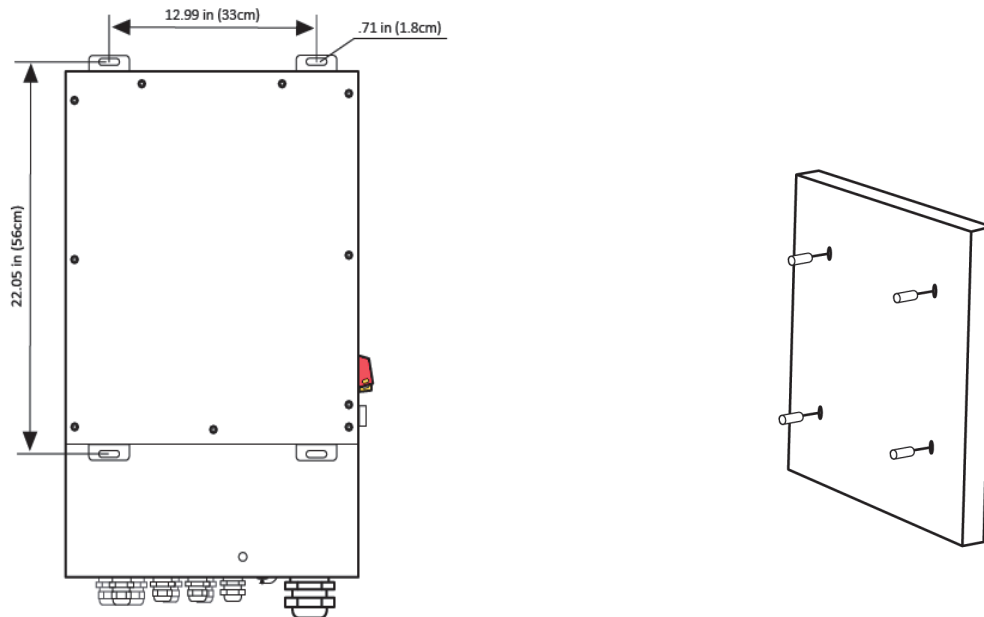

Step 2: Lift up the inverter and align the holes of the inverter with the expansion bolt, mount the inverter on the wall.

Step 3: Tighten the nut of the expansion bolt and install a tamper proofing lock on the DC switch of the inverter.

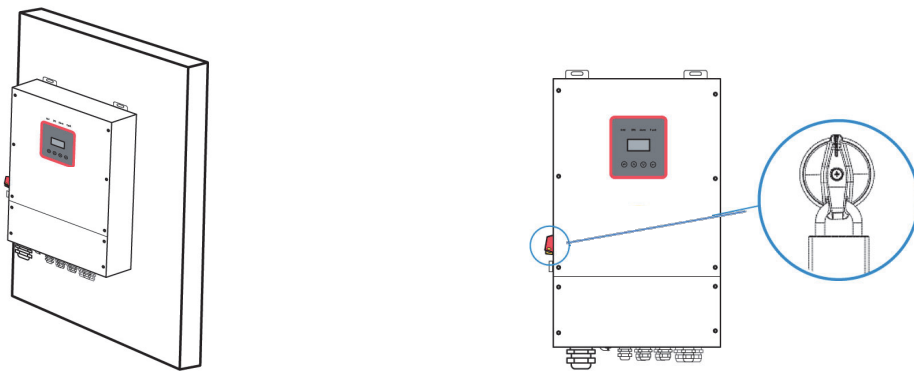

Step 4: Use an allen wrench to remove the cover screws, and remove the cover. Remove the waterproof cover with a flat-head screwdriver. Wiring box conduit plugs are provided for 1 inch conduit fittings. If conduit being used is not 1 inch, an appropriate conduit adapter should be used.

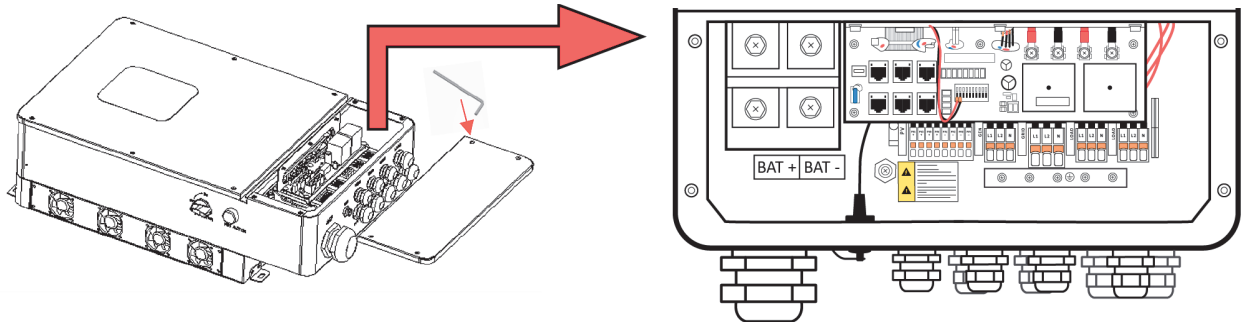

Step 5: Insert the conduit and fasten the joint.

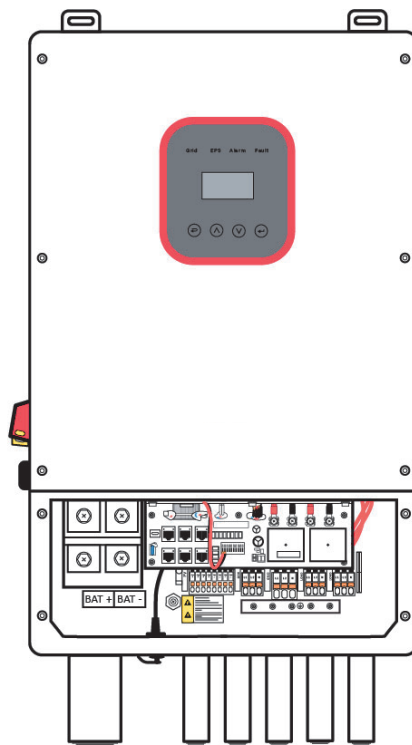

6. Electrical Connection

6.1 PV connection

This inverter can be connected with 4-strings of PV modules for 12kW (3kW per MPPT). Select PV modules within specs and reliable quality. Open-circuit voltage of module arrays connected in series should be less than max, temperature adjusted DC input voltage in accordance with NEC compliance. Operating voltage should be conformed to MPPT voltage range along with appropriate sized breakers.

Step1. Wiring.

- 1.1 Use 10 AWG wire to connect with ferrules.
- 1.2 Remove 18mm of insulation from the end of the wire.

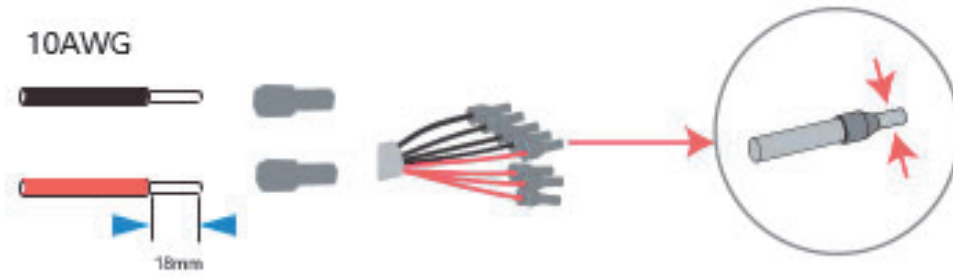

Step2. Feed the PV cables through the PV port, and connect the PV cables to the PV terminals.

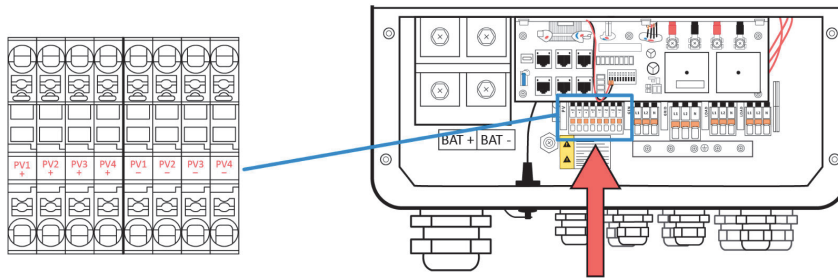

6.2 Grid Connection

Step1. Check the grid voltage.

- 1.1 Check the grid voltage and compare to acceptable voltage ranges (Please refer to technical data).
- 1.2 Disconnect the circuit board, and secure against re-connection.

Step2. Grid cables

Model	8KEXP-240
Cable	8AWG

Step3. Connect the 8 AWG wire to ferrules. (Remove 18mm of insulation from the end of the wire.)

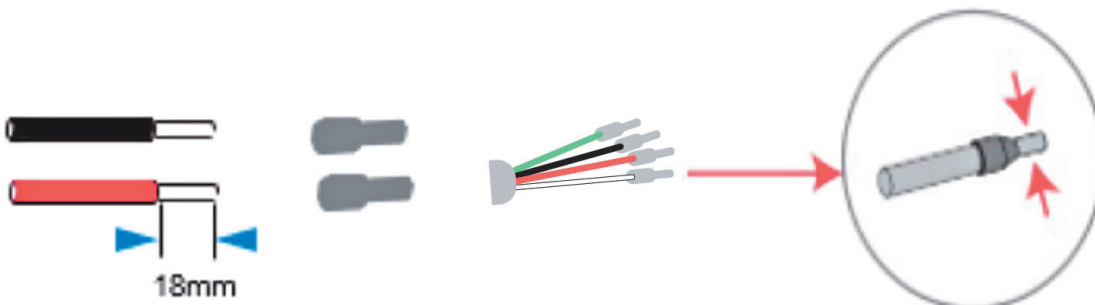

Step4. Feed the grid cables through the grid port and connect grid cables to grid terminals.

Model	8KEXP-240
Breaker	40A

6.3 Load1 and Load2 Connection

This inverter has On and Off grid function. The inverter will deliver power through AC output ports when the grid is on and it will deliver output power through Load 1 port when the grid is off.

- Load1 port: Critical loads.
 - Load2 port: When the grid is not present, the load on this interface will power down.
- 1). For inverters, the standard PV installation typically consists of the connection of the inverter with both panels and batteries. In case of systems not connected to batteries, it is strongly advised not to use the Critical Loads function. The warranty will not cover damages caused by not following this advice.
 - 2) This inverter has self-protection derating at high ambient temperature.
 - 3) For complicated applications, or special loads, please contact your distributor.

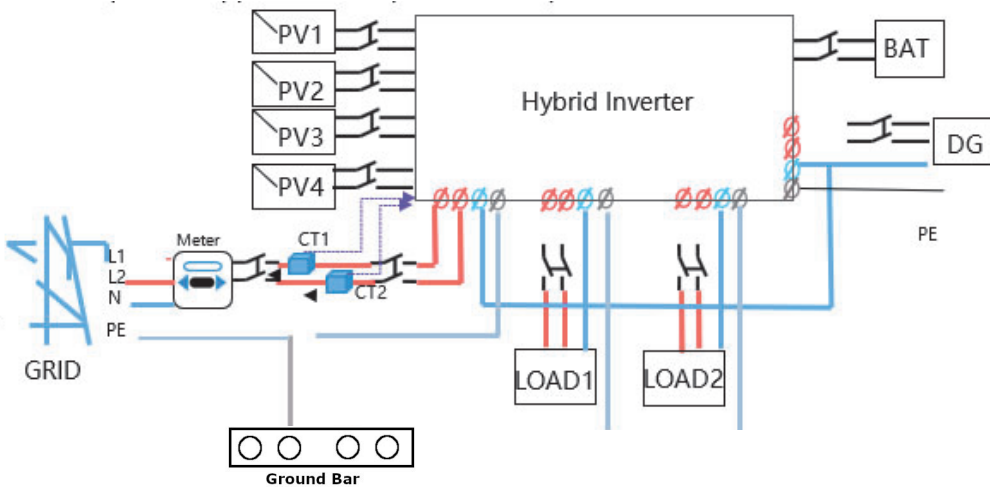

Load1 and Load2 Connection:

When using the off-grid function, please add an off grid AC breaker in off grid output cable to ensure safety.

Model	8KEXP-240
Breaker	40A

Note: When using the off-grid function, the absence of an AC breaker on the AC output side will lead to inverter damage if an electrical short circuit happens on the AC output side.

Step1. Make AC output wires.

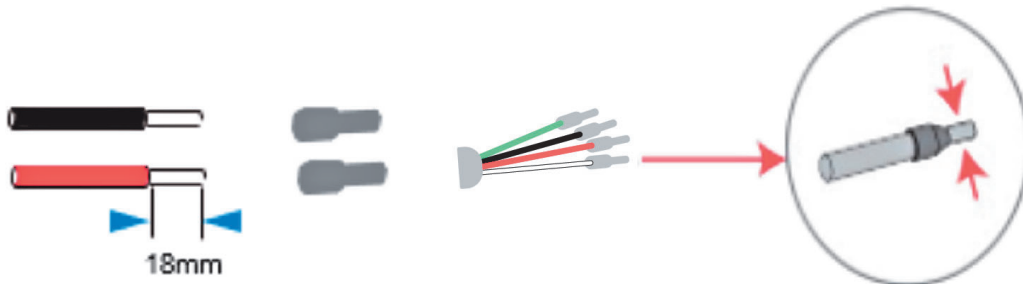

Model	8KEXP-240
Cable	8AWG

Step2. Feed the Load1 and Load2 cables through the ports of the inverter and connect to Load 1 and Load 2 terminals.

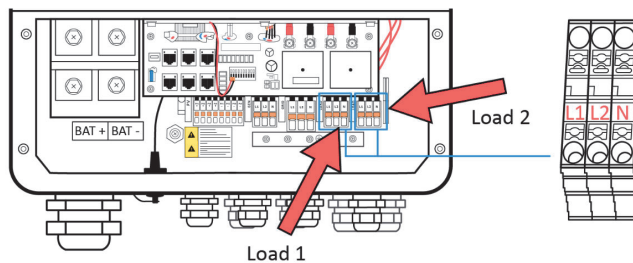

Warning!
 Make sure the load power rating is within the output rating, otherwise the inverter will shut down with an "overload" warning.

 When an "overload" has appeared, adjust the load power to make sure it is within the output power range, then turn the inverter back on.

For the nonlinear load, please make sure the inrush power is within the output power range.

6.4 Battery Connection

The charging & discharging system of this inverter is designed for a 48V lithium battery. Before choosing a battery, please note the maximum voltage of the battery can't exceed 60V and the battery communication should be compatible with this inverter.

➤ Battery breaker

Before connecting to the battery, please install a non-polarized DC breaker to make sure the inverter can be securely disconnected during maintenance.

Model	8KEXP-240
Current[A]	200A

➤ Battery connection diagram

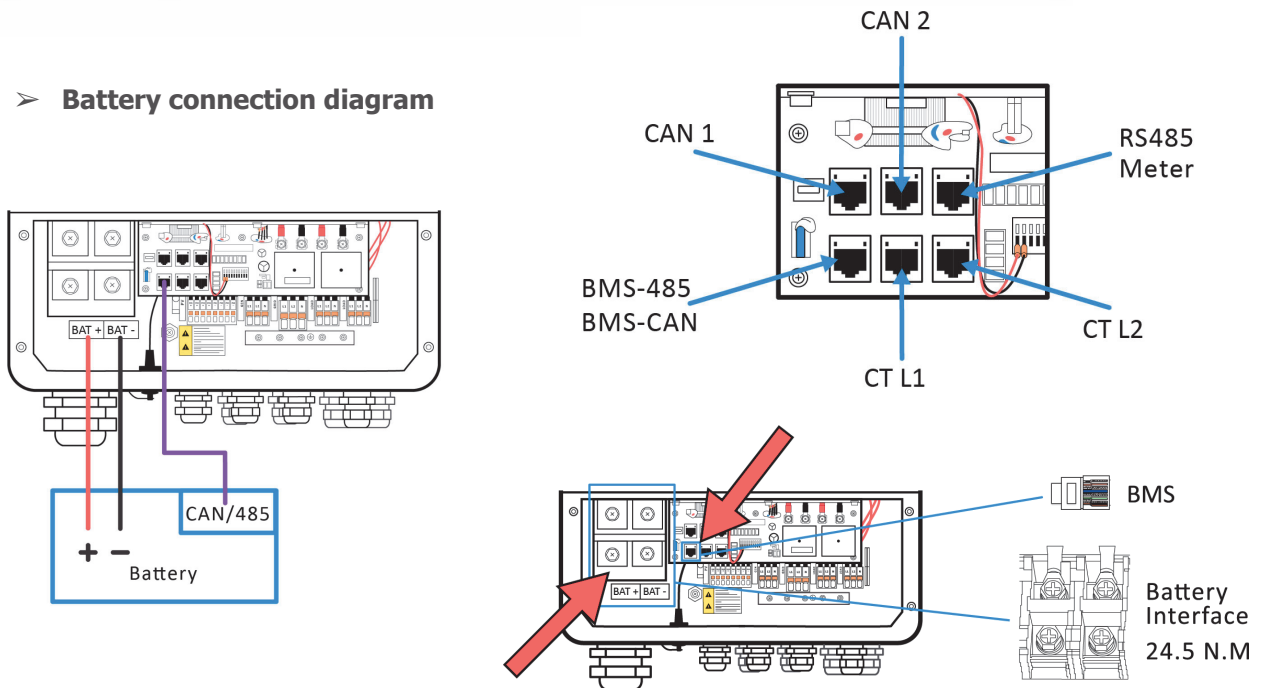

➤ BMS PIN Definition

Communication interface between inverter and battery is RS485 or CAN with an RJ45

	PIN	1	2	3	4	5	6	7	8
CAN	Definition	X	X	X	BMS_CANH	BMS_CANL	X	X	X
RS485	Definition	X	X	X	X	X	GND	BMS_485B	BMS_485A

Model	8KEXP-240
Cable	2/0 AWG

➤ Connecting Battery Power To Inverter:

Step 1. Use the 2/0 AWG wire and strip the cable to 15mm. Select two O-terminals with an aperture of M8. Insert the stripped line into the O-terminal and clamp it with a crimping clamp.

Step 2. Insert battery cable through the battery port. Connect battery cable to battery terminal.

6.5 WIFI Connection (optional)

Inverter provides a WIFI port which can collect data from inverter and transmit it to a monitoring website by WIFI. (Purchase the product from supplier if needed)

➤ WIFI Connection:

Step1. Plug Wi-Fi into the "Wi-Fi" port at the bottom of the inverter.

Step2. Build the connection between the inverter and router.

Step3. Create a user account online. (Please refer to the Stick Logger Quick Guide at the end of this manual for more details).

➤ 6.6 CT Installation instructions

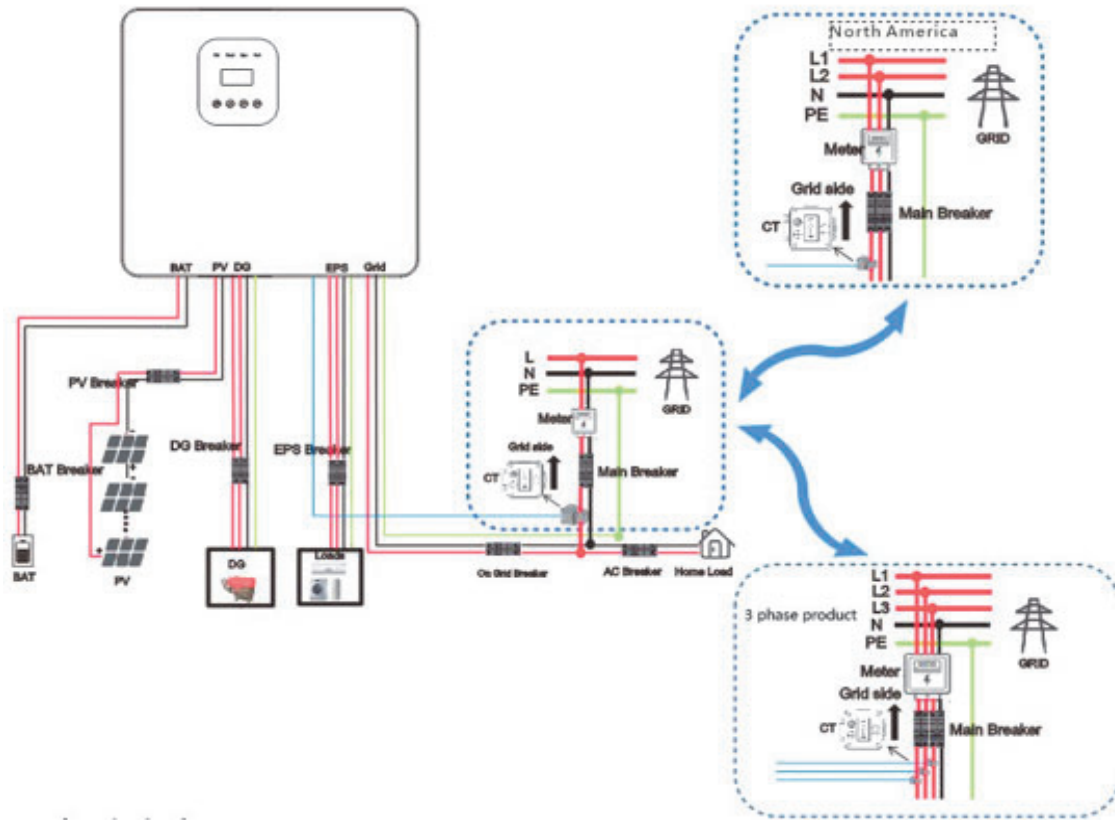

Note: The current transformers should be installed as shown in the figure above. Note that the CT crosses the L line, the CT arrow marks point to power GRID, RJ45 is connected to "Grid Current" in COM. If it is 3 phase products, will be 3pcs CT crosses to "L1, L2, L3" line.

6.7 RSD Installation

The emergency stop button included on the inverter is used to stop the PV modules from passing voltage on the string conductors, leaving them at a safe voltage for first responders to perform work in or on the building. The E-stop is a normally closed (NC) contact. When the button is pressed, the E-stop switches to open. Two 18-22 AWG wires are used for connection between external RSD and inverter. On the inverter end, these conductors are terminated at the 10-pin connector in the middle of the communication board connected to DRY1_1B and DRY1_1, respectively. On the RSD end, the conductor is connected to the back of the contacts.

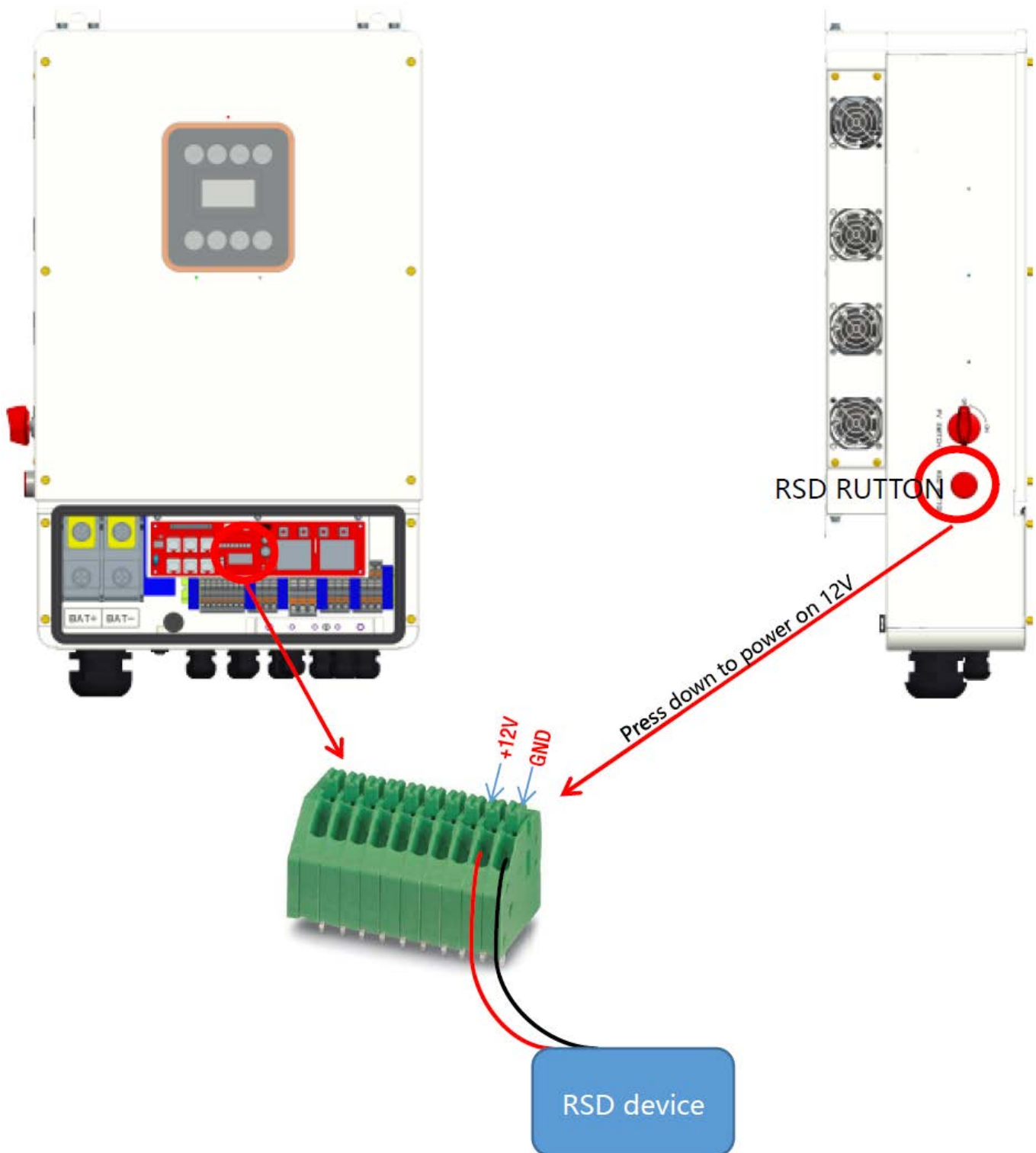

7. LCD Operation

7.1 Control Panel

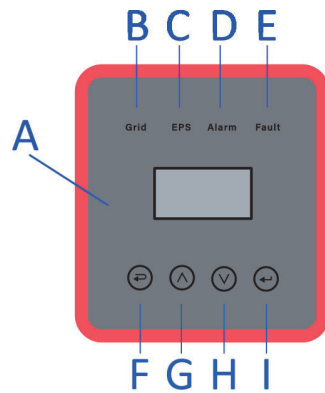

Object	Name	Description
A	LCD	Display the information of the inverter.
B	Indicator LED	Lit in green: The inverter is in grid mode Off: The inverter is in not in grid mode.
C		Lit in green: The inverter is in off grid mode Off: The inverter is in not in off-grid mode.
D		Lit in Yellow: The inverter is in <u>Warning</u> Off: The inverter has no Inverter Warning
E		Lit in red: The inverter is in fault status Off: The inverter has no errors.
F	Function Button	Esc: Return from current interface or function.
G		Up: Move cursor to upside or increase value.
H		Down: Move cursor to downside or decrease value.
I		Enter: Confirm the selection.

7.2 Instructions for LED Indicator

	Grid (Green)	EPS (Green)	Alarm (Yellow)	Fault (Red)
Initialization	off	off	off	off
Stand-by	off	off	off	off
Grid mode	on	off	off	off
Off-Grid	off	on	off	off
Bypass of mains	off	on	on	off
Fault	off	off	off	on

7.3 Work Modes

Inverter provides multiple work modes based on different requirements.

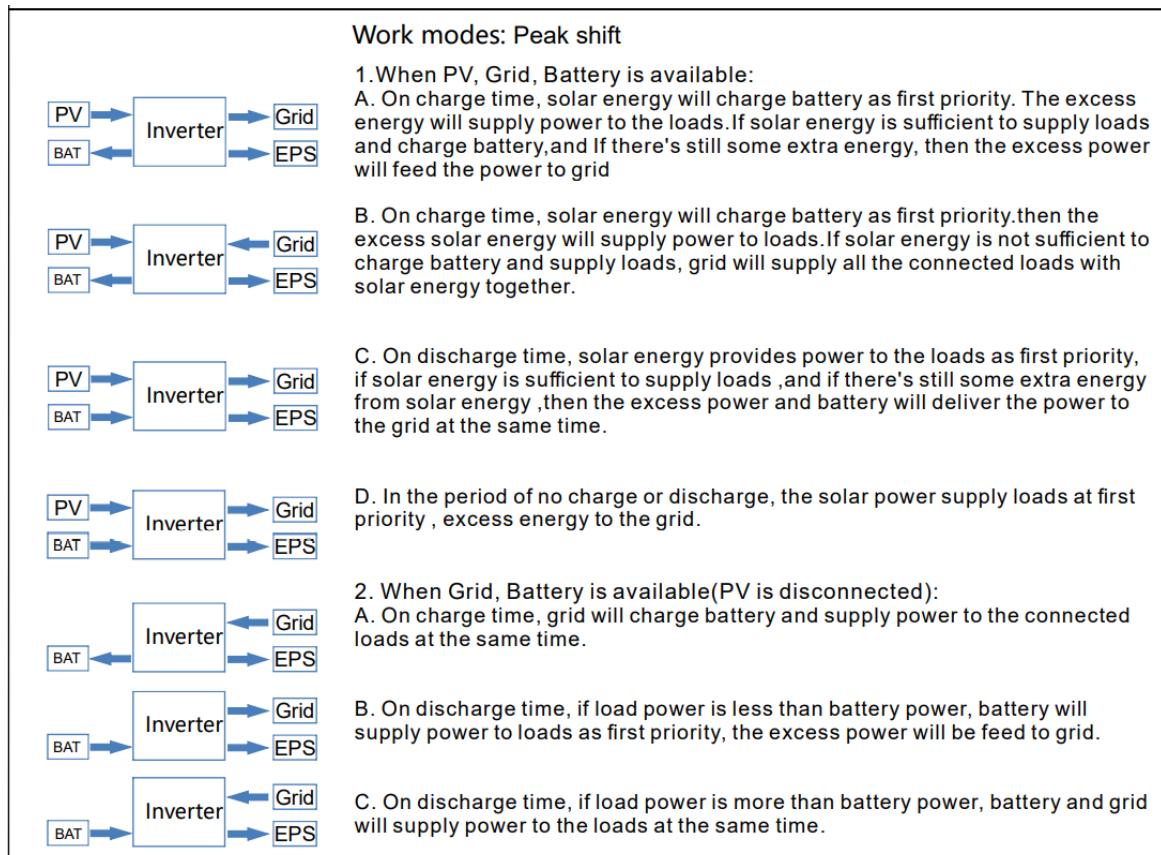
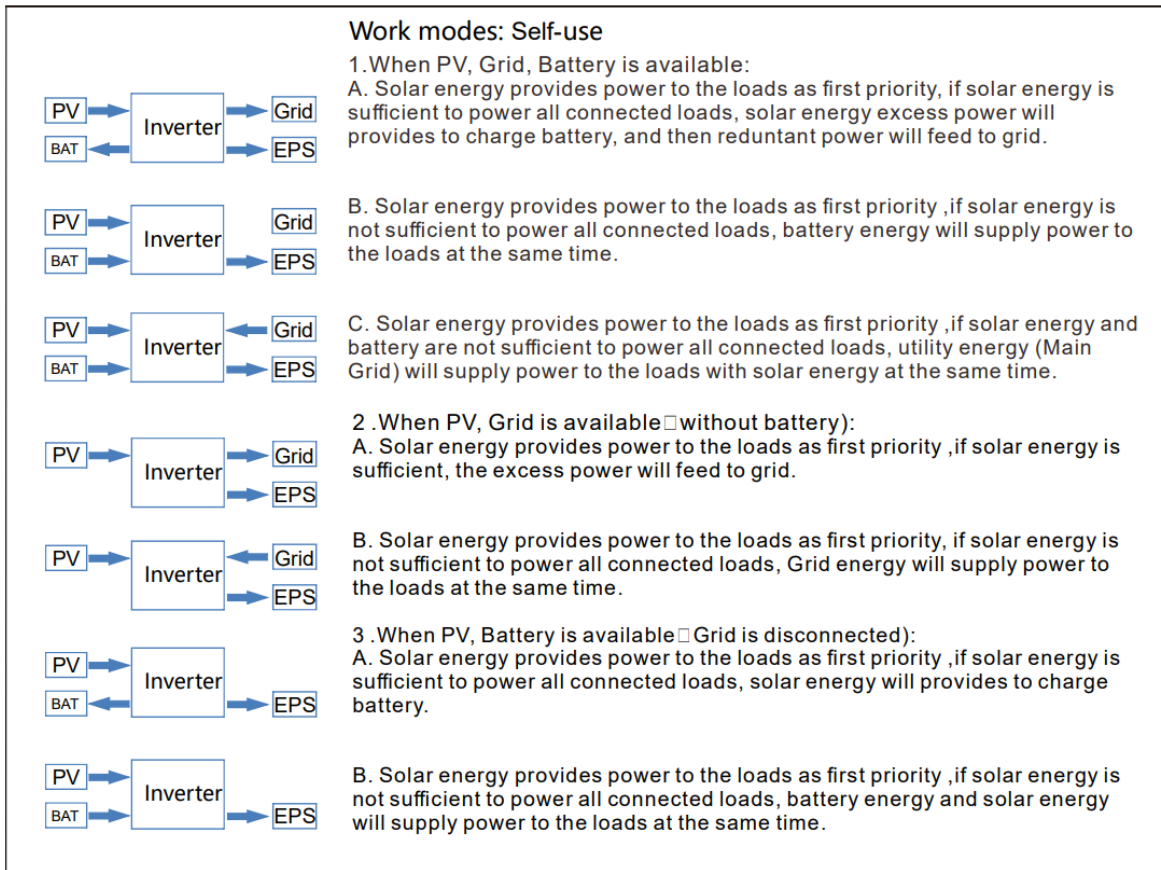

Work modes: Bat priority



1. When PV, Grid, Battery is available:

A. Solar energy will charge battery as first priority, if solar energy is excess, the excess power will supply load. If there's still some extra energy, then the excess power will feed the power to grid .



B. Solar energy will charge battery as first priority, if solar energy is excess, the excess power will supply load. If solar energy is not sufficient to charge battery and supply loads, grid will supply power to loads.



2. When Grid, Battery is available (PV is disconnected):

Grid will supply power to load and charge battery at the same time.

Note!



If set anti-Reverse function allowable, Once on the work mode of Self-use, Peak shift, battery priority, the system will not feed power to grid.

Work modes: FORC OFFGRID



When PV,Grid,Battery is available:

A. When the inverter is in normal operation, grid will be forcibly disconnected and inverter will not charge or discharge to the grid. The load is powered by PV or battery.

B. When the inverter is in the alarm state, the DC to AC circuit is not working and grid will be switched on to supply power to the load.

Caution: Inverter does not support full *Zero Export* capability. Some power may be fed to the grid, especially due to surges.

7.4 Outline For Setting Menu

7.3 Instructions for the use of three modes

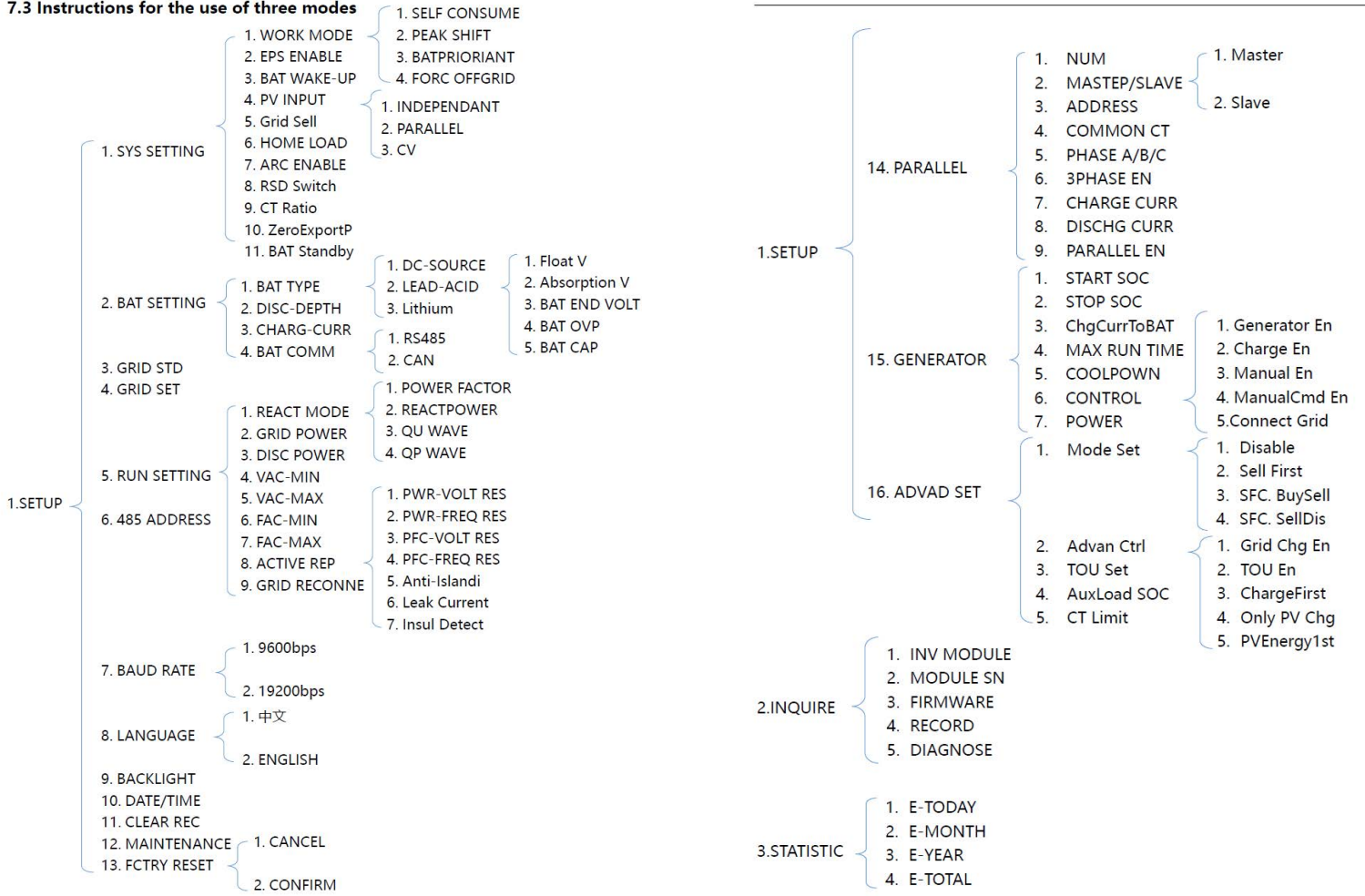

PV input mode and battery type.

Power grid :

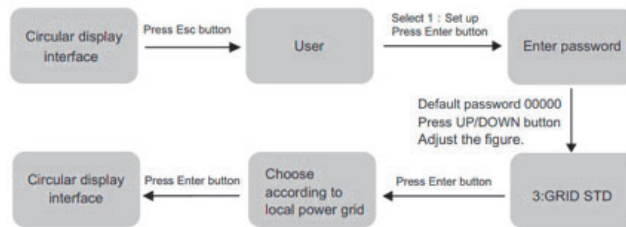

PVinput mode :

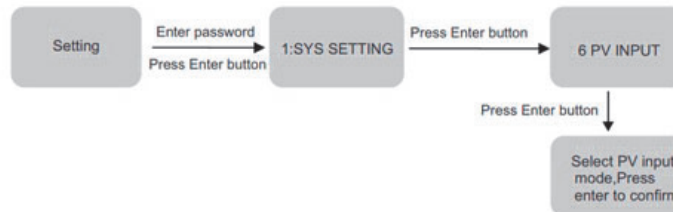



Battery parameters :



8. LCD Operation

8.1 LCD Interface

Error information

Interface	Description
ERROR NO.  02:BatDisconnect 27:BMS Comm.fail	Numbers represent error codes and text is error information. Refer to pages 42-45 for specific contents. NOTE: When there is a lock mark  in the upper right corner of the screen, you cannot turn the page, you need to press Enter to unlock it first.

System setting1

Interface	Description
SYSTEM1 STATE : SELF CSM GRID S T D : UK PV I/P : PARALL	State: Setting of the whole Inverter working mode. Including: SELF CONSUME, PEAK SHIFT, BAT PRIORITY and FORCEOFFGRID Grid standard: Displays the grid standard actually set. PV input mode: The display value is the setting value of PV input type. Including: INDEPENDANT, PARALLEL, CV.

System setting2

Interface	Description
SYSTEM2 BMS Com : CAN Anti Reve : DISA DOD : 80%	BMS Com: Battery Management System communication mode. Including: CAN, RS485. Anti Reve: Displays Whether Inverter isn't allowed to generate electricity to the Grid. Including: DISABLE, ENABLE DOD: Depth of battery discharge.

System setting3

Interface	Description
SYSTEM2 EPS ENABLE : ENAB	EPS ENABLE When the Grid and PV are powered off, Enable the battery to supply power to the load, default option is enabled.

PV1 Input display interface

Interface	Description
PV1 INPUT VOLT: 0.0V CURR: 0.00A POWER: 0W	PV1 input real-time voltage, current and power.

PV2 Input display interface

Interface	Description								
<table border="1"> <tr> <td colspan="2">PV2 INPUT</td> </tr> <tr> <td>VOLT:</td> <td>0.0V</td> </tr> <tr> <td>CURR:</td> <td>0.00A</td> </tr> <tr> <td>POWER:</td> <td>0W</td> </tr> </table>	PV2 INPUT		VOLT:	0.0V	CURR:	0.00A	POWER:	0W	PV2 input real-time voltage, current and power.
PV2 INPUT									
VOLT:	0.0V								
CURR:	0.00A								
POWER:	0W								

PV3 Input display interface

Interface	Description								
<table border="1"> <tr> <td colspan="2">PV3 INPUT</td> </tr> <tr> <td>VOLT:</td> <td>0.0V</td> </tr> <tr> <td>CURR:</td> <td>0.00A</td> </tr> <tr> <td>POWER:</td> <td>0W</td> </tr> </table>	PV3 INPUT		VOLT:	0.0V	CURR:	0.00A	POWER:	0W	PV3 input real-time voltage, current and power.
PV3 INPUT									
VOLT:	0.0V								
CURR:	0.00A								
POWER:	0W								

PV4 Input display interface

Interface	Description								
<table border="1"> <tr> <td colspan="2">PV4 INPUT</td> </tr> <tr> <td>VOLT:</td> <td>0.0V</td> </tr> <tr> <td>CURR:</td> <td>0.00A</td> </tr> <tr> <td>POWER:</td> <td>0W</td> </tr> </table>	PV4 INPUT		VOLT:	0.0V	CURR:	0.00A	POWER:	0W	PV4 input real-time voltage, current and power.
PV4 INPUT									
VOLT:	0.0V								
CURR:	0.00A								
POWER:	0W								

DC Voltage interface

Interface	Description								
<table border="1"> <tr> <td colspan="2">DC VOLTAGE</td> </tr> <tr> <td>VpBUS:</td> <td>235.0V</td> </tr> <tr> <td>VnBUS:</td> <td>235.0A</td> </tr> <tr> <td>LeakCur:</td> <td>0mA</td> </tr> </table>	DC VOLTAGE		VpBUS:	235.0V	VnBUS:	235.0A	LeakCur:	0mA	<p>VpBUS: Real-time voltage of bus capacitor of the machine.</p> <p>VnBUS: Real-time voltage of bus capacitor of the machine.</p> <p>LeakCur: Real-time leak current of the machine.</p>
DC VOLTAGE									
VpBUS:	235.0V								
VnBUS:	235.0A								
LeakCur:	0mA								

Battery interface

Interface	Description								
<table border="1"> <tr> <td colspan="2">BATTERY</td> </tr> <tr> <td>VOLT:</td> <td>0.0V</td> </tr> <tr> <td>CURR:</td> <td>0.0 A</td> </tr> <tr> <td>STA:</td> <td></td> </tr> </table>	BATTERY		VOLT:	0.0V	CURR:	0.0 A	STA:		Battery real-time voltage, current.
BATTERY									
VOLT:	0.0V								
CURR:	0.0 A								
STA:									

Battery current interface

Interface	Description
BATTERY INFO TYPE: Lithium TEMP: 26°C SOC: 30%	TYPE: Battery type:(lead acid, lithium battery) TEMP: Battery temperature. SOC: Percentage of battery surplus capacity

Battery current interface

Interface	Description
BMS PRMETER CHAR VOL: 0.0V CHARGE: 50A DISCHA: 50A	CHAR VOL: Battery charging or discharging voltage. CHARGE: Battery charging current. DISCHA: Battery discharging current.

Grid-connected

Interface	Description
GRID: 0.00Hz L1: 0.0V 0.00A L2: 0.0V 0.00A	GRID FREQ: Grid real-time frequency. L1: Grid-L1 real-time voltage. CT real-time current L2: Grid-L1 real-time voltage. CT real-time current CT Current sensor accessories

Inverter Frequency

Interface	Description
INV: 0.00Hz L1: 0.0V 0.00A L2: 0.0V 0.00A	INV FREQ: Grid real-time frequency. L1: INV-L1 real-time voltage. INV-L1 real-time current. L2: INV-L2 real-time voltage. INV-L2 real-time current.

LOAD

Interface	Description
LOAD: L1: 0.0V 0.00A L2: 0.0V 0.00A	L1: LOAD-L1 real-time voltage. LOAD-L1 real-time current. L2: LOAD-L2 real-time voltage. LOAD-L2 real-time current.

ON GRID POWER

Interface	Description						
<table border="1"> <tr> <td colspan="2">POWER</td> </tr> <tr> <td>GRID L1:</td> <td>0W</td> </tr> <tr> <td>GRID L2:</td> <td>0W</td> </tr> </table>	POWER		GRID L1:	0W	GRID L2:	0W	GRID L1: Grid -L1 power. GRID L2: Grid -L2 power.
POWER							
GRID L1:	0W						
GRID L2:	0W						

INVERTER POWER

Interface	Description						
<table border="1"> <tr> <td colspan="2">POWER</td> </tr> <tr> <td>INV L1:</td> <td>0W</td> </tr> <tr> <td>INV L2:</td> <td>0W</td> </tr> </table>	POWER		INV L1:	0W	INV L2:	0W	INV: INV-L1 power. INV: INV-L2 power.
POWER							
INV L1:	0W						
INV L2:	0W						

LOAD POWER PER

Interface	Description						
<table border="1"> <tr> <td colspan="2">LOAD POWER PER</td> </tr> <tr> <td>L1:</td> <td>0W 0%</td> </tr> <tr> <td>L2:</td> <td>0W 0%</td> </tr> </table>	LOAD POWER PER		L1:	0W 0%	L2:	0W 0%	L1: Load- L1 power percentage. L2: Load- L2 power percentage.
LOAD POWER PER							
L1:	0W 0%						
L2:	0W 0%						

POWER

Interface	Description						
<table border="1"> <tr> <td colspan="2">POWER</td> </tr> <tr> <td>PV I/P:</td> <td>0W</td> </tr> <tr> <td>BAT:</td> <td>0W</td> </tr> </table>	POWER		PV I/P:	0W	BAT:	0W	PV I/P: PV power. BAT: BAT power.
POWER							
PV I/P:	0W						
BAT:	0W						

Temperature

Interface	Description								
<table border="1"> <tr> <td colspan="2">TEMPERATURE</td> </tr> <tr> <td>INVER:</td> <td>0°C</td> </tr> <tr> <td>DCDC:</td> <td>0°C</td> </tr> <tr> <td>INSIDE:</td> <td>0°C</td> </tr> </table>	TEMPERATURE		INVER:	0°C	DCDC:	0°C	INSIDE:	0°C	INVER: INV Temperature. DCDC: DCDC Temperature. INSIDE: Internal ambient temperature of the machine.
TEMPERATURE									
INVER:	0°C								
DCDC:	0°C								
INSIDE:	0°C								

State

Interface	Description								
<table border="1"> <tr> <td colspan="2">STATE</td> </tr> <tr> <td>SYS:</td> <td>STANDBY</td> </tr> <tr> <td>INV:</td> <td>STANDBY</td> </tr> <tr> <td>DCDC:</td> <td>STANDBY</td> </tr> </table>	STATE		SYS:	STANDBY	INV:	STANDBY	DCDC:	STANDBY	System information: Display complete machine status information, including: Initialization, Standby, PV grid connection, Grid connection of battery, Hybrid power supply, etc. INV: Displays the inverter status information. DCDC: Displays charging and discharging status information
STATE									
SYS:	STANDBY								
INV:	STANDBY								
DCDC:	STANDBY								

8.2 SETTING

State

Interface	Description
USER →1: SETUP 2: INQUIRE 3: STATISTIC	SETUP: Press Enter to user settings interface. INQUIRE: Query machine model, serial number, software version. STATISTIC: View machine run statistics.

SET Password

Interface	Description
PASSWORD INPUT: XXXXX	Enter the password required for setting. The default password is "00000". Press the Up or Down keys to adjust the number, press the Enter key to move the cursor forward, and press the Esc key move the cursor backward.

Setup

Interface	Description
SETUP →1:SYS SETTING 2:BAT SETTING 3:GRID STD 4:GRID SETTING 5:RUN SETTING 6:485 ADDRESS 7:BAUD RATE 8:LANGUAGE 9:BACKLIGHT 10:DATE/TIME 11:CLEAR REC 12:MAINTENANCE 13:FCTRY RESET 14:PARALLEL 15:GENE RATOR 16:ADVAN SET	This interface is used for various information inquiry options. Press the Up/Down button to make the corresponding selection. Press Enter button to enter the selected menu. Press ESC button return to the user interface. (Refer to 8.2.1). There are 16 options in total.

System setting

Interface	Description
SYS SETTING → 1: WORK MODE 2: EPS ENABLE 3: BAT WAKE-UP 4: PV INPUT 5: Grid Sell 6: HOME LOAD 7: ARC Enable 8: E-STOP 9: CT Ratio 10: ZeroExportP 11: BAT Standby	This interface is used to access system information. Press Up/Down button to move corresponding options. Press Enter to enter the selected menu. Press ESC button to return to the setting interface. There are 11 options in total.

Work mode

Interface	Description
WORK MODE → 1:SELFCONSUME 2:PEAK SHIFT 3:BAT PRIORITY 4:FORC OFFGRID	This interface is used to select the working mode. Press ESC button return to setting interface. (Refer to 3.3)

Peak shift work time

Interface	Description
WORK MODE 1:SELFCONSUME → 2:PEAK SHIFT 3:BAT PRIORITY	This interface is used to select the working mode. Press ESC button return to setting interface. (Refer to 3.3). Select the peak shift mode, you also need to set the charge and discharge time
WORKTIME* → 1:TIME 1 2:TIME 2 3:TIME 3	It's allowed to set Three charging and discharging periods. When setting the time, ensure that the time of the inverter is the local time. Press Enter to enter the next menu.
CHR START1 00:00 CHR END1 00:02 DIS START1 00:03 DISC END1 23:59	This interface is used to adjust the time of peak load shifting. There are three time periods you can set. Press Up/Down button to move the corresponding options. Press Enter to enter the selected menu. Press Esc button to return to the working mode interface.

EPS enable

Interface	Description
<p>EPS ENABLE</p> <p>1: DISABLE</p> <p>→ 2: ENABLE</p>	<p>When the Grid and PV are powered off, Enable the battery to supply power to the load, default option is enabled.</p>

Battery wake-up

Interface	Description
<p>WAKE-UP EN</p> <p>→ 1: DISABLE</p> <p>2: ENABLE</p>	<p>When the battery is low and the battery relay has been disconnected, the inverter will send instructions to the battery forcibly sucking relay by BMS, and the inverter will charge.</p> <p>The default option is disabled. (Partial battery support)</p>

REMOTE CTRL

Interface	Description
<p>REMOTE CTRL</p> <p>→ 1: DISABLE</p> <p>2: ENABLE</p>	<p>Remote control the inverter on or off. (Subsequent support...)</p> <p>The default option is disabled.</p>

START DELAY

Interface	Description
<p>START-UP DELAY</p> <p>INPUT: 60</p> <p>UNIT: SEC</p>	<p>The input value ranges from 20 to 300, which varies with different standards.</p>

PV INPUT MODE

Interface	Description
<p>INPUT MODE 1.</p> <p>→ INDEPENDENT</p> <p>2. PARALLEL</p> <p>3. CV</p>	<p>Setup of PV Input mode.</p> <p>The factory setting by default is Independent, when parallel input is set to be stand-alone mode, PV power will be imbalanced.</p> <p>Parallel mode is commonly used in test, two or four road PV in parallel.</p> <p>CV : Constant voltage model</p>

Grid Sell

Interface	Description
Grid Sell → 1.YES 2.NO	Grid Sell: Whether the inverter is allowed to sell electricity to the grid. The default option is Allow, which means that the inverter can generate electricity to the grid.

Anti Reverse

Interface	Description
Anti Reverse → 1. DISABLE 2.ENABLE	Anti Reverse: Whether Inverter isn't allowed to generate electricity to the Grid. The default option is disabled, which means the inverter is allowed to generate electricity to the Grid.

ARC ENABLE

Interface	Description
-ARC- 1. →DISABLE 2.ENABLE	Enable or disable arc pull function detection.

E-Stop ENABLE

Interface	Description
BUTTON ENABLE → 1. DISABLE 2.ENABLE	After powering on, press the button to run the inverter. If the button is not pressed, the button will not take effect when the machine is disabled in standby.

CT Ratio

Interface	Description
CT Ratio → 1000:1	CT proportional parameters. Depending on the actual CT ratio parameter, the factory default is 1000:1.

Zero Export Power

Interface	Description
ZeroExportP → Input: 0.0 W	Adjust static working parameter values. In self consume mode, ZeroExportP set 200W, buy 200W power from grid. A positive input takes power from the grid, and a negative input sells power to the grid.

BAT Standby

Interface	Description
BAT Standby → 1.DISABLE 2.ENABLE	When the battery capacity is insufficient, the inverter enters the standby state.

BATTERY SETTING

Interface	Description
BAT SETTING → 1.BAT TYPE 2.DISC-DEPTH 3.CHARG-CURR 4.BAT-COMM	This interface is used to select battery parameters. Press Up/Down button to move corresponding options; Press Enter button to enter the selected menu; Press ESC button to return to setting interface.

BATTERY TYPE

Interface	Description
BAT TYPE 1.DC-SOURCE → 2.LEAD-ACID 3.Lithium	This interface is used to select battery type. Press Up/Down button to move corresponding options; Press Enter button to enter the selected menu. Select the LEAD-ACID enter button to enter LEAD-ACID interface;

Lead-acid battery parameter

Interface	Description
LEAD-ACID →1.CHARG-VOLT 2.BAT END VOLT 3:BAT OVP 4:BAT CAP	This interface is used to select LEAD-ACID battery parameter. Press Up/Down button to move corresponding options; Press Enter button to enter the selected menu;
CHARGE VOLT INPUT: 55.0 V UNIT: V	This interface is used to set the lead acid battery charging voltage.

Interface	Description
BAT END VOLT INPUT: 043.0 UNIT: V	This interface is used to set the lead acid battery discharging voltage.
BAT OVP INPUT: 058.0 UNIT: V	This interface is used to set the lead acid battery Charge protection voltage.
BAT CAP INPUT: 0100 UNIT: AH	This interface is used to set the lead acid Battery capacity.

DISC-DEPTH

DISC DEPTH Grid DOD: 080% OFF Grid DOD: 080% Return: 020%	Grid DOD/ OFF Grid DOD: When the battery discharge is higher than the set parameter, the inverter generates a battery low voltage alarm. Return: When a low-voltage alarm is generated, the alarm is cleared if the battery charge is higher than the specified amount.
--	--

BAT-COMM

Interface	Description
BAT-COMM 1.RS485 →2.CAN	This interface is used to select battery communication. Press Up/Down button to move corresponding options; Press Enter button to enter the selected menu. The default option is CAN.

Grid standard

Interface	Description
GRID STD 1.AU 2.AU-W 3.NZ 4.UK 5.VDE 6.KR 7.PHI 8.CN → 9.US-CA 10.JP 11.CUSTOM	This interface is used to select Grid standard. Press Up/Down button to move corresponding options; Press Enter button to enter the selected menu. 1:AU--(Australia) 2:AU-W—(Western Australia) 3:NZ-- New Zealand 4: UK--United Kingdom 5: VDE—Germany 6:KR—Korea 7: PHI— Philippines 8:CN—China 9:US-CA—America 10:JP—Japan 11: CUSTOM--User defined

Grid set

	Description
GRID SET → 1:Single Phase 2:Split Phase 3:US 208V 4:JP 120V	Single Phase : 220V Single-phase. Split Phase : 120/240V Split-phase. US 208V : 120/208V Split-phase. JP 120V : 120V Single-phase.

RUN SETTING

Interface	Description
RUN SETTING 1.REACT MODE → 2.GRID POWER 3.DISC POWER 4.VAC-MIN 5.VAC-MAX 6.FAC-MIN 7.FAC-MAX 8.ACTIVEREP 9.GRID RECONN	This interface is used to select run setting. Press Up/Down button to move corresponding options; Press Enter button to enter the selected menu. Factory default Settings, please consult the distributor for modification. 1. REACT MODE: Used to select reactive power control mode. 2. GRID POWER: When the inverter is connected to the grid, it can be used to set the maximum discharge current provided by the whole inverter to the grid. 3. DISC POWER: When the inverter is connected to the grid, it can be used to set the maximum discharge current provided by the battery to the grid.

REACT MODE

Interface	Description
<p>RUN SETTING →1.REACT MODE 2.GRID POWER 3.DISC POWER</p>	<p>This interface is used to select react mode. Press Up/Down button to move corresponding options; Press Enter button to enter the selected menu. (For specific country if required by the local grid.)</p>
<p>REACT MODE →1.POWER FACTOR 2.REACT POWER 3.QU WAVE 4.QP WAVE</p>	<p>POWER FACTOR: Active Power/ Apparent Power a ratio of, used to control reactive power. REACT POWER: Direct reactive power control.</p> <p>QU WAVE: Voltage-reactive curve. QP WAVE: Active power-reactive power curve. (These two functions are not available on the screen, please contact the distributor if you need to use them.)</p>
<p>POWER FACTOR INPUT: C1.00</p>	<p>The input value should range between L0.80 and L0.99 or C0.8 and C1.00.</p>
<p>REACT POWER INPUT: +00%</p>	<p>The input value should range between -60% and +60%, which varies with the standard.</p>

GRID POWER

Interface	Description
<p>GRID PERCENT INPUT: 100%</p>	<p>The input value is power percent of grid.</p>

DISCHARGE POWER

Interface	Description
<p>DISC PERCENT INPUT: 100%</p>	<p>The input value is power percent of battery discharge.</p>

VAC-MIN

Interface	Description
<p>GRID VOLT LOW INPUT: 176 UNIT: V</p>	<p>The input value of Grid low voltage.</p>

VAC-MAX

Interface	Description
<p>GRID VOLT HIGH INPUT: 270 UNIT: V</p>	The input value of Grid high voltage.

GRID FREQUENCY-MIN

Interface	Description
<p>GRID FREQ LOW INPUT: 42.0 UNIT: Hz</p>	The input value of Grid low frequency.

GRID FREQUENCY-MAX

Interface	Description
<p>GRID FREQ HIGH INPUT: 58.0 UNIT: Hz</p>	The input value of Grid high frequency.

ACTIVE REF.

Interface	Description
<p>ACTIVE Type 1.PWR-VOLT RES 2.PWR-FREQ RES 3.PFC-VOLT RES 4.PFC-FREQ RES 5. Anti-Islandi 6.Leak Current 7.Insul detect</p>	<p>1.PWR-VOLT RES: Generation voltage response. When the grid voltage is abnormal, the active power is limited, and the function is enabled when required by the national grid standard.</p> <p>2.PWR-FREQ RES: Generation frequency response. When the power grid frequency is abnormal, the active power will be limited, and the function will be enabled if required by the national power grid standard.</p> <p>3.PFC-VOLT RES: Charge voltage response. When the grid voltage is abnormal, the charging power will be limited, and the function will be enabled if required by the national grid standards.</p> <p>4.PFC-FREQ RES: Charge frequency response. When the power grid frequency is abnormal, the charging power will be limited, and the function will be enabled if required by the national power grid standard.</p> <p>5.Anti-Island: Anti-Islanding(The default option is enable) When the grid goes down, inverter will detect the loss of power and disconnect from the grid within milliseconds. It prevents your solar panels from feeding electricity into a downed power line.</p> <p>6.Leak Current: Leak current detect (The default option is enable).</p> <p>7.Insul detect: Insulation detect (The default option is enable). When the insulation detection function is enabled in the grid-connected state, the insulation detection is performed once a day when the photovoltaic energy comes in, and the inverter switches to the By-pass band load. If the inverter is off-grid, the output will be disconnected during insulation detect and the load will stop working.</p>

485 Address

Interface	Description
<div style="border: 1px solid black; padding: 5px;"> <p>485 ADDRESSES INPUT: 1</p> </div>	This interface is used to select 485 addresses.

BAUD RATE

Interface	Description
<div style="border: 1px solid black; padding: 5px;"> <p>SELECT →1.2400 bps 2.4800 bps 3.9600 bps</p> </div>	This interface is used to select 485 baud rates.

LANGUAGE

Interface	Description
<div style="border: 1px solid black; padding: 5px;"> <p>LANGUAGE 1.Chinese →2. English</p> </div>	This interface is used to select language.

BACKLIGHT

Interface	Description
<div style="border: 1px solid black; padding: 5px;"> <p>LIGHT TIME INPUT: 20 UNIT: SEC</p> </div>	This interface is used to set light time.

DATE/TIME

Interface	Description
<div style="border: 1px solid black; padding: 5px;"> <p>DATE/TIME DATE: 2021-12-25 TIME: 22:30:00 WEEK: Saturday</p> </div>	This interface is used to set date and time.

Clear history

Interface	Description
<p>DEL REC →1. CANCEL 2. CONFIRM</p>	<p>This interface is used to clear operation history.</p>

PASSWORD

Interface	Description
<p>PASSWORD OLD: XXXXX NEW: XXXXX CONFIRM: XXXXX</p>	<p>This interface is used to set password. Default Password is 00000</p>

MAINTENANCE

Interface	Description
<p>PASSWORD INPUT: XXXXX</p>	<p>This interface is used to enter maintenance. Default Password is 99999</p>

FACTORY RESET

Interface	Description
<p>FACTORY RESET →1. CANCEL 2. CONFIRM</p>	<p>This interface is used to reset the inverter.</p>

INQUIRE

Interface	Description
<p>INQUIRE →1.INV MODULE 2.MODULE SN 3.FIRMWARE 4.RECORD 5.DIAGNOSE</p>	<p>Press Up/Down button to move corresponding options; Press Enter button to jump to the selected menu. Press ESC button to return to another interface.</p>

INVERTER MODULE

Interface	Description
<p>MODEL 8K</p>	<p>This interface shows inverter model.</p>

MODULE SN

Interface	Description
<p>S / N GUID: XXXXXXXX XXXXXXXXXXXXXXXX SN:FXXXXXXXXXXXXX</p>	<p>This interface shows module SN.</p>

FIRMWARE

Interface	Description
<p>FIRMWARE ARM: V1.XX.XX DSP: V1.XX.XX</p>	<p>This interface shows Software version.</p>

RUNNING RECORDS

Interface	Description
<p>REC (01) 02: Batdisconnect UP: 12-25 23:00 DOWN:</p>	<p>This interface show running recodes.</p>

DIAGNOSE

Interface	Description
DIAGNOSE 000000 000000 000000 000000 000000 000000	Factory internal use.

STATISTIC

Interface	Description
STAT. → 1.TIME STAT. 2.CONNE.TIMES 3.PEAK POWER 4.E-TODAY 5.E-MONTH 6.E-YEAR 7.E-TOTAL	This interface shows inverter operation statistics. <ol style="list-style-type: none"> 1. Inverter operation and Grid-connection time statistic. 2. Inverter Grid-connection times statistic. 3. Displays power peak in history and for the day. 4. Displays statistic for the day (KWH). 5. Displays statistic for the month (KWH). 6. Displays statistic for the year (KWH). 7. Displays statistic of the inverter (KWH).

9. Fault diagnosis and solutions

This inverter is easy to maintain. When you encounter the following problems, please refer to the Solutions below, and contact the local distributor if the problem remains unsolved. The following table lists some of the basic problems that may occur during the actual operation as well as their corresponding basic solutions.

Fault diagnosis table

Content	Codes	Solutions
Discharge Over Current	00 29	(1) Wait one minute for the inverter to restart. (2) Check whether the load is in compliance with the specification. (3) Cut off all the power and shut down all the machines; disconnect the load and plug in to restart machines,
Over Load	01	(1) Check whether the load is in compliance with the maximum power of the machine. (2) Cut off all the power and shut down all the machines; disconnect the load and plug in to restart machines, then check whether the load is short circuited if the fault has been eliminated. (3) Contact customer service if error warning continues.
Battery Disconnect	02	(1) Check if the battery is not connected. (2) Check if battery wiring port is open circuited. (3) Contact customer service if error warning continues.
Battery Under Voltage	03 04 26	(1) Check if the battery is in line with the presetting, If so, power off and restart. (2) Check if the grid is powered down. If the power is off, wait for the grid to powered up, the grid will automatically charge the battery. (3) Contact customer service if error warning continues.
Battery Over Voltage	05 27	(1) Check if the battery is in line with the presetting, If so, power off and restart. (2) Contact customer service if error warning continues.

grid low voltage	06	(1) Check if the grid is abnormal. (2) Restart the inverter and wait until it functions normally. (3) Contact customer service if error warning continues.
grid over voltage	07	(1) Check if the grid is abnormal. (2) Restart the inverter and wait until it functions normally. (3) Contact customer service if error warning continues.
grid low frequency	08	(1) Check if the grid is abnormal. (2) Restart the inverter and wait until it functions normally. (3) Contact customer service if error warning continues.
grid over frequency	09	(1) Check if the grid is abnormal. (2) Restart the inverter and wait until it functions normally. (3) Contact customer service if error warning continues.
GFCI over	10	(1) Check PV string for direct or indirect grounding phenomenon. (2) Check peripherals of machine for current leakage. (3) Contact the local inverter customer service if fault remains
Solar disconnected	11	(1) PV is not connected. (2) PV switch is not closed. (3) Check PV availability.
Grid CT Reverse	12	(1) Check whether the CT is connected in the correct direction. (2) Contact customer service if error warning continues.
bus under voltage	13	(1) Check the input mode setting is correct. (2) Restart the inverter and wait until it functions normally. (3) Contact customer service if error warning continues.
bus over voltage	14	(1) Check the input mode setting is correct. (2) Restart the inverter and wait until it functions normally. (3) Contact customer service if error warning continues.
inverter over current	15	(1) Restart the inverter and wait until it functions normally. (2) Contact customer service if error warning continues.
charge over current	16	(1) Check if battery wiring is short circuited. (2) Check if charging current is in compliance with presetting. (3) Contact customer service if error warning continues.

bus voltage oscillation	17	(1) Cut off all the power and shut down all the machines and restart. (2) Contact customer service if error warning continues.
inverter under voltage	18	
inverter over voltage	19	
Inverter Frequency	20	
Abnormal		
environment temperature high	21	(1) Cut off all the power of the machine and wait one hour, then turn on the power of the machine. (2) Contact customer service if error warning continues.
battery over temperature	23	(1) Disconnect the battery and reconnect it after an hour. (2) Contact customer service if error warning continues.
battery under temperature	24	(1) Check the ambient temperature near the battery to see if it meets the specifications. (2) Contact customer service if error warning continues.
Battery Cell Unbalanced	25	(1) Break the grid, use the battery to supply power to the load, reconnect the grid side switch after half an hour, wait another half an hour and check the fault status again.
charge over current	28	(1) Check if battery wiring port is short circuited. (2) Check if charging current is in compliance with presetting. (3) Contact customer service if error warning continues.
bus soft fail inv soft fail	32	(1) Restart the inverter and wait until it functions normally. (2) Contact customer service if error warning continues.
bus short inv short fan fault	33	
Bus Relay Fault Grid Relay	34	
Fault BACK-UP rly fault gfc	35	
fault	36	
Load Ct fault OffgridRlyFal system	38	
fault	39	
	40	
	41	
	42	
	44	
	45	
pviso low	37	(1) Check if the PE line is connected to the inverter and is connected to the ground. (2)Contact customer service if error warning continues.

PV short	43	(1) Restart the inverter and wait until it functions normally. (2) Disconnect the PV input, restart the inverter and wait until it functions normally.
battery reverse polarized	46	(1) Check if the inverter battery positive and negative connection is correct. (2) Contact customer service if error warning continues.

10. Inverter Parallel Guide

10.1 Parallel System Diagram

Multiple inverters can be installed together to deliver more power. When AC loads are present, all units effectively share the load. The system diagram is as follows.

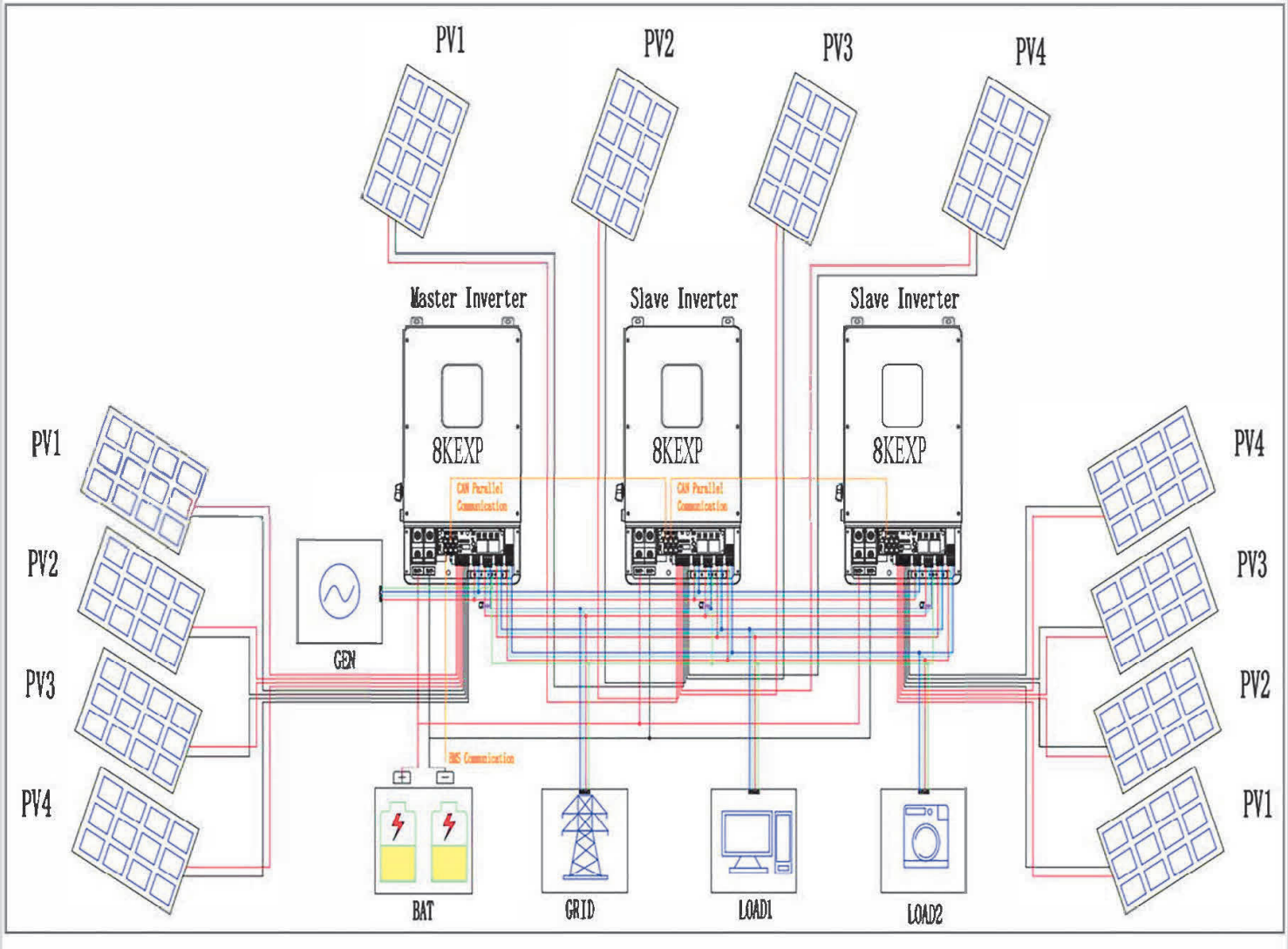

10.2 Parallel Communication Cable Connection

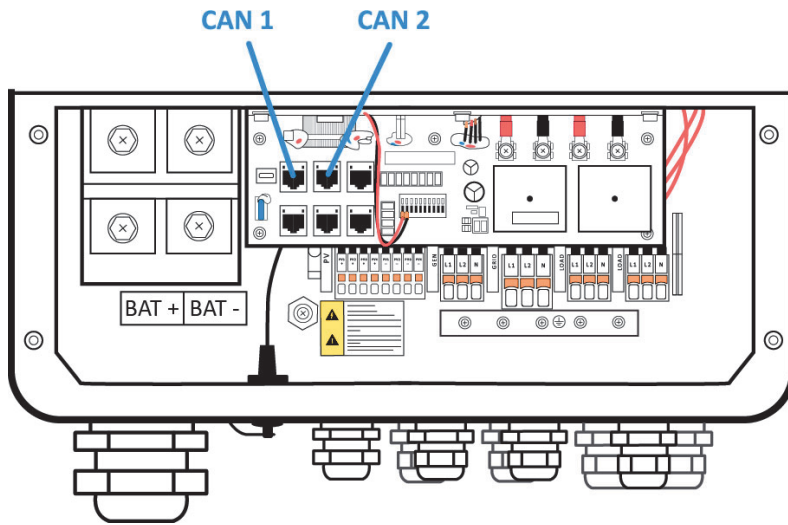

For parallel communication, CAT 5 cables are needed. When using common batteries, BMS cable needs to be connected to the master unit. The inverter shares the BMS information by inter-unit parallel communication cable.

10.3 Parallel Operation Notes

- 1) Make sure all the units in parallel are with the same software version. USER->INQUIRE->FIRMWARE

FIRMWARE	
ARM:	V1.XX.XX
DSP:	V1.XX.XX

- 2) Please check the diagram above. The common battery use is supported by default for maximizing the system efficiency. The BMS cable should be connected to the master inverter.

- 3) Connect the loads of the two inverters together first. It should be noted that the grid power line and the load line of the two inverters should be roughly the same length.

- 4) Make sure the CT Limiter sensor is installed properly. If the load is connected outside the inverter, user needs to choose a common CT and make sure the CT ratio is right (the default 90A CT ratio is 1:1000, no need to change). The common CT is only needed to be connected to the master inverter. Please install CT on every unit's incoming electrical service wire on L1 and L2(see diagram) when choosing independent CT.

- 5) Please check the master and slave setting by screen and make sure all the setting are same.

10.4 Parallel System Setting

The parallel setting page can be accessed in the following steps in the screen:
 USER->1. SETUP->PASSWORD CHECK->15.parallel

10.4.0 Setting

Interface	Description
Parallel. →1.NUM. 2.MASTER/SLAVER 3. ADDRESS 4. COMMON BAT 5. COMMON CT 6. PHASE A/B/C 7.DISCHARGE CURR 8.CHARGE CURR 9.PARALLEL EN	This interface shows parallel setting. 1. Total numbers of the inverters. 2. In a parallel system, the master unit broadcasts the BMS and other information to the slavers. Make sure only one unit is configured as master. 3. Local unit address (1-8). 4. Common battery or independent battery. 5. Common CT Enable 6. Local phase of unit for three-phase installation. (Reserved function) 7. DISCHARGE CURR, Total battery discharge current command, only be settable in master unit in parallel mode. 8. CHARGE CURR, Total battery charge current command, only be settable in master unit in parallel mode. 9. PARALLEL EN, Enable/Disable the parallel function

10.4.1 Parallel Error information

Interface	Description
ERROR NO.  11: parallel fail	A parallel warning may occur because of the following reasons: 1. Wrong setup of the parallel num. 2. Wrong inter-unit parallel communication cable. 3. Wrong setup of the unit address.

Stick Logger Quick Guide

Model: LSW-3/LSW-3-C

Notice:

Please read this manual carefully before using products and keep it in the place where O&M providers can easily find.

Due to product upgrade and other factors, the content of this manual might change from time to time. Please take actual product as standard and get latest manual from www.solarman.cn or sales. Unless otherwise agreed herein, this manual will only be used as guidance. Any statement, information or suggestion in this manual will not take any form of responsibility.

Without written permission, any content of this document (partly or entirely) cannot be extracted, copied or transmitted in any form by any company or individual.

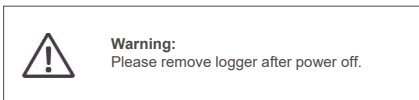

Download APP

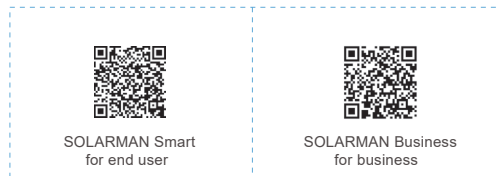

iPhone: Search "SOLARMAN Smart" in Apple Store.

Android: Search "SOLARMAN Smart" in Google Play.

1. Stick Logger Installation

Type 1

Step1: Assemble logger to the inverter communication interface as shown in the diagram.

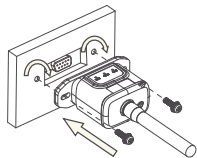

Type 2

Step1: Assemble logger to the inverter communication interface as shown in the diagram.

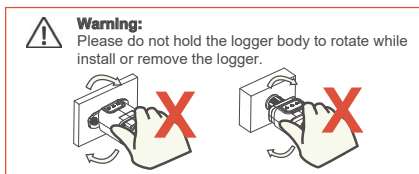
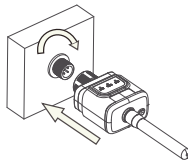

2. Logger Status

2.1 Check Indicator light

Lights	Implication	Status Description(All lights are single green lights.)
NET	Communication with router	1.Light off: Connection to the router failed. 2.On 1s/Off 1s(Slow flash): Connection to the router succeeded. 3.Light keeps on: Connection to the server succeeded. 4.On 100ms/Off 100ms(Fast flash): Distributing network fast.
COM	Communication with inverter	1.Light keeps on: Logger connected to the inverter. 2.Light off: Connection to the inverter failed. 3.On 1s/Off 1s(Slow flash): Communicating with inverter.
READY	Logger running status	1.Light off: Running abnormally. 2.On 1s/Off 1s (Slow flash): Running normally. 3.On 100ms/Off 100ms(Fast flash): Restore factory settings.

The normal operation status of the stick logger, when router connected to the network normally:

- 1.Connection to the server succeeded: NET light keeps on after the logger powered on.
- 2.Logger running normally: READY light flashes.
- 3.Connection to the inverter succeeded: COM light keeps on.

3. Abnormal State Processing

If the data on platform is abnormal when the stick logger is running, please check the table below and according to the status of indicator lights to complete a simple troubleshooting. If it still can not be resolved or indicator lights status do not show in the table below, please contact Customer Support.

(Note: Please using the following table query after power-on for 2mins at least.)

NET	COM	READY	Fault Description	Fault Cause	Solution
NET	COM	READY			
Any state	OFF	Slow flash	Communication with inverter abnormal	1.Connection between stick logger and inverter loosen. 2.Inverter does not match with stick logger's communication rate.	1.Check the connection between stick logger and inverter. Remove the stick logger and install again. 2.Check inverter's communication rate to see if it matches with stick logger's. 3.Long press Reset button for 5s, reboot stick logger.
OFF	ON	Slow flash	Connection between logger and router abnormal	1.Stick logger does not have a network. 2.Antenna abnormal 3.Router WiFi signal strength weak.	1.Check if the wireless network configured. 2.Check the antenna, if there is any damage or loose. 3.Enhance router WiFi signal strength. 4.Long press Resetbutton for 10s, reboot stick logger and networking again.
Slow flash	ON	Slow flash	Connection between logger and router normal, connection between logger and remote server abnormal.	1.Router networking abnormal. 2.The server point of logger is modified. 3.Network limitation, server cannot be connected.	1.Check if the router has access to the network. 2.Check the router's setting, if the connection is limited. 3.Contact our customer service.
OFF	OFF	OFF	Power supply abnormal	1.Connection between stick logger and inverter loosen or abnormal. 2.Inverter power insufficient. 3.Stick Logger abnormal.	1.Check the connection, remove the stick logger and install again. 2.Check inverter output power. 3.Contact our customer service.
Fast flash	Any state	Any state	SMARTLINK networking status	Normal	1.Exit automatically after 5mins. 2.Long press Reset button for 5s, reboot stick logger. 3.Long press Reset button for 10s, restore factory settings.
Any state	Any state	Fast flash	Restore factory settings	Normal	1.Exit automatically after 1mins. 2.Long press Reset button for 5s, reboot stick logger. 3.Long press Reset button for 10s, restore factory settings.

4. Usage methods and notices for Reset button

4.1 Usage methods and key-press descriptions for Reset button

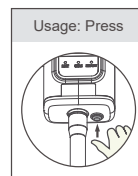

Key-press	Status Description	Light Status
Short press 1s	SMARTLINK rapid networking status	NET light flashes fast for 100ms.
Long press 5s	Rebooting the stick logger.	All lights are extinguished immediately.
Long press 10s	Resetting the stick logger.	1.All lights are extinguished after 4s. 2.READY light flashes fast for 100ms.

4.2 Notices for Reset button



USER MANUAL for SOLARMAN Smart APP

1.Registration

Go to SOLARMAN Smart and register. Click "Register" and create your account here.

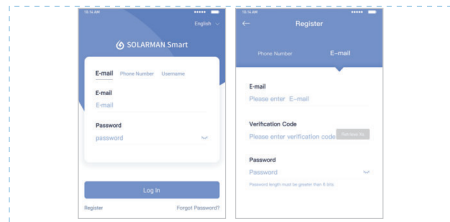

2.Create a Plant

Click "Add Now" to create your plant. Please fill in plant basic info and other info here.

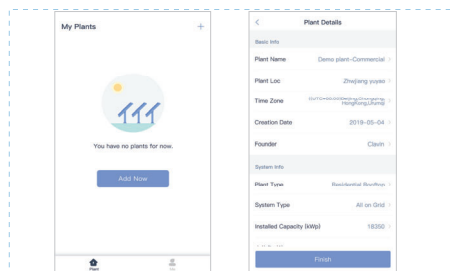

3.Add a Logger

Method 1: Enter logger SN manually.

Method 2: Click the icon in the right and scan to enter logger SN
You can find logger SN in the external packaging or on the logger body.

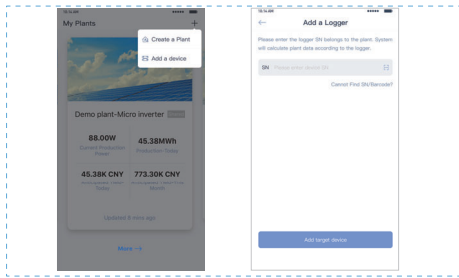

4.Network Configuration

After the logger is added, please configure the network to ensure normal operation.
Go to "Plant Details"->"Device List", find the target SN and click "Networking".

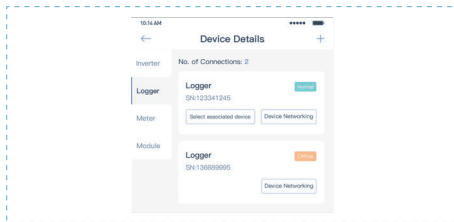

Step 1: Confirm Wi-Fi Info

Please make sure your phone has connected to the right WiFi network. And click "Start".

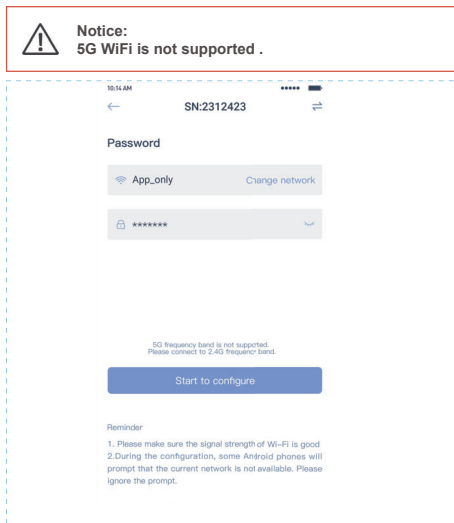

Step 2: Connect to AP network

Click "Go to connect" and find the right "AP_XXXXX" network (XXXXX refers to logger SN).
If the password is required, you can find the password on the logger body.

Go back to SOLARMAN Smart APP, after connecting to AP network.

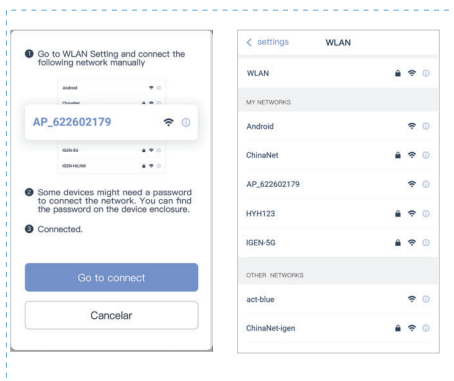

Step 3: Auto Configuration

Please wait for a while to complete the configuration. Then system will switch to the following page.
Click "Done" to check plant data. (Usually, the data will be updated in 10 mins)

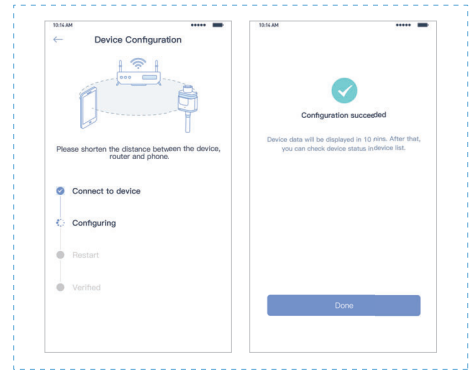

If configuration failure occurs, please check the following reason and try it again.

- (1) Make sure WLAN is ON.
- (2) Make sure WiFi is normal.
- (3) Make sure wireless router does not implement the white-black list.
- (4) Remove the special characters in Wi-Fi network.
- (5) Shorten the distance between the phone and device.
- (6) Try to connect to other Wi-Fi.

11. Generator Use Operation Guide

11.1 Generator Use Diagram

1) The Generator is connected to the grid port of the inverter. The connecting cable shall be covered with CT. It is used in some off grid situations. The system diagram is as follows.

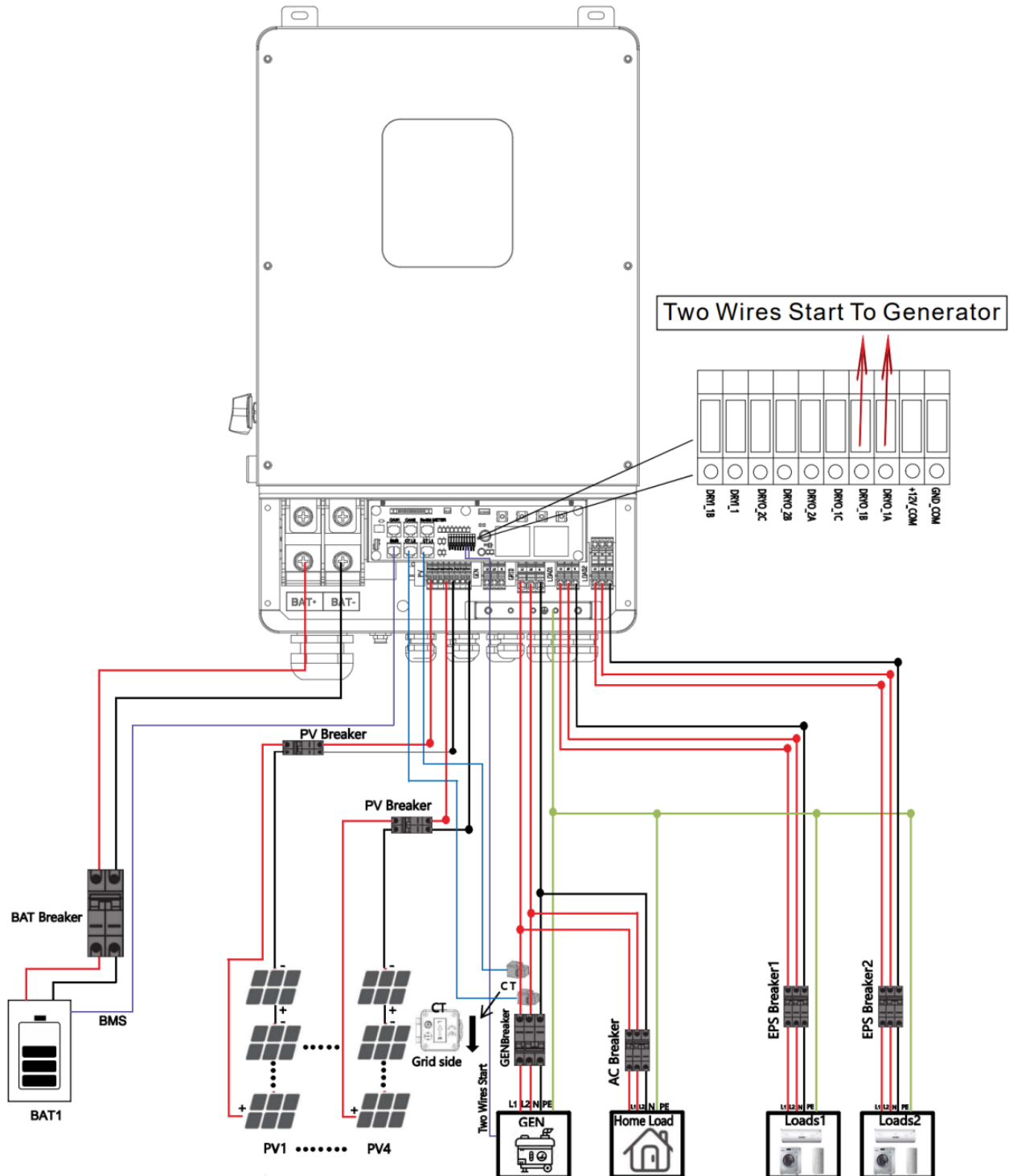

2) The Generator is normally connected to the Generator port. The connecting cable between the Generator and the inverter does not need to be covered with CT. The connection line of the power grid port should be connected with CT. The system diagram is as follows.

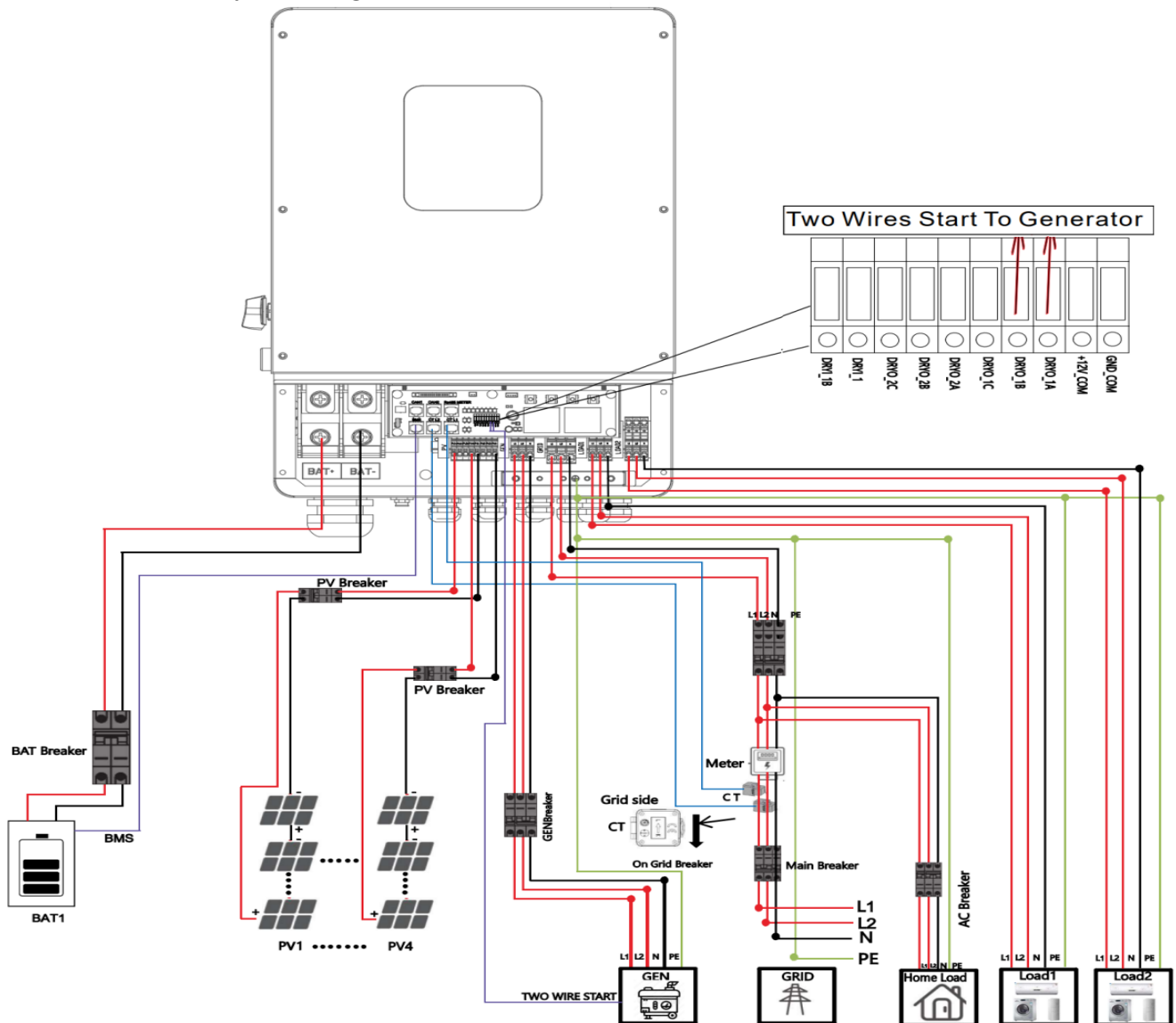

11.2 Generator Operation Notes

1) The two wire start signal **DRYO_1A** and **DRYO_1B** of the Generator is used to automatically control the start and stop of the Generator.

2) Make sure the inverter units software version support Generator function.

USER->INQUIRE->FIRMWARE

Note: If unsure of firmware version needed, contact your distributor

FIRMWARE	
ARM:	V1.XX.XX
DSP:	V1.XX.XX

3) When the generator is used in inverter parallel situation, the two wires start signal is only needed to be connected to the master unit. The wiring and the setting of the Generator should be exactly same.

4) Please check the diagram above .

11.3 Generator Setting

The Generator setting page can be visited in the following steps in the screen:
USER->1. SETUP->PASSORD CHECK->16.Generator

11.3.1 Setting

Interface	Description
Generator 1.START SOC 2.STOP SOC 3.ChgCurrToBAT 4.MAX RUN TIME 5.COOLDOWN 6.CONTRL 7.POWER	This interface shows Generator setting. <ol style="list-style-type: none"> When the SOC of battery is lower than the setpoint, the Generator drycontact is enabled and Generator Manual operation is disabled, the connected Generator will be started. When the SOC of battery is higher than the setpoint, the Generator drycontact is enabled and Generator Manual operation is disabled, the connected Generator will be stopped. It indicates the maximum current that the inverter charges the battery from Generator. It indicates the longest time Generator can run in one day, when time is up, the Generator will be turned off. The value 240 means 24hours in which state the Generator will not be shut down all the time. The unit is 0.1 hour. It indicates the waiting time of the Generator to restart after it has reached the running time.The unit is 0.1 hour. Refer to 11.3.2 CONTRL. Rated power of Generator.

11.3.2 CONTROL

Interface	Description
GEN CONTROL 1.Generator En 2.Charge En 3.AutoCtrl En 4.Manual En 5.ManualCmd En 6.Connect Grid	This interface shows Generator CONTRL. <ol style="list-style-type: none"> Enable control of the Generator function. Generator Charge Enable control If the user wants the Generator to be automatically controlled to start and stop through the dry contact,Enable it. If the user wants the Generator to be controlled manually,Enable it. Manual En should be opposed to AutoCtrl En. The on/off command in manual control mode , Connect the diesel Generator to the grid input port.

12. Advanced Mode Operation Guide

12.1 Advanced Mode Introduction

The hybrid inverter can be programmed to control how and when to use grid power. The Advanced mode allow management of flexible loads and time-of-use billing.

There are three advanced mode available: **Sell First Mode, Limited Consumption Mode** and **Zero Export Mode**.

Sell First Mode: In this mode the anti-reflux setting is automatically disabled. The users can use this mode to sell back surplus solar power to grid. If time of use is enabled, the battery power can also be sold to grid.

Limited Consumption Mode: In this mode, the ct limiters are used to sense the grid power flow direction. The hybrid inverter can be choosed to sell power or not sell power to grid. There is a **CT Limit Power** parameter available in this mode. When the battery is needed to discharge to reduced the load consumption, the grid will cover the parameter set part consumption firstly and the battery discharges energy to makes up the rest part. Other conditions are similar to SELF CONSUME working mode.

Zero export Mode: In this mode, the ct limiters should be installed in the input of the inverter's grid port. **Caution:** Inverter does not support full *Zero Export* capability. Some power may be fed to the grid, especially due to surges.

There are also some attributes of these mode: **Global Grid Charge Enable, Pv Charge Only, Bat Charge On Priority , Time-of-use Enable** and **6 Time-of-use Slots**. The time slots parameters are shown in as below:

	Grid Charge	Gen Charge	Start Time		End Time		Bat Power	Bat SOC
Time Slot1	√		1 h	0 m	8 h	0 m	8000 W	50 %
Time Slot2			8 h	0 m	9 h	0 m	8000 W	100 %
Time Slot3	√		9 h	0 m	13 h	0 m	8000 W	100 %
Time Slot4			13 h	0 m	19 h	0 m	8000 W	15 %
Time Slot5	√		19 h	0 m	20 h	0 m	8000 W	100 %
Time Slot6	√		20 h	0 m	1 h	0 m	8000 W	100 %

Global Grid Charge Enable: It is a high level control attribute of grid charge enable. If time of use function is disabled, this attribute is used to judge whether or not to charge the battery by grid. If time of use function is enabled ,the battery can be charged by grid only when the

time slot grid charge attribute is enabled.

Pv Charge Only: If user doesn't want to use grid to charge the battery in any time ,please enable this attribute.

Bat Charge On Priority: If there will be a storm or other emergency, user can use this attribute to adjust the power distribution priority. If this attribute is disabled ,the solar power will cover the load on priority by default.

6 Time-of-use Slots: There are 6 slots which can be programmed. If grid charge/ generator charge is enable, the grid is used to power the load and charge the battery to target SOC at specific bat power attribute value.

12.2 Advanced Mode Setting

The Advanced Mode Settings page can be accessed through the following steps on the screen:

USER->1. SETUP->PASSORD CHECK->16.ADVAN SET

12.2.1 Setting

Interface	Description
--ADVAN SET-- -- > 1.Mode Set 2.Advan Ctrl 3.TOU Set 4.CT Limit 5.Grid Power	This interface displays advanced mode settings. 1. ->Inverter working mode setting. 2. ->Inverter related function control. See 12.2.3 Advan Ctrl for details. 3.->Time of use setting. See 12.2.4 Time of use for details. 4.->The CT will detect power flowing back to the grid and Limit the grid output according to the set value. 5.->Maximum power entering household power grid.

12.2.2 Work Mode

Interface	Description
--MODE SET-- -- > 1.Disable 2.Sell First 3.Limit Grid 4.Zero Export	1.->Disable advanced mode.

12.2.3 Advan Ctrl

Interface	Description
<div style="border: 1px solid black; padding: 5px; margin-bottom: 10px;"> --ADVAN CONTROL-- -- > 1. Grid Chg En 2. TOU En 3. BAT Prio 4. PVChgOnly </div>	1.->Global control, whether the power grid can charge the battery. 2.->Whether TIME OF USE is enabled 3.->PV energy is firstly used to charge the battery and then used to power the load. If PV power is insufficient, grid will make supplement for battery and load simultaneously. 4.->The battery is charged only by PV, and cannot be charged by the grid.

12.2.4 Time Of Use

Interface	Description
<div style="border: 1px solid black; padding: 5px; margin-bottom: 10px;"> --SLOT-- -- > 1. Slot 2. GridChg 3. GeneratorChg </div> <div style="border: 1px solid black; padding: 5px;"> Start: 00:00 End: 00:00 Power: 00.0KW SOC: 0% </div>	1.->From the start time to the end time, charge the battery with the written Power to the written SOC. If GridChg is enabled, allow the grid to charge, and if GeneratorChg is enabled, allow the generator to generate power for the battery. 2.->In the slot section, control the grid to charge the battery. 3.->In the slot section, control the generator to charge the battery.

Abbreviations

- AWG – American Wire Gauge
- A – Amp(s)
- Ah – Amp hour(s)
- AC – Alternating Current
- AHJ – Authority Having Jurisdiction
- ANSI – American National Standards Institute
- BMS – Battery Management System
- DC – Direct Current
- DIP – Dual In-line Package
- DOD – Depth of Discharge
- EG – Equipment Ground
- EGS – Equipment Grounding System
- EPS – Emergency Power System
- ESS – Energy Storage System
- E-Stop NO – Emergency Stop Normally Open
- GE – Grounding Electrode
- GEC – Grounding Electrode Conductor
- GES – Grounding Electrode System
- In. lbs. – Inch Pounds
- kW – Kilowatt
- kWh – Kilowatt-hour
- LFP – Lithium Iron Phosphate or LiFePO₄
- mm – Millimeter(s)
- mV – Millivolt(s)
- NEC – National Electrical Code
- NFPA – National Fire Prevention Association
- Nm – Newton meters
- PC – Personal Computer
- PCB – Printed Circuit Board
- PE – Protective Earth (G or Ground)
- PPE – Personal Protective Equipment
- PV – Photovoltaic
- RSD – Rapid Shut Down
- SOC – State of Charge
- STC – Standard Testing Conditions
- V – Volt(s)